









Assembly code	Assembly revision	Assembly image
ASM1766A/0.D02	Cooking chamber	
ASM1776A/0.D04	External cover	
ASM1854A/0.D02	General overview	
ASM3008A/0.D06	Door	

ASM1766A/0.D02 - Cooking chamber

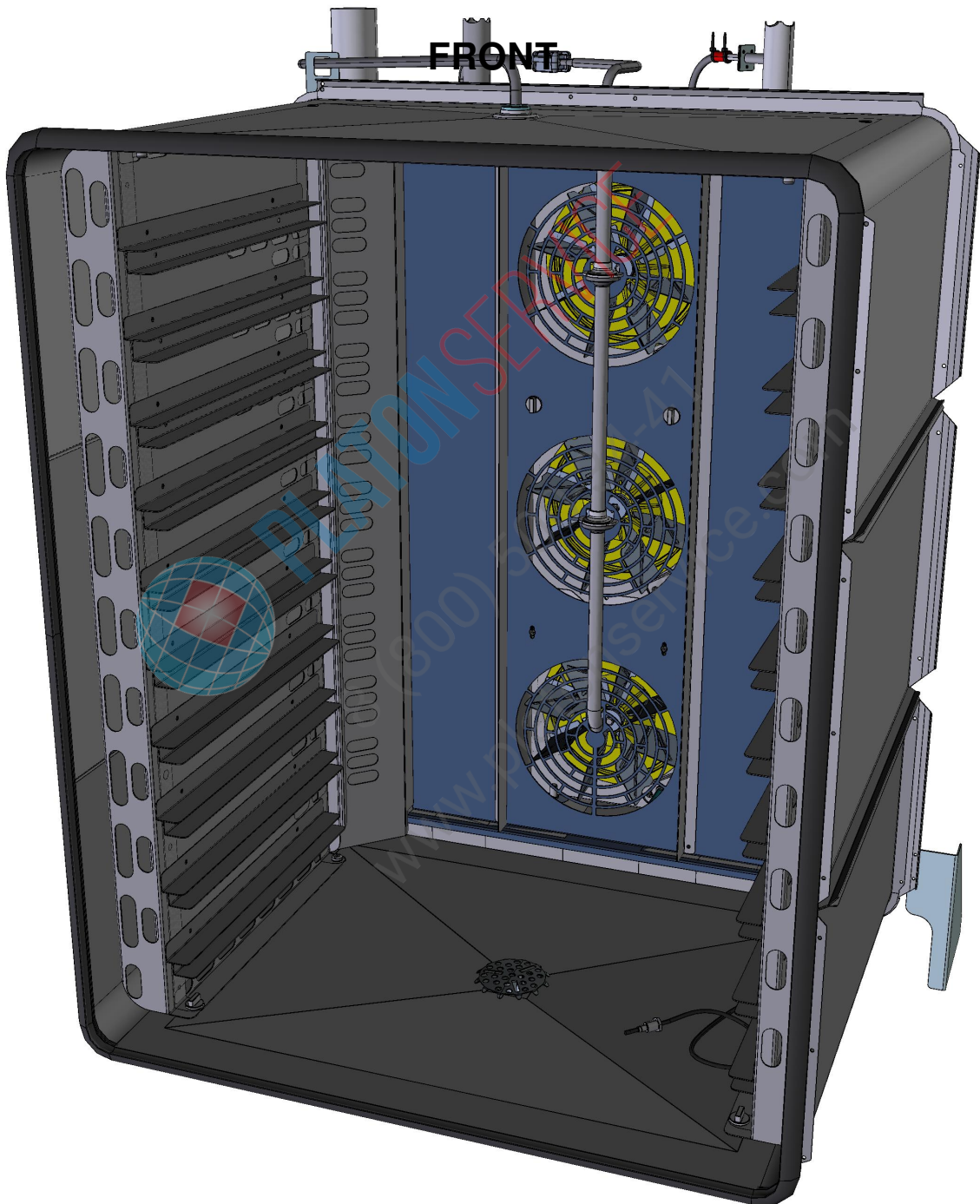

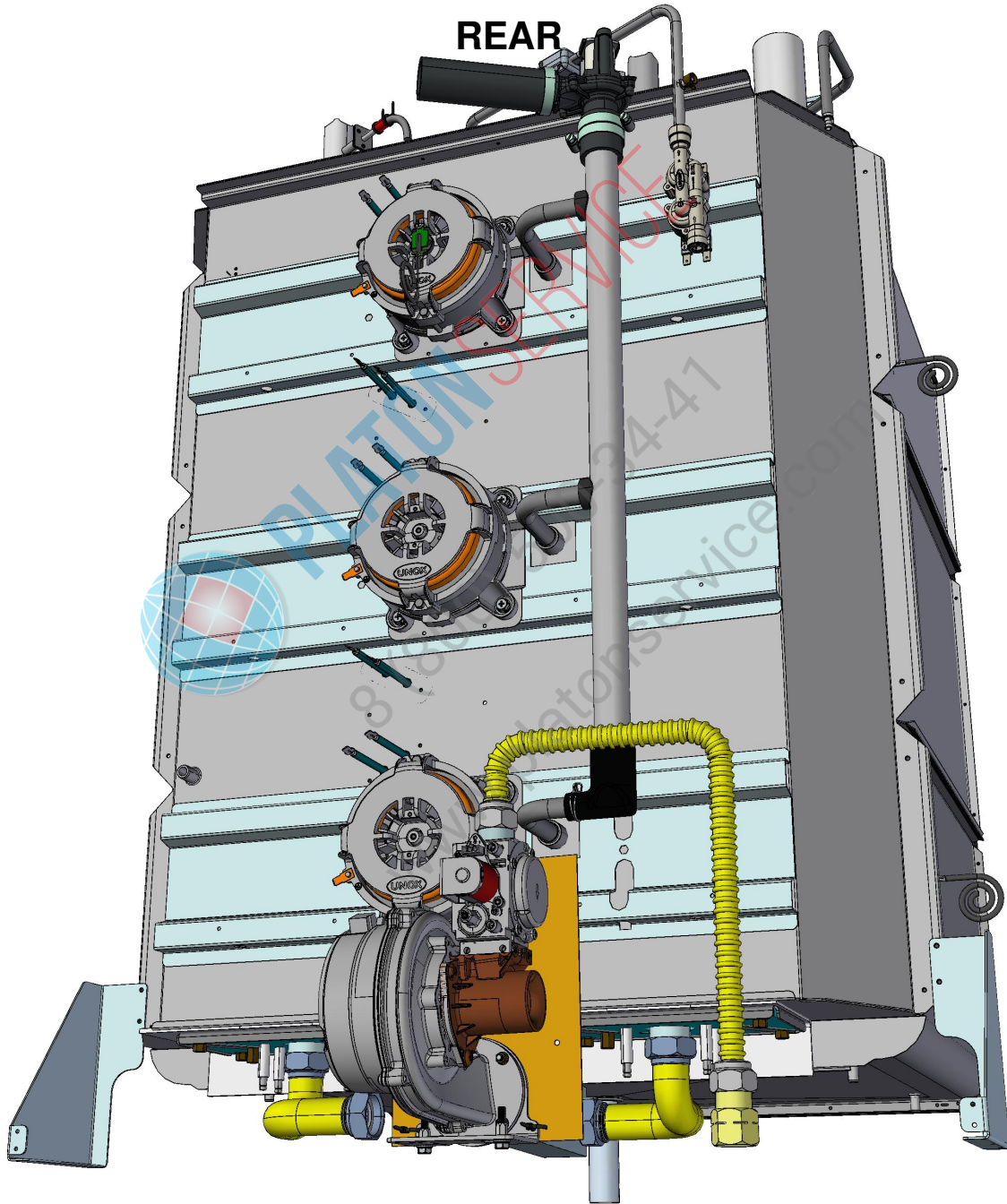
ASM1766A/0.D02 - Cooking chamber

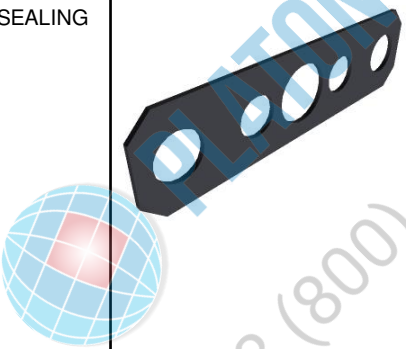

COMPONENT			SPARE PART																										
Code	Description	Image	Code	Description	Components list																								
RS1215A	147W 105V BRAKING ELEMENT		KRS1215A	147W MOTOR BRAKING ELEMENT KIT	<table border="1"> <thead> <tr> <th>Code</th> <th>Description</th> <th>Qty</th> <th>UOM</th> </tr> </thead> <tbody> <tr> <td>GN1326A1</td> <td>ELEMENT SEALING</td> <td>1</td> <td>PZ</td> </tr> <tr> <td>RS1215A1</td> <td>147W 105V BRAKING ELEMENT</td> <td>1</td> <td>PZ</td> </tr> <tr> <td>SL1045A0</td> <td>S53 BLACK SILICONE - 80ML CARTRIDGE</td> <td>1</td> <td>PZ</td> </tr> <tr> <td>VI1220A1</td> <td>4,2X12 TCB SELF-TAPPIN G SCREW</td> <td>2</td> <td>PZ</td> </tr> <tr> <td>VM2147A0</td> <td>ESD SPONGE PINK SMOOTH 410X343X15 M</td> <td>1</td> <td>PZ</td> </tr> </tbody> </table>	Code	Description	Qty	UOM	GN1326A1	ELEMENT SEALING	1	PZ	RS1215A1	147W 105V BRAKING ELEMENT	1	PZ	SL1045A0	S53 BLACK SILICONE - 80ML CARTRIDGE	1	PZ	VI1220A1	4,2X12 TCB SELF-TAPPIN G SCREW	2	PZ	VM2147A0	ESD SPONGE PINK SMOOTH 410X343X15 M	1	PZ
					Code	Description	Qty	UOM																					
GN1326A1	ELEMENT SEALING	1	PZ																										
RS1215A1	147W 105V BRAKING ELEMENT	1	PZ																										
SL1045A0	S53 BLACK SILICONE - 80ML CARTRIDGE	1	PZ																										
VI1220A1	4,2X12 TCB SELF-TAPPIN G SCREW	2	PZ																										
VM2147A0	ESD SPONGE PINK SMOOTH 410X343X15 M	1	PZ																										
GN1326A	ELEMENT SEALING		KRS1261A	122W MOTOR BREAKING ELEMENT KIT	<table border="1"> <thead> <tr> <th>Code</th> <th>Description</th> <th>Qty</th> <th>UOM</th> </tr> </thead> <tbody> <tr> <td>GN1326A1</td> <td>ELEMENT SEALING</td> <td>1</td> <td>PZ</td> </tr> <tr> <td>RS1261A0</td> <td>BAKERLUX/CH EFLUX MOTOR BREAKING ELEMENT</td> <td>1</td> <td>PZ</td> </tr> <tr> <td>SL1045A0</td> <td>S53 BLACK SILICONE - 80ML CARTRIDGE</td> <td>1</td> <td>PZ</td> </tr> <tr> <td>VI1220A1</td> <td>4,2X12 TCB SELF-TAPPIN G SCREW</td> <td>2</td> <td>PZ</td> </tr> <tr> <td>VM2147A0</td> <td>ESD SPONGE PINK SMOOTH 410X343X15 M</td> <td>1</td> <td>PZ</td> </tr> </tbody> </table>	Code	Description	Qty	UOM	GN1326A1	ELEMENT SEALING	1	PZ	RS1261A0	BAKERLUX/CH EFLUX MOTOR BREAKING ELEMENT	1	PZ	SL1045A0	S53 BLACK SILICONE - 80ML CARTRIDGE	1	PZ	VI1220A1	4,2X12 TCB SELF-TAPPIN G SCREW	2	PZ	VM2147A0	ESD SPONGE PINK SMOOTH 410X343X15 M	1	PZ
Code	Description	Qty	UOM																										
GN1326A1	ELEMENT SEALING	1	PZ																										
RS1261A0	BAKERLUX/CH EFLUX MOTOR BREAKING ELEMENT	1	PZ																										
SL1045A0	S53 BLACK SILICONE - 80ML CARTRIDGE	1	PZ																										
VI1220A1	4,2X12 TCB SELF-TAPPIN G SCREW	2	PZ																										
VM2147A0	ESD SPONGE PINK SMOOTH 410X343X15 M	1	PZ																										
			KRS1215A	147W MOTOR BRAKING ELEMENT KIT	<table border="1"> <thead> <tr> <th>Code</th> <th>Description</th> <th>Qty</th> <th>UOM</th> </tr> </thead> <tbody> <tr> <td>GN1326A1</td> <td>ELEMENT SEALING</td> <td>1</td> <td>PZ</td> </tr> <tr> <td>RS1215A1</td> <td>147W 105V BRAKING ELEMENT</td> <td>1</td> <td>PZ</td> </tr> <tr> <td>SL1045A0</td> <td>S53 BLACK SILICONE - 80ML CARTRIDGE</td> <td>1</td> <td>PZ</td> </tr> <tr> <td>VI1220A1</td> <td>4,2X12 TCB SELF-TAPPIN G SCREW</td> <td>2</td> <td>PZ</td> </tr> <tr> <td>VM2147A0</td> <td>ESD SPONGE PINK SMOOTH 410X343X15 M</td> <td>1</td> <td>PZ</td> </tr> </tbody> </table>	Code	Description	Qty	UOM	GN1326A1	ELEMENT SEALING	1	PZ	RS1215A1	147W 105V BRAKING ELEMENT	1	PZ	SL1045A0	S53 BLACK SILICONE - 80ML CARTRIDGE	1	PZ	VI1220A1	4,2X12 TCB SELF-TAPPIN G SCREW	2	PZ	VM2147A0	ESD SPONGE PINK SMOOTH 410X343X15 M	1	PZ
Code	Description	Qty	UOM																										
GN1326A1	ELEMENT SEALING	1	PZ																										
RS1215A1	147W 105V BRAKING ELEMENT	1	PZ																										
SL1045A0	S53 BLACK SILICONE - 80ML CARTRIDGE	1	PZ																										
VI1220A1	4,2X12 TCB SELF-TAPPIN G SCREW	2	PZ																										
VM2147A0	ESD SPONGE PINK SMOOTH 410X343X15 M	1	PZ																										

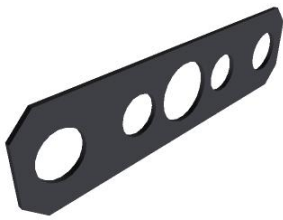

COMPONENT			SPARE PART																																		
Code	Description	Image	Code	Description	Components list																																
GN1326A	ELEMENT SEALING		KRS1095A	1.2KW HEATING ELEMENT KIT	<table border="1"> <thead> <tr> <th>Code</th> <th>Description</th> <th>Qty</th> <th>UOM</th> </tr> </thead> <tbody> <tr> <td>GN1326A1</td> <td>ELEMENT SEALING</td> <td>1</td> <td>PZ</td> </tr> <tr> <td>IP1385A0</td> <td></td> <td>1.200</td> <td>PZ</td> </tr> <tr> <td>IP1385A1</td> <td>CORNER POLYSTYRENE PACKING 110X80X2000</td> <td>0.500</td> <td>M</td> </tr> <tr> <td>RS1095A1</td> <td>HEATING ELEMENT 1200W 230V</td> <td>1</td> <td>PZ</td> </tr> <tr> <td>SL1045A0</td> <td>S53 BLACK SILICONE - 80ML CARTRIDGE</td> <td>1</td> <td>PZ</td> </tr> <tr> <td>VI1220A1</td> <td>4,2X12 TCB SELF-TAPPING SCREW</td> <td>2</td> <td>PZ</td> </tr> <tr> <td>VM1059A1</td> <td>HEAT SHRINK FILM H800</td> <td>1.200</td> <td>M</td> </tr> </tbody> </table>	Code	Description	Qty	UOM	GN1326A1	ELEMENT SEALING	1	PZ	IP1385A0		1.200	PZ	IP1385A1	CORNER POLYSTYRENE PACKING 110X80X2000	0.500	M	RS1095A1	HEATING ELEMENT 1200W 230V	1	PZ	SL1045A0	S53 BLACK SILICONE - 80ML CARTRIDGE	1	PZ	VI1220A1	4,2X12 TCB SELF-TAPPING SCREW	2	PZ	VM1059A1	HEAT SHRINK FILM H800	1.200	M
			Code	Description	Qty	UOM																															
			GN1326A1	ELEMENT SEALING	1	PZ																															
IP1385A0		1.200	PZ																																		
IP1385A1	CORNER POLYSTYRENE PACKING 110X80X2000	0.500	M																																		
RS1095A1	HEATING ELEMENT 1200W 230V	1	PZ																																		
SL1045A0	S53 BLACK SILICONE - 80ML CARTRIDGE	1	PZ																																		
VI1220A1	4,2X12 TCB SELF-TAPPING SCREW	2	PZ																																		
VM1059A1	HEAT SHRINK FILM H800	1.200	M																																		
KRS1012A	1365W 120V HEATING ELEMENT KIT	<table border="1"> <thead> <tr> <th>Code</th> <th>Description</th> <th>Qty</th> <th>UOM</th> </tr> </thead> <tbody> <tr> <td>GN1326A1</td> <td>ELEMENT SEALING</td> <td>1</td> <td>PZ</td> </tr> <tr> <td>RS1012A0</td> <td>CIRCULAR ELEMENT 1365W 120V</td> <td>1</td> <td>PZ</td> </tr> <tr> <td>VI1220A1</td> <td>4,2X12 TCB SELF-TAPPING SCREW</td> <td>5</td> <td>PZ</td> </tr> <tr> <td>VM1794A0</td> <td>250X4.8 PA66 BLACK CLAMP</td> <td>2</td> <td>PZ</td> </tr> <tr> <td>VM2103A0</td> <td>CLAMP LOCK</td> <td>2</td> <td>PZ</td> </tr> </tbody> </table>	Code	Description	Qty	UOM	GN1326A1	ELEMENT SEALING	1	PZ	RS1012A0	CIRCULAR ELEMENT 1365W 120V	1	PZ	VI1220A1	4,2X12 TCB SELF-TAPPING SCREW	5	PZ	VM1794A0	250X4.8 PA66 BLACK CLAMP	2	PZ	VM2103A0	CLAMP LOCK	2	PZ											
Code	Description	Qty	UOM																																		
GN1326A1	ELEMENT SEALING	1	PZ																																		
RS1012A0	CIRCULAR ELEMENT 1365W 120V	1	PZ																																		
VI1220A1	4,2X12 TCB SELF-TAPPING SCREW	5	PZ																																		
VM1794A0	250X4.8 PA66 BLACK CLAMP	2	PZ																																		
VM2103A0	CLAMP LOCK	2	PZ																																		
KRS1011A	ROBERTA/LISA HEATING ELEMENT KIT	<table border="1"> <thead> <tr> <th>Code</th> <th>Description</th> <th>Qty</th> <th>UOM</th> </tr> </thead> <tbody> <tr> <td>GN1326A1</td> <td>ELEMENT SEALING</td> <td>1</td> <td>PZ</td> </tr> <tr> <td>RS1011A0</td> <td>2560W 220-230V HEATING ELEMENT</td> <td>1</td> <td>PZ</td> </tr> <tr> <td>SL1045A0</td> <td>S53 BLACK SILICONE - 80ML CARTRIDGE</td> <td>1</td> <td>PZ</td> </tr> <tr> <td>VI1220A1</td> <td>4,2X12 TCB SELF-TAPPING SCREW</td> <td>5</td> <td>PZ</td> </tr> <tr> <td>VM1794A0</td> <td>250X4.8 PA66 BLACK CLAMP</td> <td>2</td> <td>PZ</td> </tr> <tr> <td>VM2103A0</td> <td>CLAMP LOCK</td> <td>2</td> <td>PZ</td> </tr> </tbody> </table>	Code	Description	Qty	UOM	GN1326A1	ELEMENT SEALING	1	PZ	RS1011A0	2560W 220-230V HEATING ELEMENT	1	PZ	SL1045A0	S53 BLACK SILICONE - 80ML CARTRIDGE	1	PZ	VI1220A1	4,2X12 TCB SELF-TAPPING SCREW	5	PZ	VM1794A0	250X4.8 PA66 BLACK CLAMP	2	PZ	VM2103A0	CLAMP LOCK	2	PZ							
Code	Description	Qty	UOM																																		
GN1326A1	ELEMENT SEALING	1	PZ																																		
RS1011A0	2560W 220-230V HEATING ELEMENT	1	PZ																																		
SL1045A0	S53 BLACK SILICONE - 80ML CARTRIDGE	1	PZ																																		
VI1220A1	4,2X12 TCB SELF-TAPPING SCREW	5	PZ																																		
VM1794A0	250X4.8 PA66 BLACK CLAMP	2	PZ																																		
VM2103A0	CLAMP LOCK	2	PZ																																		
KRS0090A	HEATING ELEMENT 1.26KW	<table border="1"> <thead> <tr> <th>Code</th> <th>Description</th> <th>Qty</th> <th>UOM</th> </tr> </thead> <tbody> <tr> <td>GN1326A1</td> <td>ELEMENT SEALING</td> <td>1</td> <td>PZ</td> </tr> </tbody> </table>	Code	Description	Qty	UOM	GN1326A1	ELEMENT SEALING	1	PZ																											
Code	Description	Qty	UOM																																		
GN1326A1	ELEMENT SEALING	1	PZ																																		

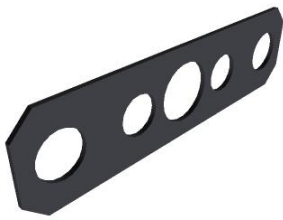
COMPONENT			SPARE PART																							
Code	Description	Image	Code	Description	Components list																					
GN1326A	ELEMENT SEALING		KRS0090A	HEATING ELEMENT 1.26KW	<table border="1"> <thead> <tr> <th>Code</th> <th>Description</th> <th>Qty</th> <th>UOM</th> </tr> </thead> <tbody> <tr> <td>RS0090A0</td> <td>CIRC. HEAT. ELEMENT 1260W 220-230</td> <td>1</td> <td>PZ</td> </tr> <tr> <td>VI1220A1</td> <td>4,2X12 TCB SELF-TAPPIN G SCREW</td> <td>3</td> <td>PZ</td> </tr> <tr> <td>VM1794A0</td> <td>250X4.8 PA66 BLACK CLAMP</td> <td>2</td> <td>PZ</td> </tr> <tr> <td>VM2103A0</td> <td>CLAMP LOCK</td> <td>2</td> <td>PZ</td> </tr> </tbody> </table>	Code	Description	Qty	UOM	RS0090A0	CIRC. HEAT. ELEMENT 1260W 220-230	1	PZ	VI1220A1	4,2X12 TCB SELF-TAPPIN G SCREW	3	PZ	VM1794A0	250X4.8 PA66 BLACK CLAMP	2	PZ	VM2103A0	CLAMP LOCK	2	PZ	
			Code	Description	Qty	UOM																				
			RS0090A0	CIRC. HEAT. ELEMENT 1260W 220-230	1	PZ																				
			VI1220A1	4,2X12 TCB SELF-TAPPIN G SCREW	3	PZ																				
VM1794A0	250X4.8 PA66 BLACK CLAMP	2	PZ																							
VM2103A0	CLAMP LOCK	2	PZ																							
KRS0050A	HEATING ELEMENT KIT 0.5KW	<table border="1"> <thead> <tr> <th>Code</th> <th>Description</th> <th>Qty</th> <th>UOM</th> </tr> </thead> <tbody> <tr> <td>GN1326A1</td> <td>ELEMENT SEALING</td> <td>1</td> <td>PZ</td> </tr> <tr> <td>IP1075A1</td> <td></td> <td>1</td> <td>PZ</td> </tr> <tr> <td>IP1080A1</td> <td></td> <td>1</td> <td>PZ</td> </tr> <tr> <td>RS0050A0</td> <td>HEAT. ELEMENT 500W 220-230V LIEV</td> <td>1</td> <td>PZ</td> </tr> <tr> <td>VI1220A1</td> <td>4,2X12 TCB SELF-TAPPIN G SCREW</td> <td>2</td> <td>PZ</td> </tr> </tbody> </table>	Code	Description	Qty	UOM	GN1326A1	ELEMENT SEALING	1	PZ	IP1075A1		1	PZ	IP1080A1		1	PZ	RS0050A0	HEAT. ELEMENT 500W 220-230V LIEV	1	PZ	VI1220A1	4,2X12 TCB SELF-TAPPIN G SCREW	2	PZ
Code	Description	Qty	UOM																							
GN1326A1	ELEMENT SEALING	1	PZ																							
IP1075A1		1	PZ																							
IP1080A1		1	PZ																							
RS0050A0	HEAT. ELEMENT 500W 220-230V LIEV	1	PZ																							
VI1220A1	4,2X12 TCB SELF-TAPPIN G SCREW	2	PZ																							
KRS0011A	HEATING ELEMENT 1.465KW RS0011A	<table border="1"> <thead> <tr> <th>Code</th> <th>Description</th> <th>Qty</th> <th>UOM</th> </tr> </thead> <tbody> <tr> <td>GN1326A1</td> <td>ELEMENT SEALING</td> <td>1</td> <td>PZ</td> </tr> <tr> <td>RS0011A0</td> <td>CIRC.HEAT. ELEMENT 1465W 220-230</td> <td>1</td> <td>PZ</td> </tr> <tr> <td>VI1220A1</td> <td>4,2X12 TCB SELF-TAPPIN G SCREW</td> <td>3</td> <td>PZ</td> </tr> <tr> <td>VM1794A0</td> <td>250X4.8 PA66 BLACK CLAMP</td> <td>2</td> <td>PZ</td> </tr> <tr> <td>VM2103A0</td> <td>CLAMP LOCK</td> <td>2</td> <td>PZ</td> </tr> </tbody> </table>	Code	Description	Qty	UOM	GN1326A1	ELEMENT SEALING	1	PZ	RS0011A0	CIRC.HEAT. ELEMENT 1465W 220-230	1	PZ	VI1220A1	4,2X12 TCB SELF-TAPPIN G SCREW	3	PZ	VM1794A0	250X4.8 PA66 BLACK CLAMP	2	PZ	VM2103A0	CLAMP LOCK	2	PZ
Code	Description	Qty	UOM																							
GN1326A1	ELEMENT SEALING	1	PZ																							
RS0011A0	CIRC.HEAT. ELEMENT 1465W 220-230	1	PZ																							
VI1220A1	4,2X12 TCB SELF-TAPPIN G SCREW	3	PZ																							
VM1794A0	250X4.8 PA66 BLACK CLAMP	2	PZ																							
VM2103A0	CLAMP LOCK	2	PZ																							
KRS0010A	KIT HEATING ELEMENT RS10010A	<table border="1"> <thead> <tr> <th>Code</th> <th>Description</th> <th>Qty</th> <th>UOM</th> </tr> </thead> <tbody> <tr> <td>GN1326A1</td> <td>ELEMENT SEALING</td> <td>1</td> <td>PZ</td> </tr> <tr> <td>IP1075A1</td> <td></td> <td>1</td> <td>PZ</td> </tr> <tr> <td>IP1080A1</td> <td></td> <td>5</td> <td>PZ</td> </tr> <tr> <td>RS0010A0</td> <td>CIRC.HEAT. ELEMENT 2560W - 220-230 V</td> <td>1</td> <td>PZ</td> </tr> <tr> <td>VI1220A1</td> <td>4,2X12 TCB SELF-TAPPIN G SCREW</td> <td>3</td> <td>PZ</td> </tr> </tbody> </table>	Code	Description	Qty	UOM	GN1326A1	ELEMENT SEALING	1	PZ	IP1075A1		1	PZ	IP1080A1		5	PZ	RS0010A0	CIRC.HEAT. ELEMENT 2560W - 220-230 V	1	PZ	VI1220A1	4,2X12 TCB SELF-TAPPIN G SCREW	3	PZ
Code	Description	Qty	UOM																							
GN1326A1	ELEMENT SEALING	1	PZ																							
IP1075A1		1	PZ																							
IP1080A1		5	PZ																							
RS0010A0	CIRC.HEAT. ELEMENT 2560W - 220-230 V	1	PZ																							
VI1220A1	4,2X12 TCB SELF-TAPPIN G SCREW	3	PZ																							
KG1326A	HEATING ELEMENT GASKET 5 PCS KIT	<table border="1"> <thead> <tr> <th>Code</th> <th>Description</th> <th>Qty</th> <th>UOM</th> </tr> </thead> <tbody> <tr> <td>GN1326A1</td> <td>ELEMENT SEALING</td> <td>5</td> <td>PZ</td> </tr> </tbody> </table>	Code	Description	Qty	UOM	GN1326A1	ELEMENT SEALING	5	PZ																
Code	Description	Qty	UOM																							
GN1326A1	ELEMENT SEALING	5	PZ																							





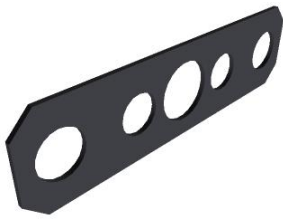

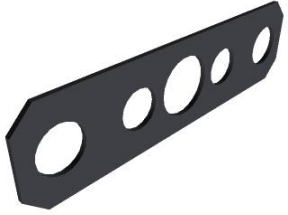

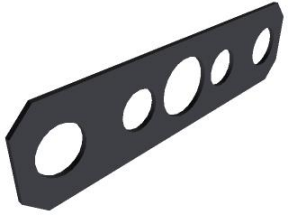

COMPONENT			SPARE PART																															
Code	Description	Image	Code	Description	Components list																													
GN1326A	ELEMENT SEALING		KRS1261A	122W MOTOR BRAKING ELEMENT KIT	<table border="1"> <thead> <tr> <th>Code</th> <th>Description</th> <th>Qty</th> <th>UOM</th> </tr> </thead> <tbody> <tr> <td>GN1326A1</td> <td>ELEMENT SEALING</td> <td>1</td> <td>PZ</td> </tr> <tr> <td>RS1261A0</td> <td>BAKERLUX/CH EFLUX MOTOR BRAKING ELEMENT</td> <td>1</td> <td>PZ</td> </tr> <tr> <td>SL1045A0</td> <td>S53 BLACK SILICONE - 80ML CARTRIDGE</td> <td>1</td> <td>PZ</td> </tr> <tr> <td>VI1220A1</td> <td>4,2X12 TCB SELF-TAPPIN G SCREW</td> <td>2</td> <td>PZ</td> </tr> <tr> <td>VM2147A0</td> <td>ESD SPONGE PINK SMOOTH 410X343X15 M</td> <td>1</td> <td>PZ</td> </tr> </tbody> </table>	Code	Description	Qty	UOM	GN1326A1	ELEMENT SEALING	1	PZ	RS1261A0	BAKERLUX/CH EFLUX MOTOR BRAKING ELEMENT	1	PZ	SL1045A0	S53 BLACK SILICONE - 80ML CARTRIDGE	1	PZ	VI1220A1	4,2X12 TCB SELF-TAPPIN G SCREW	2	PZ	VM2147A0	ESD SPONGE PINK SMOOTH 410X343X15 M	1	PZ					
			Code	Description	Qty	UOM																												
			GN1326A1	ELEMENT SEALING	1	PZ																												
RS1261A0	BAKERLUX/CH EFLUX MOTOR BRAKING ELEMENT	1	PZ																															
SL1045A0	S53 BLACK SILICONE - 80ML CARTRIDGE	1	PZ																															
VI1220A1	4,2X12 TCB SELF-TAPPIN G SCREW	2	PZ																															
VM2147A0	ESD SPONGE PINK SMOOTH 410X343X15 M	1	PZ																															
KRS1215A	147W MOTOR BRAKING ELEMENT KIT	<table border="1"> <thead> <tr> <th>Code</th> <th>Description</th> <th>Qty</th> <th>UOM</th> </tr> </thead> <tbody> <tr> <td>GN1326A1</td> <td>ELEMENT SEALING</td> <td>1</td> <td>PZ</td> </tr> <tr> <td>RS1215A1</td> <td>147W 105V BRAKING ELEMENT</td> <td>1</td> <td>PZ</td> </tr> <tr> <td>SL1045A0</td> <td>S53 BLACK SILICONE - 80ML CARTRIDGE</td> <td>1</td> <td>PZ</td> </tr> <tr> <td>VI1220A1</td> <td>4,2X12 TCB SELF-TAPPIN G SCREW</td> <td>2</td> <td>PZ</td> </tr> <tr> <td>VM2147A0</td> <td>ESD SPONGE PINK SMOOTH 410X343X15 M</td> <td>1</td> <td>PZ</td> </tr> </tbody> </table>	Code	Description	Qty	UOM	GN1326A1	ELEMENT SEALING	1	PZ	RS1215A1	147W 105V BRAKING ELEMENT	1	PZ	SL1045A0	S53 BLACK SILICONE - 80ML CARTRIDGE	1	PZ	VI1220A1	4,2X12 TCB SELF-TAPPIN G SCREW	2	PZ	VM2147A0	ESD SPONGE PINK SMOOTH 410X343X15 M	1	PZ								
Code	Description	Qty	UOM																															
GN1326A1	ELEMENT SEALING	1	PZ																															
RS1215A1	147W 105V BRAKING ELEMENT	1	PZ																															
SL1045A0	S53 BLACK SILICONE - 80ML CARTRIDGE	1	PZ																															
VI1220A1	4,2X12 TCB SELF-TAPPIN G SCREW	2	PZ																															
VM2147A0	ESD SPONGE PINK SMOOTH 410X343X15 M	1	PZ																															
KRS1095A	1.2KW HEATING ELEMENT KIT	<table border="1"> <thead> <tr> <th>Code</th> <th>Description</th> <th>Qty</th> <th>UOM</th> </tr> </thead> <tbody> <tr> <td>GN1326A1</td> <td>ELEMENT SEALING</td> <td>1</td> <td>PZ</td> </tr> <tr> <td>IP1385A0</td> <td></td> <td>1.200</td> <td>PZ</td> </tr> <tr> <td>IP1385A1</td> <td>CORNER POLYSTYREN E PACKING 110X80X2000</td> <td>0.500</td> <td>M</td> </tr> <tr> <td>RS1095A1</td> <td>HEATING ELEMENT 1200W 230V</td> <td>1</td> <td>PZ</td> </tr> <tr> <td>SL1045A0</td> <td>S53 BLACK SILICONE - 80ML CARTRIDGE</td> <td>1</td> <td>PZ</td> </tr> <tr> <td>VI1220A1</td> <td>4,2X12 TCB SELF-TAPPIN G SCREW</td> <td>2</td> <td>PZ</td> </tr> <tr> <td>VM1059A1</td> <td>HEAT SHRINK FILM H800</td> <td>1.200</td> <td>M</td> </tr> </tbody> </table>	Code	Description	Qty	UOM	GN1326A1	ELEMENT SEALING	1	PZ	IP1385A0		1.200	PZ	IP1385A1	CORNER POLYSTYREN E PACKING 110X80X2000	0.500	M	RS1095A1	HEATING ELEMENT 1200W 230V	1	PZ	SL1045A0	S53 BLACK SILICONE - 80ML CARTRIDGE	1	PZ	VI1220A1	4,2X12 TCB SELF-TAPPIN G SCREW	2	PZ	VM1059A1	HEAT SHRINK FILM H800	1.200	M
Code	Description	Qty	UOM																															
GN1326A1	ELEMENT SEALING	1	PZ																															
IP1385A0		1.200	PZ																															
IP1385A1	CORNER POLYSTYREN E PACKING 110X80X2000	0.500	M																															
RS1095A1	HEATING ELEMENT 1200W 230V	1	PZ																															
SL1045A0	S53 BLACK SILICONE - 80ML CARTRIDGE	1	PZ																															
VI1220A1	4,2X12 TCB SELF-TAPPIN G SCREW	2	PZ																															
VM1059A1	HEAT SHRINK FILM H800	1.200	M																															

COMPONENT			SPARE PART																														
Code	Description	Image	Code	Description	Components list																												
GN1326A	ELEMENT SEALING		KRS1012A	1365W 120V HEATING ELEMENT KIT	<table border="1"> <thead> <tr> <th>Code</th> <th>Description</th> <th>Qty</th> <th>UOM</th> </tr> </thead> <tbody> <tr> <td>GN1326A1</td> <td>ELEMENT SEALING</td> <td>1</td> <td>PZ</td> </tr> <tr> <td>RS1012A0</td> <td>CIRCULAR ELEMENT 1365W 120V</td> <td>1</td> <td>PZ</td> </tr> <tr> <td>VI1220A1</td> <td>4,2X12 TCB SELF-TAPPIN G SCREW</td> <td>5</td> <td>PZ</td> </tr> <tr> <td>VM1794A0</td> <td>250X4.8 PA66 BLACK CLAMP</td> <td>2</td> <td>PZ</td> </tr> <tr> <td>VM2103A0</td> <td>CLAMP LOCK</td> <td>2</td> <td>PZ</td> </tr> </tbody> </table>	Code	Description	Qty	UOM	GN1326A1	ELEMENT SEALING	1	PZ	RS1012A0	CIRCULAR ELEMENT 1365W 120V	1	PZ	VI1220A1	4,2X12 TCB SELF-TAPPIN G SCREW	5	PZ	VM1794A0	250X4.8 PA66 BLACK CLAMP	2	PZ	VM2103A0	CLAMP LOCK	2	PZ				
					Code	Description	Qty	UOM																									
					GN1326A1	ELEMENT SEALING	1	PZ																									
					RS1012A0	CIRCULAR ELEMENT 1365W 120V	1	PZ																									
					VI1220A1	4,2X12 TCB SELF-TAPPIN G SCREW	5	PZ																									
					VM1794A0	250X4.8 PA66 BLACK CLAMP	2	PZ																									
			VM2103A0	CLAMP LOCK	2	PZ																											
			KRS1011A	ROBERTA/LISA HEATING ELEMENT KIT	<table border="1"> <thead> <tr> <th>Code</th> <th>Description</th> <th>Qty</th> <th>UOM</th> </tr> </thead> <tbody> <tr> <td>GN1326A1</td> <td>ELEMENT SEALING</td> <td>1</td> <td>PZ</td> </tr> <tr> <td>RS1011A0</td> <td>2560W 220-230V HEATING ELEMENT</td> <td>1</td> <td>PZ</td> </tr> <tr> <td>SL1045A0</td> <td>S53 BLACK SILICONE - 80ML CARTRIDGE</td> <td>1</td> <td>PZ</td> </tr> <tr> <td>VI1220A1</td> <td>4,2X12 TCB SELF-TAPPIN G SCREW</td> <td>5</td> <td>PZ</td> </tr> <tr> <td>VM1794A0</td> <td>250X4.8 PA66 BLACK CLAMP</td> <td>2</td> <td>PZ</td> </tr> <tr> <td>VM2103A0</td> <td>CLAMP LOCK</td> <td>2</td> <td>PZ</td> </tr> </tbody> </table>	Code	Description	Qty	UOM	GN1326A1	ELEMENT SEALING	1	PZ	RS1011A0	2560W 220-230V HEATING ELEMENT	1	PZ	SL1045A0	S53 BLACK SILICONE - 80ML CARTRIDGE	1	PZ	VI1220A1	4,2X12 TCB SELF-TAPPIN G SCREW	5	PZ	VM1794A0	250X4.8 PA66 BLACK CLAMP	2	PZ	VM2103A0	CLAMP LOCK	2	PZ
					Code	Description	Qty	UOM																									
					GN1326A1	ELEMENT SEALING	1	PZ																									
					RS1011A0	2560W 220-230V HEATING ELEMENT	1	PZ																									
					SL1045A0	S53 BLACK SILICONE - 80ML CARTRIDGE	1	PZ																									
VI1220A1	4,2X12 TCB SELF-TAPPIN G SCREW	5			PZ																												
VM1794A0	250X4.8 PA66 BLACK CLAMP	2	PZ																														
VM2103A0	CLAMP LOCK	2	PZ																														
KRS0090A	HEATING ELEMENT 1.26KW	<table border="1"> <thead> <tr> <th>Code</th> <th>Description</th> <th>Qty</th> <th>UOM</th> </tr> </thead> <tbody> <tr> <td>GN1326A1</td> <td>ELEMENT SEALING</td> <td>1</td> <td>PZ</td> </tr> <tr> <td>RS0090A0</td> <td>CIRC. HEAT. ELEMENT 1260W 220-230</td> <td>1</td> <td>PZ</td> </tr> <tr> <td>VI1220A1</td> <td>4,2X12 TCB SELF-TAPPIN G SCREW</td> <td>3</td> <td>PZ</td> </tr> <tr> <td>VM1794A0</td> <td>250X4.8 PA66 BLACK CLAMP</td> <td>2</td> <td>PZ</td> </tr> <tr> <td>VM2103A0</td> <td>CLAMP LOCK</td> <td>2</td> <td>PZ</td> </tr> </tbody> </table>	Code	Description	Qty	UOM	GN1326A1	ELEMENT SEALING	1	PZ	RS0090A0	CIRC. HEAT. ELEMENT 1260W 220-230	1	PZ	VI1220A1	4,2X12 TCB SELF-TAPPIN G SCREW	3	PZ	VM1794A0	250X4.8 PA66 BLACK CLAMP	2	PZ	VM2103A0	CLAMP LOCK	2	PZ							
		Code	Description	Qty	UOM																												
		GN1326A1	ELEMENT SEALING	1	PZ																												
		RS0090A0	CIRC. HEAT. ELEMENT 1260W 220-230	1	PZ																												
		VI1220A1	4,2X12 TCB SELF-TAPPIN G SCREW	3	PZ																												
		VM1794A0	250X4.8 PA66 BLACK CLAMP	2	PZ																												
VM2103A0	CLAMP LOCK	2	PZ																														
KRS0050A	HEATING ELEMENT KIT 0.5KW	<table border="1"> <thead> <tr> <th>Code</th> <th>Description</th> <th>Qty</th> <th>UOM</th> </tr> </thead> <tbody> <tr> <td>GN1326A1</td> <td>ELEMENT SEALING</td> <td>1</td> <td>PZ</td> </tr> <tr> <td>IP1075A1</td> <td></td> <td>1</td> <td>PZ</td> </tr> <tr> <td>IP1080A1</td> <td></td> <td>1</td> <td>PZ</td> </tr> <tr> <td>RS0050A0</td> <td>HEAT. ELEMENT 500W 220-230V LIEV</td> <td>1</td> <td>PZ</td> </tr> <tr> <td>VI1220A1</td> <td>4,2X12 TCB SELF-TAPPIN G SCREW</td> <td>2</td> <td>PZ</td> </tr> </tbody> </table>	Code	Description	Qty	UOM	GN1326A1	ELEMENT SEALING	1	PZ	IP1075A1		1	PZ	IP1080A1		1	PZ	RS0050A0	HEAT. ELEMENT 500W 220-230V LIEV	1	PZ	VI1220A1	4,2X12 TCB SELF-TAPPIN G SCREW	2	PZ							
		Code	Description	Qty	UOM																												
		GN1326A1	ELEMENT SEALING	1	PZ																												
		IP1075A1		1	PZ																												
		IP1080A1		1	PZ																												
RS0050A0	HEAT. ELEMENT 500W 220-230V LIEV	1	PZ																														
VI1220A1	4,2X12 TCB SELF-TAPPIN G SCREW	2	PZ																														





COMPONENT			SPARE PART																										
Code	Description	Image	Code	Description	Components list																								
GN1326A	ELEMENT SEALING		KRS0011A	HEATING ELEMENT 1.465KW RS0011A	<table border="1"> <thead> <tr> <th>Code</th> <th>Description</th> <th>Qty</th> <th>UOM</th> </tr> </thead> <tbody> <tr> <td>GN1326A1</td> <td>ELEMENT SEALING</td> <td>1</td> <td>PZ</td> </tr> <tr> <td>RS0011A0</td> <td>CIRC.HEAT. ELEMENT 1465W 220-230</td> <td>1</td> <td>PZ</td> </tr> <tr> <td>VI1220A1</td> <td>4,2X12 TCB SELF-TAPPIN G SCREW</td> <td>3</td> <td>PZ</td> </tr> <tr> <td>VM1794A0</td> <td>250X4.8 PA66 BLACK CLAMP</td> <td>2</td> <td>PZ</td> </tr> <tr> <td>VM2103A0</td> <td>CLAMP LOCK</td> <td>2</td> <td>PZ</td> </tr> </tbody> </table>	Code	Description	Qty	UOM	GN1326A1	ELEMENT SEALING	1	PZ	RS0011A0	CIRC.HEAT. ELEMENT 1465W 220-230	1	PZ	VI1220A1	4,2X12 TCB SELF-TAPPIN G SCREW	3	PZ	VM1794A0	250X4.8 PA66 BLACK CLAMP	2	PZ	VM2103A0	CLAMP LOCK	2	PZ
			Code	Description	Qty	UOM																							
			GN1326A1	ELEMENT SEALING	1	PZ																							
RS0011A0	CIRC.HEAT. ELEMENT 1465W 220-230	1	PZ																										
VI1220A1	4,2X12 TCB SELF-TAPPIN G SCREW	3	PZ																										
VM1794A0	250X4.8 PA66 BLACK CLAMP	2	PZ																										
VM2103A0	CLAMP LOCK	2	PZ																										
KRS0010A	KIT HEATING ELEMENT RS10010A	<table border="1"> <thead> <tr> <th>Code</th> <th>Description</th> <th>Qty</th> <th>UOM</th> </tr> </thead> <tbody> <tr> <td>GN1326A1</td> <td>ELEMENT SEALING</td> <td>1</td> <td>PZ</td> </tr> <tr> <td>IP1075A1</td> <td></td> <td>1</td> <td>PZ</td> </tr> <tr> <td>IP1080A1</td> <td></td> <td>5</td> <td>PZ</td> </tr> <tr> <td>RS0010A0</td> <td>CIRC.HEAT. ELEMENT 2560W - 220-230 V</td> <td>1</td> <td>PZ</td> </tr> <tr> <td>VI1220A1</td> <td>4,2X12 TCB SELF-TAPPIN G SCREW</td> <td>3</td> <td>PZ</td> </tr> </tbody> </table>	Code	Description	Qty	UOM	GN1326A1	ELEMENT SEALING	1	PZ	IP1075A1		1	PZ	IP1080A1		5	PZ	RS0010A0	CIRC.HEAT. ELEMENT 2560W - 220-230 V	1	PZ	VI1220A1	4,2X12 TCB SELF-TAPPIN G SCREW	3	PZ			
Code	Description	Qty	UOM																										
GN1326A1	ELEMENT SEALING	1	PZ																										
IP1075A1		1	PZ																										
IP1080A1		5	PZ																										
RS0010A0	CIRC.HEAT. ELEMENT 2560W - 220-230 V	1	PZ																										
VI1220A1	4,2X12 TCB SELF-TAPPIN G SCREW	3	PZ																										
KG1326A	HEATING ELEMENT GASKET 5 PCS KIT	<table border="1"> <thead> <tr> <th>Code</th> <th>Description</th> <th>Qty</th> <th>UOM</th> </tr> </thead> <tbody> <tr> <td>GN1326A1</td> <td>ELEMENT SEALING</td> <td>5</td> <td>PZ</td> </tr> </tbody> </table>	Code	Description	Qty	UOM	GN1326A1	ELEMENT SEALING	5	PZ																			
Code	Description	Qty	UOM																										
GN1326A1	ELEMENT SEALING	5	PZ																										
RS1274A	100W 60V 1 TURN FLAT ELEMENT		KRS1274A	100W MOTOR BRAKING ELEMENT KIT	<table border="1"> <thead> <tr> <th>Code</th> <th>Description</th> <th>Qty</th> <th>UOM</th> </tr> </thead> <tbody> <tr> <td>GN1326A1</td> <td>ELEMENT SEALING</td> <td>1</td> <td>PZ</td> </tr> <tr> <td>RS1274A0</td> <td>100W 60V 1 TURN FLAT ELEMENT</td> <td>1</td> <td>PZ</td> </tr> <tr> <td>SL1045A0</td> <td>S53 BLACK SILICONE - 80ML CARTRIDGE</td> <td>1</td> <td>PZ</td> </tr> <tr> <td>VI1220A1</td> <td>4,2X12 TCB SELF-TAPPIN G SCREW</td> <td>2</td> <td>PZ</td> </tr> </tbody> </table>	Code	Description	Qty	UOM	GN1326A1	ELEMENT SEALING	1	PZ	RS1274A0	100W 60V 1 TURN FLAT ELEMENT	1	PZ	SL1045A0	S53 BLACK SILICONE - 80ML CARTRIDGE	1	PZ	VI1220A1	4,2X12 TCB SELF-TAPPIN G SCREW	2	PZ				
Code	Description	Qty	UOM																										
GN1326A1	ELEMENT SEALING	1	PZ																										
RS1274A0	100W 60V 1 TURN FLAT ELEMENT	1	PZ																										
SL1045A0	S53 BLACK SILICONE - 80ML CARTRIDGE	1	PZ																										
VI1220A1	4,2X12 TCB SELF-TAPPIN G SCREW	2	PZ																										
GN1285A	NTC TEMPERATURE PROBE SEALING		KTR1106A	5-5E S. L2000 CHAMBER TEMP. PROBE KIT	<table border="1"> <thead> <tr> <th>Code</th> <th>Description</th> <th>Qty</th> <th>UOM</th> </tr> </thead> <tbody> <tr> <td>GN1285A0</td> <td>NTC TEMPERATUR E PROBE SEALING</td> <td>1</td> <td>PZ</td> </tr> <tr> <td>SL1045A0</td> <td>S53 BLACK SILICONE - 80ML CARTRIDGE</td> <td>1</td> <td>PZ</td> </tr> </tbody> </table>	Code	Description	Qty	UOM	GN1285A0	NTC TEMPERATUR E PROBE SEALING	1	PZ	SL1045A0	S53 BLACK SILICONE - 80ML CARTRIDGE	1	PZ												
Code	Description	Qty	UOM																										
GN1285A0	NTC TEMPERATUR E PROBE SEALING	1	PZ																										
SL1045A0	S53 BLACK SILICONE - 80ML CARTRIDGE	1	PZ																										



COMPONENT			SPARE PART																															
Code	Description	Image	Code	Description	Components list																													
GN1285A	NTC TEMPERATURE PROBE SEALING		KTR1106A	5-5E S. L2000 CHAMBER TEMP. PROBE KIT	<table border="1"> <thead> <tr> <th>Code</th> <th>Description</th> <th>Qty</th> <th>UOM</th> </tr> </thead> <tbody> <tr> <td>TR1106A3</td> <td>PT100 L=2000 TEMPERATUR E PROBE</td> <td>1</td> <td>PZ</td> </tr> <tr> <td>VI1220A1</td> <td>4,2X12 TCB SELF-TAPPIN G SCREW</td> <td>2</td> <td>PZ</td> </tr> <tr> <td>VM1465A0</td> <td>CHEFTOP TEMPERATUR E PROBE COVER</td> <td>1</td> <td>PZ</td> </tr> </tbody> </table>	Code	Description	Qty	UOM	TR1106A3	PT100 L=2000 TEMPERATUR E PROBE	1	PZ	VI1220A1	4,2X12 TCB SELF-TAPPIN G SCREW	2	PZ	VM1465A0	CHEFTOP TEMPERATUR E PROBE COVER	1	PZ													
			Code	Description	Qty	UOM																												
			TR1106A3	PT100 L=2000 TEMPERATUR E PROBE	1	PZ																												
VI1220A1	4,2X12 TCB SELF-TAPPIN G SCREW	2	PZ																															
VM1465A0	CHEFTOP TEMPERATUR E PROBE COVER	1	PZ																															
KTR1105A	PT100 L1000 TEMPERATURE PROBE KIT	<table border="1"> <thead> <tr> <th>Code</th> <th>Description</th> <th>Qty</th> <th>UOM</th> </tr> </thead> <tbody> <tr> <td>GN1120A0</td> <td>TEMPERATUR E PROBE NTC SEAL</td> <td>1</td> <td>PZ</td> </tr> <tr> <td>GN1285A0</td> <td>NTC TEMPERATUR E PROBE SEALING</td> <td>1</td> <td>PZ</td> </tr> <tr> <td>SL1045A0</td> <td>S53 BLACK SILICONE - 80ML CARTRIDGE</td> <td>1</td> <td>PZ</td> </tr> <tr> <td>TR1105A3</td> <td>L=1000 PT1000 TEMPERATUR E PROBE</td> <td>1</td> <td>PZ</td> </tr> <tr> <td>TR1105A4</td> <td></td> <td>1</td> <td>PZ</td> </tr> <tr> <td>VI1220A1</td> <td>4,2X12 TCB SELF-TAPPIN G SCREW</td> <td>2</td> <td>PZ</td> </tr> <tr> <td>VM1465A0</td> <td>CHEFTOP TEMPERATUR E PROBE COVER</td> <td>1</td> <td>PZ</td> </tr> </tbody> </table>	Code	Description	Qty	UOM	GN1120A0	TEMPERATUR E PROBE NTC SEAL	1	PZ	GN1285A0	NTC TEMPERATUR E PROBE SEALING	1	PZ	SL1045A0	S53 BLACK SILICONE - 80ML CARTRIDGE	1	PZ	TR1105A3	L=1000 PT1000 TEMPERATUR E PROBE	1	PZ	TR1105A4		1	PZ	VI1220A1	4,2X12 TCB SELF-TAPPIN G SCREW	2	PZ	VM1465A0	CHEFTOP TEMPERATUR E PROBE COVER	1	PZ
Code	Description	Qty	UOM																															
GN1120A0	TEMPERATUR E PROBE NTC SEAL	1	PZ																															
GN1285A0	NTC TEMPERATUR E PROBE SEALING	1	PZ																															
SL1045A0	S53 BLACK SILICONE - 80ML CARTRIDGE	1	PZ																															
TR1105A3	L=1000 PT1000 TEMPERATUR E PROBE	1	PZ																															
TR1105A4		1	PZ																															
VI1220A1	4,2X12 TCB SELF-TAPPIN G SCREW	2	PZ																															
VM1465A0	CHEFTOP TEMPERATUR E PROBE COVER	1	PZ																															
KTR1096A	NTC 150 L=1500 TEMPERATURE PROBE KIT	<table border="1"> <thead> <tr> <th>Code</th> <th>Description</th> <th>Qty</th> <th>UOM</th> </tr> </thead> <tbody> <tr> <td>GN1120A0</td> <td>TEMPERATUR E PROBE NTC SEAL</td> <td>1</td> <td>PZ</td> </tr> <tr> <td>GN1285A0</td> <td>NTC TEMPERATUR E PROBE SEALING</td> <td>2</td> <td>PZ</td> </tr> <tr> <td>SL1045A0</td> <td>S53 BLACK SILICONE - 80ML CARTRIDGE</td> <td>1</td> <td>PZ</td> </tr> <tr> <td>TR1096A0</td> <td>TEMPERATUR E PROBE NTC 150 L=1500</td> <td>1</td> <td>PZ</td> </tr> <tr> <td>VI1220A1</td> <td>4,2X12 TCB SELF-TAPPIN G SCREW</td> <td>2</td> <td>PZ</td> </tr> <tr> <td>VM1465A0</td> <td>CHEFTOP TEMPERATUR E PROBE COVER</td> <td>1</td> <td>PZ</td> </tr> </tbody> </table>	Code	Description	Qty	UOM	GN1120A0	TEMPERATUR E PROBE NTC SEAL	1	PZ	GN1285A0	NTC TEMPERATUR E PROBE SEALING	2	PZ	SL1045A0	S53 BLACK SILICONE - 80ML CARTRIDGE	1	PZ	TR1096A0	TEMPERATUR E PROBE NTC 150 L=1500	1	PZ	VI1220A1	4,2X12 TCB SELF-TAPPIN G SCREW	2	PZ	VM1465A0	CHEFTOP TEMPERATUR E PROBE COVER	1	PZ				
Code	Description	Qty	UOM																															
GN1120A0	TEMPERATUR E PROBE NTC SEAL	1	PZ																															
GN1285A0	NTC TEMPERATUR E PROBE SEALING	2	PZ																															
SL1045A0	S53 BLACK SILICONE - 80ML CARTRIDGE	1	PZ																															
TR1096A0	TEMPERATUR E PROBE NTC 150 L=1500	1	PZ																															
VI1220A1	4,2X12 TCB SELF-TAPPIN G SCREW	2	PZ																															
VM1465A0	CHEFTOP TEMPERATUR E PROBE COVER	1	PZ																															

COMPONENT			SPARE PART																														
Code	Description	Image	Code	Description	Components list																												
GN1285A	NTC TEMPERATURE PROBE SEALING		KTR1095A	NTC 150 L=1050 TEMPERATURE PROBE KIT	<table border="1"> <thead> <tr> <th>Code</th> <th>Description</th> <th>Qty</th> <th>UOM</th> </tr> </thead> <tbody> <tr> <td>GN1120A0</td> <td>TEMPERATUR E PROBE NTC SEAL</td> <td>1</td> <td>PZ</td> </tr> <tr> <td>GN1285A0</td> <td>NTC TEMPERATUR E PROBE SEALING</td> <td>1</td> <td>PZ</td> </tr> <tr> <td>SL1045A0</td> <td>S53 BLACK SILICONE - 80ML CARTRIDGE</td> <td>1</td> <td>PZ</td> </tr> <tr> <td>TR1095A0</td> <td>TEMPERATUR E PROBE NTC 150 L=1050</td> <td>1</td> <td>PZ</td> </tr> <tr> <td>VI1220A1</td> <td>4,2X12 TCB SELF-TAPPIN G SCREW</td> <td>2</td> <td>PZ</td> </tr> <tr> <td>VM1465A0</td> <td>CHEFTOP TEMPERATUR E PROBE COVER</td> <td>1</td> <td>PZ</td> </tr> </tbody> </table>	Code	Description	Qty	UOM	GN1120A0	TEMPERATUR E PROBE NTC SEAL	1	PZ	GN1285A0	NTC TEMPERATUR E PROBE SEALING	1	PZ	SL1045A0	S53 BLACK SILICONE - 80ML CARTRIDGE	1	PZ	TR1095A0	TEMPERATUR E PROBE NTC 150 L=1050	1	PZ	VI1220A1	4,2X12 TCB SELF-TAPPIN G SCREW	2	PZ	VM1465A0	CHEFTOP TEMPERATUR E PROBE COVER	1	PZ
			Code	Description	Qty	UOM																											
GN1120A0	TEMPERATUR E PROBE NTC SEAL	1	PZ																														
GN1285A0	NTC TEMPERATUR E PROBE SEALING	1	PZ																														
SL1045A0	S53 BLACK SILICONE - 80ML CARTRIDGE	1	PZ																														
TR1095A0	TEMPERATUR E PROBE NTC 150 L=1050	1	PZ																														
VI1220A1	4,2X12 TCB SELF-TAPPIN G SCREW	2	PZ																														
VM1465A0	CHEFTOP TEMPERATUR E PROBE COVER	1	PZ																														
KTR1002A	PT100 L1000 UL TEMPERATURE PROBE KIT	<table border="1"> <thead> <tr> <th>Code</th> <th>Description</th> <th>Qty</th> <th>UOM</th> </tr> </thead> <tbody> <tr> <td>GN1285A0</td> <td>NTC TEMPERATUR E PROBE SEALING</td> <td>2</td> <td>PZ</td> </tr> <tr> <td>SL1045A0</td> <td>S53 BLACK SILICONE - 80ML CARTRIDGE</td> <td>1</td> <td>PZ</td> </tr> <tr> <td>TR1002A0</td> <td>TEMPERATUR E PROBE UL PT100 L1000</td> <td>1</td> <td>PZ</td> </tr> <tr> <td>VI1220A1</td> <td>4,2X12 TCB SELF-TAPPIN G SCREW</td> <td>2</td> <td>PZ</td> </tr> <tr> <td>VM1465A0</td> <td>CHEFTOP TEMPERATUR E PROBE COVER</td> <td>1</td> <td>PZ</td> </tr> </tbody> </table>	Code	Description	Qty	UOM	GN1285A0	NTC TEMPERATUR E PROBE SEALING	2	PZ	SL1045A0	S53 BLACK SILICONE - 80ML CARTRIDGE	1	PZ	TR1002A0	TEMPERATUR E PROBE UL PT100 L1000	1	PZ	VI1220A1	4,2X12 TCB SELF-TAPPIN G SCREW	2	PZ	VM1465A0	CHEFTOP TEMPERATUR E PROBE COVER	1	PZ							
Code	Description	Qty	UOM																														
GN1285A0	NTC TEMPERATUR E PROBE SEALING	2	PZ																														
SL1045A0	S53 BLACK SILICONE - 80ML CARTRIDGE	1	PZ																														
TR1002A0	TEMPERATUR E PROBE UL PT100 L1000	1	PZ																														
VI1220A1	4,2X12 TCB SELF-TAPPIN G SCREW	2	PZ																														
VM1465A0	CHEFTOP TEMPERATUR E PROBE COVER	1	PZ																														
TR1106A	PT100 L=2000 TEMPERATURE PROBE		KTR1106B	MIND.MAPS L2000 CHAMBER TEMP. PROBE KIT	<table border="1"> <thead> <tr> <th>Code</th> <th>Description</th> <th>Qty</th> <th>UOM</th> </tr> </thead> <tbody> <tr> <td>GN1285A0</td> <td>NTC TEMPERATUR E PROBE SEALING</td> <td>1</td> <td>PZ</td> </tr> <tr> <td>SL1045A0</td> <td>S53 BLACK SILICONE - 80ML CARTRIDGE</td> <td>1</td> <td>PZ</td> </tr> <tr> <td>TR1106B0</td> <td></td> <td>1</td> <td>PZ</td> </tr> <tr> <td>VI1220A1</td> <td>4,2X12 TCB SELF-TAPPIN G SCREW</td> <td>2</td> <td>PZ</td> </tr> </tbody> </table>	Code	Description	Qty	UOM	GN1285A0	NTC TEMPERATUR E PROBE SEALING	1	PZ	SL1045A0	S53 BLACK SILICONE - 80ML CARTRIDGE	1	PZ	TR1106B0		1	PZ	VI1220A1	4,2X12 TCB SELF-TAPPIN G SCREW	2	PZ								
Code	Description	Qty	UOM																														
GN1285A0	NTC TEMPERATUR E PROBE SEALING	1	PZ																														
SL1045A0	S53 BLACK SILICONE - 80ML CARTRIDGE	1	PZ																														
TR1106B0		1	PZ																														
VI1220A1	4,2X12 TCB SELF-TAPPIN G SCREW	2	PZ																														





COMPONENT			SPARE PART																							
Code	Description	Image	Code	Description	Components list																					
TR1106A	PT100 L=2000 TEMPERATURE PROBE		KTR1106B	MIND.MAPS L2000 CHAMBER TEMP. PROBE KIT	<table border="1"> <thead> <tr> <th>Code</th> <th>Description</th> <th>Qty</th> <th>UOM</th> </tr> </thead> <tbody> <tr> <td>VM1464A0</td> <td>CT BT TEMPERATUR E PROBE COVER</td> <td>1</td> <td>PZ</td> </tr> <tr> <td>VM1465A0</td> <td>CHEFTOP TEMPERATUR E PROBE COVER</td> <td>1</td> <td>PZ</td> </tr> </tbody> </table>	Code	Description	Qty	UOM	VM1464A0	CT BT TEMPERATUR E PROBE COVER	1	PZ	VM1465A0	CHEFTOP TEMPERATUR E PROBE COVER	1	PZ									
			Code	Description	Qty	UOM																				
VM1464A0	CT BT TEMPERATUR E PROBE COVER	1	PZ																							
VM1465A0	CHEFTOP TEMPERATUR E PROBE COVER	1	PZ																							
KTR1106A	5-5E S. L2000 CHAMBER TEMP. PROBE KIT	<table border="1"> <thead> <tr> <th>Code</th> <th>Description</th> <th>Qty</th> <th>UOM</th> </tr> </thead> <tbody> <tr> <td>GN1285A0</td> <td>NTC TEMPERATUR E PROBE SEALING</td> <td>1</td> <td>PZ</td> </tr> <tr> <td>SL1045A0</td> <td>S53 BLACK SILICONE - 80ML CARTRIDGE</td> <td>1</td> <td>PZ</td> </tr> <tr> <td>TR1106A3</td> <td>PT100 L=2000 TEMPERATUR E PROBE</td> <td>1</td> <td>PZ</td> </tr> <tr> <td>VI1220A1</td> <td>4,2X12 TCB SELF-TAPPIN G SCREW</td> <td>2</td> <td>PZ</td> </tr> <tr> <td>VM1465A0</td> <td>CHEFTOP TEMPERATUR E PROBE COVER</td> <td>1</td> <td>PZ</td> </tr> </tbody> </table>	Code	Description	Qty	UOM	GN1285A0	NTC TEMPERATUR E PROBE SEALING	1	PZ	SL1045A0	S53 BLACK SILICONE - 80ML CARTRIDGE	1	PZ	TR1106A3	PT100 L=2000 TEMPERATUR E PROBE	1	PZ	VI1220A1	4,2X12 TCB SELF-TAPPIN G SCREW	2	PZ	VM1465A0	CHEFTOP TEMPERATUR E PROBE COVER	1	PZ
Code	Description	Qty	UOM																							
GN1285A0	NTC TEMPERATUR E PROBE SEALING	1	PZ																							
SL1045A0	S53 BLACK SILICONE - 80ML CARTRIDGE	1	PZ																							
TR1106A3	PT100 L=2000 TEMPERATUR E PROBE	1	PZ																							
VI1220A1	4,2X12 TCB SELF-TAPPIN G SCREW	2	PZ																							
VM1465A0	CHEFTOP TEMPERATUR E PROBE COVER	1	PZ																							
VM1464A	CT BT TEMPERATURE PROBE COVER		KVM1464A	CT BT TEMPERATURE PROBE COVER KIT	<table border="1"> <thead> <tr> <th>Code</th> <th>Description</th> <th>Qty</th> <th>UOM</th> </tr> </thead> <tbody> <tr> <td>VM1464A0</td> <td>CT BT TEMPERATUR E PROBE COVER</td> <td>1</td> <td>PZ</td> </tr> </tbody> </table>	Code	Description	Qty	UOM	VM1464A0	CT BT TEMPERATUR E PROBE COVER	1	PZ													
Code	Description	Qty	UOM																							
VM1464A0	CT BT TEMPERATUR E PROBE COVER	1	PZ																							
TR1003A	PT100 L2000 TEMPERATURE PROBE-US VERSION		KTR1003B	US MM L2000 CHAMBER TEMP. PROBE KIT	<table border="1"> <thead> <tr> <th>Code</th> <th>Description</th> <th>Qty</th> <th>UOM</th> </tr> </thead> <tbody> <tr> <td>GN1285A0</td> <td>NTC TEMPERATUR E PROBE SEALING</td> <td>1</td> <td>PZ</td> </tr> <tr> <td>SL1045A0</td> <td>S53 BLACK SILICONE - 80ML CARTRIDGE</td> <td>1</td> <td>PZ</td> </tr> <tr> <td>TR1003B0</td> <td></td> <td>1</td> <td>PZ</td> </tr> <tr> <td>VI1220A1</td> <td>4,2X12 TCB SELF-TAPPIN G SCREW</td> <td>2</td> <td>PZ</td> </tr> </tbody> </table>	Code	Description	Qty	UOM	GN1285A0	NTC TEMPERATUR E PROBE SEALING	1	PZ	SL1045A0	S53 BLACK SILICONE - 80ML CARTRIDGE	1	PZ	TR1003B0		1	PZ	VI1220A1	4,2X12 TCB SELF-TAPPIN G SCREW	2	PZ	
			Code	Description	Qty	UOM																				
GN1285A0	NTC TEMPERATUR E PROBE SEALING	1	PZ																							
SL1045A0	S53 BLACK SILICONE - 80ML CARTRIDGE	1	PZ																							
TR1003B0		1	PZ																							
VI1220A1	4,2X12 TCB SELF-TAPPIN G SCREW	2	PZ																							

COMPONENT			SPARE PART																										
Code	Description	Image	Code	Description	Components list																								
TR1003A	PT100 L2000 TEMPERATURE PROBE-US VERSION		KTR1003B	US MM L2000 CHAMBER TEMP. PROBE KIT	<table border="1"> <thead> <tr> <th>Code</th> <th>Description</th> <th>Qty</th> <th>UOM</th> </tr> </thead> <tbody> <tr> <td>VM1464A0</td> <td>CT BT TEMPERATUR E PROBE COVER</td> <td>1</td> <td>PZ</td> </tr> <tr> <td>VM1465A0</td> <td>CHEFTOP TEMPERATUR E PROBE COVER</td> <td>1</td> <td>PZ</td> </tr> </tbody> </table>	Code	Description	Qty	UOM	VM1464A0	CT BT TEMPERATUR E PROBE COVER	1	PZ	VM1465A0	CHEFTOP TEMPERATUR E PROBE COVER	1	PZ												
			Code	Description	Qty	UOM																							
VM1464A0	CT BT TEMPERATUR E PROBE COVER	1	PZ																										
VM1465A0	CHEFTOP TEMPERATUR E PROBE COVER	1	PZ																										
KTR1003A	5-5E S.CHEFTOP US TEMPERATURE PROBE KIT	<table border="1"> <thead> <tr> <th>Code</th> <th>Description</th> <th>Qty</th> <th>UOM</th> </tr> </thead> <tbody> <tr> <td>GN1285A0</td> <td>NTC TEMPERATUR E PROBE SEALING</td> <td>1</td> <td>PZ</td> </tr> <tr> <td>SL1045A0</td> <td>S53 BLACK SILICONE - 80ML CARTRIDGE</td> <td>1</td> <td>PZ</td> </tr> <tr> <td>TR1003A0</td> <td>PT100 L2000 TEMPERATUR E PROBE-US VERSION</td> <td>1</td> <td>PZ</td> </tr> <tr> <td>VI1220A1</td> <td>4,2X12 TCB SELF-TAPPIN G SCREW</td> <td>2</td> <td>PZ</td> </tr> <tr> <td>VM1465A0</td> <td>CHEFTOP TEMPERATUR E PROBE COVER</td> <td>1</td> <td>PZ</td> </tr> </tbody> </table>	Code	Description	Qty	UOM	GN1285A0	NTC TEMPERATUR E PROBE SEALING	1	PZ	SL1045A0	S53 BLACK SILICONE - 80ML CARTRIDGE	1	PZ	TR1003A0	PT100 L2000 TEMPERATUR E PROBE-US VERSION	1	PZ	VI1220A1	4,2X12 TCB SELF-TAPPIN G SCREW	2	PZ	VM1465A0	CHEFTOP TEMPERATUR E PROBE COVER	1	PZ			
Code	Description	Qty	UOM																										
GN1285A0	NTC TEMPERATUR E PROBE SEALING	1	PZ																										
SL1045A0	S53 BLACK SILICONE - 80ML CARTRIDGE	1	PZ																										
TR1003A0	PT100 L2000 TEMPERATUR E PROBE-US VERSION	1	PZ																										
VI1220A1	4,2X12 TCB SELF-TAPPIN G SCREW	2	PZ																										
VM1465A0	CHEFTOP TEMPERATUR E PROBE COVER	1	PZ																										
GN1531A	THERMOSTAT BULB INLET SEALING		KTR1136A	330°C SAFETY THERMOSTAT KIT	<table border="1"> <thead> <tr> <th>Code</th> <th>Description</th> <th>Qty</th> <th>UOM</th> </tr> </thead> <tbody> <tr> <td>0H7030A0</td> <td>THERMOSTAT BULB INLET COVER</td> <td>1</td> <td>PZ</td> </tr> <tr> <td>GN1531A0</td> <td>THERMOSTAT BULB INLET SEALING</td> <td>1</td> <td>PZ</td> </tr> <tr> <td>SL1045A0</td> <td>S53 BLACK SILICONE - 80ML CARTRIDGE</td> <td>1</td> <td>PZ</td> </tr> <tr> <td>TR1136A0</td> <td>330°C 1 POLE SAFETY THERMOSTAT</td> <td>1</td> <td>PZ</td> </tr> <tr> <td>VI1220A1</td> <td>4,2X12 TCB SELF-TAPPIN G SCREW</td> <td>3</td> <td>PZ</td> </tr> </tbody> </table>	Code	Description	Qty	UOM	0H7030A0	THERMOSTAT BULB INLET COVER	1	PZ	GN1531A0	THERMOSTAT BULB INLET SEALING	1	PZ	SL1045A0	S53 BLACK SILICONE - 80ML CARTRIDGE	1	PZ	TR1136A0	330°C 1 POLE SAFETY THERMOSTAT	1	PZ	VI1220A1	4,2X12 TCB SELF-TAPPIN G SCREW	3	PZ
Code	Description	Qty	UOM																										
0H7030A0	THERMOSTAT BULB INLET COVER	1	PZ																										
GN1531A0	THERMOSTAT BULB INLET SEALING	1	PZ																										
SL1045A0	S53 BLACK SILICONE - 80ML CARTRIDGE	1	PZ																										
TR1136A0	330°C 1 POLE SAFETY THERMOSTAT	1	PZ																										
VI1220A1	4,2X12 TCB SELF-TAPPIN G SCREW	3	PZ																										

COMPONENT			SPARE PART																																										
Code	Description	Image	Code	Description	Components list																																								
0H7030A	THERMOSTAT BULB INLET COVER		K0H7030A	THERMOSTAT BULB INLET COVER KIT	<table border="1"> <thead> <tr> <th>Code</th> <th>Description</th> <th>Qty</th> <th>UOM</th> </tr> </thead> <tbody> <tr> <td>0H7030A0</td> <td>THERMOSTAT BULB INLET COVER</td> <td>1</td> <td>PZ</td> </tr> </tbody> </table>	Code	Description	Qty	UOM	0H7030A0	THERMOSTAT BULB INLET COVER	1	PZ																																
Code	Description	Qty	UOM																																										
0H7030A0	THERMOSTAT BULB INLET COVER	1	PZ																																										
VL1037A	WASHING SYSTEM ROTOR		KVL1037A	WASHING SYSTEM ROTOR KIT	<table border="1"> <thead> <tr> <th>Code</th> <th>Description</th> <th>Qty</th> <th>UOM</th> </tr> </thead> <tbody> <tr> <td>GN1416B0</td> <td>WASHING SYSTEM ROTOR BEARING</td> <td>1</td> <td>PZ</td> </tr> <tr> <td>TF1065B0</td> <td>WASHING SYSTEM ROTOR PIVOT</td> <td>1</td> <td>PZ</td> </tr> <tr> <td>TF1066A1</td> <td>WASHING SYSTEM ROTOR BUSH</td> <td>1</td> <td>PZ</td> </tr> <tr> <td>UG1005B1</td> <td>LONG RAY ROTOR WATER NOZZL</td> <td>1</td> <td>PZ</td> </tr> <tr> <td>UG1006B3</td> <td>LONG RAY ROTOR WATER NOZZL</td> <td>1</td> <td>PZ</td> </tr> <tr> <td>VI1220A1</td> <td>4,2X12 TCB SELF-TAPPIN G SCREW</td> <td>6</td> <td>PZ</td> </tr> <tr> <td>VM1955C0</td> <td>WASHING SYSTEM ROTOR</td> <td>1</td> <td>PZ</td> </tr> <tr> <td>VM1985C1</td> <td>WASHING SYSTEM ROTOR COVE</td> <td>1</td> <td>PZ</td> </tr> <tr> <td>VM1986A0</td> <td>NOZZLE COVE</td> <td>1</td> <td>PZ</td> </tr> </tbody> </table>	Code	Description	Qty	UOM	GN1416B0	WASHING SYSTEM ROTOR BEARING	1	PZ	TF1065B0	WASHING SYSTEM ROTOR PIVOT	1	PZ	TF1066A1	WASHING SYSTEM ROTOR BUSH	1	PZ	UG1005B1	LONG RAY ROTOR WATER NOZZL	1	PZ	UG1006B3	LONG RAY ROTOR WATER NOZZL	1	PZ	VI1220A1	4,2X12 TCB SELF-TAPPIN G SCREW	6	PZ	VM1955C0	WASHING SYSTEM ROTOR	1	PZ	VM1985C1	WASHING SYSTEM ROTOR COVE	1	PZ	VM1986A0	NOZZLE COVE	1	PZ
Code	Description	Qty	UOM																																										
GN1416B0	WASHING SYSTEM ROTOR BEARING	1	PZ																																										
TF1065B0	WASHING SYSTEM ROTOR PIVOT	1	PZ																																										
TF1066A1	WASHING SYSTEM ROTOR BUSH	1	PZ																																										
UG1005B1	LONG RAY ROTOR WATER NOZZL	1	PZ																																										
UG1006B3	LONG RAY ROTOR WATER NOZZL	1	PZ																																										
VI1220A1	4,2X12 TCB SELF-TAPPIN G SCREW	6	PZ																																										
VM1955C0	WASHING SYSTEM ROTOR	1	PZ																																										
VM1985C1	WASHING SYSTEM ROTOR COVE	1	PZ																																										
VM1986A0	NOZZLE COVE	1	PZ																																										
0H2551A	XBC/XVC ST.STEEL DRAIN COVER		0H2551A0	XBC/XVC ST.STEEL DRAIN COVER																																									



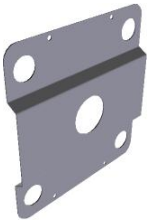

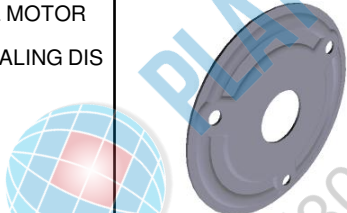
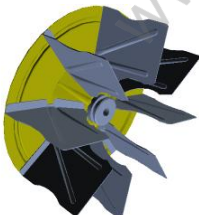
COMPONENT			SPARE PART																														
Code	Description	Image	Code	Description	Components list																												
VM1820A	LATERAL SUPPORTS M6 FIXING BOLTS		KVM1820A	S.5 CHROMIUM PL. THUB SCREWS 10PCS KIT	<table border="1"> <thead> <tr> <th>Code</th> <th>Description</th> <th>Qty</th> <th>UOM</th> </tr> </thead> <tbody> <tr> <td>VM1820A0</td> <td>LATERAL SUPPORTS M6 FIXING BOLTS</td> <td>10</td> <td>PZ</td> </tr> </tbody> </table>	Code	Description	Qty	UOM	VM1820A0	LATERAL SUPPORTS M6 FIXING BOLTS	10	PZ																				
Code	Description	Qty	UOM																														
VM1820A0	LATERAL SUPPORTS M6 FIXING BOLTS	10	PZ																														
VM2331A	FAN GUARD-TRAYS HOLDER PIN		KVM2331A	KIT FAN GUARD-TRAYS HOLDER PIN	<table border="1"> <thead> <tr> <th>Code</th> <th>Description</th> <th>Qty</th> <th>UOM</th> </tr> </thead> <tbody> <tr> <td>VM2331A0</td> <td>FAN GUARD-TRAY S HOLDER PIN</td> <td>4</td> <td>PZ</td> </tr> </tbody> </table>	Code	Description	Qty	UOM	VM2331A0	FAN GUARD-TRAY S HOLDER PIN	4	PZ																				
Code	Description	Qty	UOM																														
VM2331A0	FAN GUARD-TRAY S HOLDER PIN	4	PZ																														
OG1596A	XEBC-06EU-G FAN GUARD																																
MT1012A	330W 230V MOTOR		KMT1012A	MIND.MAPS 330W 230V MOTOR KIT	<table border="1"> <thead> <tr> <th>Code</th> <th>Description</th> <th>Qty</th> <th>UOM</th> </tr> </thead> <tbody> <tr> <td>GN1140A2</td> <td>MOTOR HOLDER GASKET</td> <td>1</td> <td>PZ</td> </tr> <tr> <td>MT1012A0</td> <td>330W 230V MOTOR</td> <td>1</td> <td>PZ</td> </tr> <tr> <td>VI1077A1</td> <td>SCREW M6X12 TE INOX</td> <td>1</td> <td>PZ</td> </tr> <tr> <td>VI1521A0</td> <td>STAINLESS STEEL WASHER D=6 6592</td> <td>1</td> <td>PZ</td> </tr> <tr> <td>VM1794A0</td> <td>250X4.8 PA66 BLACK CLAMP</td> <td>4</td> <td>PZ</td> </tr> <tr> <td>VM2103A0</td> <td>CLAMP LOCK</td> <td>4</td> <td>PZ</td> </tr> </tbody> </table>	Code	Description	Qty	UOM	GN1140A2	MOTOR HOLDER GASKET	1	PZ	MT1012A0	330W 230V MOTOR	1	PZ	VI1077A1	SCREW M6X12 TE INOX	1	PZ	VI1521A0	STAINLESS STEEL WASHER D=6 6592	1	PZ	VM1794A0	250X4.8 PA66 BLACK CLAMP	4	PZ	VM2103A0	CLAMP LOCK	4	PZ
Code	Description	Qty	UOM																														
GN1140A2	MOTOR HOLDER GASKET	1	PZ																														
MT1012A0	330W 230V MOTOR	1	PZ																														
VI1077A1	SCREW M6X12 TE INOX	1	PZ																														
VI1521A0	STAINLESS STEEL WASHER D=6 6592	1	PZ																														
VM1794A0	250X4.8 PA66 BLACK CLAMP	4	PZ																														
VM2103A0	CLAMP LOCK	4	PZ																														

COMPONENT			SPARE PART																						
Code	Description	Image	Code	Description	Components list																				
0H7170A	MM MOTOR GLASS WOOL PLATE		0H7170A0	MM MOTOR GLASS WOOL PLATE																					
GN1140A	MOTOR HOLDER GASKET		KGN1140A	5 PCS. MOTOR SUPP. GASKET KIT	<table border="1"> <thead> <tr> <th>Code</th> <th>Description</th> <th>Qty</th> <th>UOM</th> </tr> </thead> <tbody> <tr> <td>GN1140A2</td> <td>MOTOR HOLDER GASKET</td> <td>5</td> <td>PZ</td> </tr> </tbody> </table>	Code	Description	Qty	UOM	GN1140A2	MOTOR HOLDER GASKET	5	PZ												
Code	Description	Qty	UOM																						
GN1140A2	MOTOR HOLDER GASKET	5	PZ																						
0H4305A	ST. STEEL MOTOR SHAFT SEALING DIS		K0H4305A	SEALING DISC FOR MOTOR SHAFT KIT	<table border="1"> <thead> <tr> <th>Code</th> <th>Description</th> <th>Qty</th> <th>UOM</th> </tr> </thead> <tbody> <tr> <td>0H4305A1</td> <td>ST. STEEL MOTOR SHAFT SEALING DISC</td> <td>1</td> <td>PZ</td> </tr> <tr> <td>GN1140A2</td> <td>MOTOR HOLDER GASKET</td> <td>1</td> <td>PZ</td> </tr> <tr> <td>SL1045A0</td> <td>S53 BLACK SILICONE - 80ML CARTRIDGE</td> <td>1</td> <td>PZ</td> </tr> <tr> <td>VI1220A1</td> <td>4,2X12 TCB SELF-TAPPIN G SCREW</td> <td>3</td> <td>PZ</td> </tr> </tbody> </table>	Code	Description	Qty	UOM	0H4305A1	ST. STEEL MOTOR SHAFT SEALING DISC	1	PZ	GN1140A2	MOTOR HOLDER GASKET	1	PZ	SL1045A0	S53 BLACK SILICONE - 80ML CARTRIDGE	1	PZ	VI1220A1	4,2X12 TCB SELF-TAPPIN G SCREW	3	PZ
Code	Description	Qty	UOM																						
0H4305A1	ST. STEEL MOTOR SHAFT SEALING DISC	1	PZ																						
GN1140A2	MOTOR HOLDER GASKET	1	PZ																						
SL1045A0	S53 BLACK SILICONE - 80ML CARTRIDGE	1	PZ																						
VI1220A1	4,2X12 TCB SELF-TAPPIN G SCREW	3	PZ																						
VN1170A	D195 H80 8 BLADES FAN		KVN1170B	D195 H80 8 BLADES FAN + RING KIT	<table border="1"> <thead> <tr> <th>Code</th> <th>Description</th> <th>Qty</th> <th>UOM</th> </tr> </thead> <tbody> <tr> <td>VI1077A1</td> <td>SCREW M6X12 TE INOX</td> <td>1</td> <td>PZ</td> </tr> <tr> <td>VI1521A0</td> <td>STAINLESS STEEL WASHER D=6 6592</td> <td>1</td> <td>PZ</td> </tr> <tr> <td>VN1170B0</td> <td>D195 H80 8 BLADES FAN+RING</td> <td>1</td> <td>PZ</td> </tr> </tbody> </table>	Code	Description	Qty	UOM	VI1077A1	SCREW M6X12 TE INOX	1	PZ	VI1521A0	STAINLESS STEEL WASHER D=6 6592	1	PZ	VN1170B0	D195 H80 8 BLADES FAN+RING	1	PZ				
Code	Description	Qty	UOM																						
VI1077A1	SCREW M6X12 TE INOX	1	PZ																						
VI1521A0	STAINLESS STEEL WASHER D=6 6592	1	PZ																						
VN1170B0	D195 H80 8 BLADES FAN+RING	1	PZ																						
			KVN1170A	D195 H80 8 BLADES FAN KIT	<table border="1"> <thead> <tr> <th>Code</th> <th>Description</th> <th>Qty</th> <th>UOM</th> </tr> </thead> <tbody> <tr> <td>VI1077A1</td> <td>SCREW M6X12 TE INOX</td> <td>1</td> <td>PZ</td> </tr> <tr> <td>VI1521A0</td> <td>STAINLESS STEEL WASHER D=6 6592</td> <td>1</td> <td>PZ</td> </tr> </tbody> </table>	Code	Description	Qty	UOM	VI1077A1	SCREW M6X12 TE INOX	1	PZ	VI1521A0	STAINLESS STEEL WASHER D=6 6592	1	PZ								
Code	Description	Qty	UOM																						
VI1077A1	SCREW M6X12 TE INOX	1	PZ																						
VI1521A0	STAINLESS STEEL WASHER D=6 6592	1	PZ																						



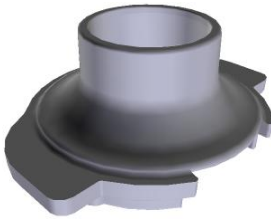

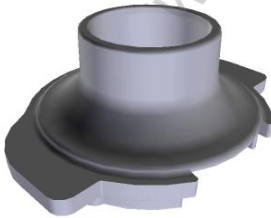

COMPONENT			SPARE PART														
Code	Description	Image	Code	Description	Components list												
VN1170A	D195 H80 8 BLADES FAN		KVN1170A	D195 H80 8 BLADES FAN KIT	<table border="1"> <thead> <tr> <th>Code</th> <th>Description</th> <th>Qty</th> <th>UOM</th> </tr> </thead> <tbody> <tr> <td>VN1170A2</td> <td>D195 H80 8 BLADES FAN</td> <td>1</td> <td>PZ</td> </tr> <tr> <td>VN1170B0</td> <td>D195 H80 8 BLADES FAN+RING</td> <td>1</td> <td>PZ</td> </tr> </tbody> </table>	Code	Description	Qty	UOM	VN1170A2	D195 H80 8 BLADES FAN	1	PZ	VN1170B0	D195 H80 8 BLADES FAN+RING	1	PZ
Code	Description	Qty	UOM														
VN1170A2	D195 H80 8 BLADES FAN	1	PZ														
VN1170B0	D195 H80 8 BLADES FAN+RING	1	PZ														
TB2902A	GAS OVENS CHAMBER CHIMNEY PIPE D50		TB2902A0	GAS OVENS CHAMBER CHIMNEY PIPE D50													
0H7231A	XEVC GAS CHAMBER RIGHT HOLDING BRACKET		0H7231A0	XEVC GAS CHAMBER RIGHT HOLDING BRACKET													
0H7230A	XEVC GAS CHAMBER LEFT HOLDING BRACKET		0H7230A0	XEVC GAS CHAMBER LEFT HOLDING BRACKET													
VM2332A	WATER PIPE BUSHING		KVM2332A	WATER PIPE BUSHING KIT VM2332A0	<table border="1"> <thead> <tr> <th>Code</th> <th>Description</th> <th>Qty</th> <th>UOM</th> </tr> </thead> <tbody> <tr> <td>VM2332A0</td> <td>WATER PIPE BUSHING</td> <td>1</td> <td>PZ</td> </tr> </tbody> </table>	Code	Description	Qty	UOM	VM2332A0	WATER PIPE BUSHING	1	PZ				
Code	Description	Qty	UOM														
VM2332A0	WATER PIPE BUSHING	1	PZ														



COMPONENT			SPARE PART										
Code	Description	Image	Code	Description	Components list								
VM2251A	STEAM WATER INLET UPPER DISTRIBUTOR		KVM2251A	STEAM WATER INLET DISTRIBUTORS KIT	<table border="1"> <thead> <tr> <th>Code</th> <th>Description</th> <th>Qty</th> <th>UOM</th> </tr> </thead> <tbody> <tr> <td>VM2251A0</td> <td>STEAM WATER INLET UPPER DISTRIBUTOR</td> <td>1</td> <td>PZ</td> </tr> </tbody> </table>	Code	Description	Qty	UOM	VM2251A0	STEAM WATER INLET UPPER DISTRIBUTOR	1	PZ
					Code	Description	Qty	UOM					
VM2251A0	STEAM WATER INLET UPPER DISTRIBUTOR	1	PZ										
<table border="1"> <thead> <tr> <th>Code</th> <th>Description</th> <th>Qty</th> <th>UOM</th> </tr> </thead> <tbody> <tr> <td>VM2252A0</td> <td>STEAM WATER INLET LOWER DISTRIBUTOR</td> <td>1</td> <td>PZ</td> </tr> </tbody> </table>	Code	Description	Qty	UOM	VM2252A0	STEAM WATER INLET LOWER DISTRIBUTOR	1	PZ					
Code	Description	Qty	UOM										
VM2252A0	STEAM WATER INLET LOWER DISTRIBUTOR	1	PZ										
VM2252A	STEAM WATER INLET LOWER DISTRIBUTOR		KVM2252A	STEAM WATER INLET LOWER DISTRIBUTOR KIT	<table border="1"> <thead> <tr> <th>Code</th> <th>Description</th> <th>Qty</th> <th>UOM</th> </tr> </thead> <tbody> <tr> <td>VM2252A0</td> <td>STEAM WATER INLET LOWER DISTRIBUTOR</td> <td>1</td> <td>PZ</td> </tr> </tbody> </table>	Code	Description	Qty	UOM	VM2252A0	STEAM WATER INLET LOWER DISTRIBUTOR	1	PZ
					Code	Description	Qty	UOM					
VM2252A0	STEAM WATER INLET LOWER DISTRIBUTOR	1	PZ										
<table border="1"> <thead> <tr> <th>Code</th> <th>Description</th> <th>Qty</th> <th>UOM</th> </tr> </thead> <tbody> <tr> <td>VM2251A0</td> <td>STEAM WATER INLET UPPER DISTRIBUTOR</td> <td>1</td> <td>PZ</td> </tr> <tr> <td>VM2252A0</td> <td>STEAM WATER INLET LOWER DISTRIBUTOR</td> <td>1</td> <td>PZ</td> </tr> </tbody> </table>	Code	Description	Qty	UOM	VM2251A0	STEAM WATER INLET UPPER DISTRIBUTOR	1	PZ	VM2252A0	STEAM WATER INLET LOWER DISTRIBUTOR	1	PZ	
Code	Description	Qty	UOM										
VM2251A0	STEAM WATER INLET UPPER DISTRIBUTOR	1	PZ										
VM2252A0	STEAM WATER INLET LOWER DISTRIBUTOR	1	PZ										
TB3063A	XEBC-10EU-G 3 WAYS WATER PIPE		TB3063A0	XEBC-10EU-G 3 WAYS WATER PIPE									
VM2251A	STEAM WATER INLET UPPER DISTRIBUTOR		KVM2251A	STEAM WATER INLET DISTRIBUTORS KIT	<table border="1"> <thead> <tr> <th>Code</th> <th>Description</th> <th>Qty</th> <th>UOM</th> </tr> </thead> <tbody> <tr> <td>VM2251A0</td> <td>STEAM WATER INLET UPPER DISTRIBUTOR</td> <td>1</td> <td>PZ</td> </tr> </tbody> </table>	Code	Description	Qty	UOM	VM2251A0	STEAM WATER INLET UPPER DISTRIBUTOR	1	PZ
					Code	Description	Qty	UOM					
VM2251A0	STEAM WATER INLET UPPER DISTRIBUTOR	1	PZ										
<table border="1"> <thead> <tr> <th>Code</th> <th>Description</th> <th>Qty</th> <th>UOM</th> </tr> </thead> <tbody> <tr> <td>VM2252A0</td> <td>STEAM WATER INLET LOWER DISTRIBUTOR</td> <td>1</td> <td>PZ</td> </tr> </tbody> </table>	Code	Description	Qty	UOM	VM2252A0	STEAM WATER INLET LOWER DISTRIBUTOR	1	PZ					
Code	Description	Qty	UOM										
VM2252A0	STEAM WATER INLET LOWER DISTRIBUTOR	1	PZ										



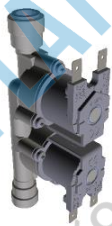

COMPONENT			SPARE PART											
Code	Description	Image	Code	Description	Components list									
VM2252A	STEAM WATER INLET LOWER DISTRIBUTOR		KVM2252A	STEAM WATER INLET LOWER DISTRIBUTOR KIT	<table border="1"> <thead> <tr> <th>Code</th> <th>Description</th> <th>Qty</th> <th>UOM</th> </tr> </thead> <tbody> <tr> <td>VM2252A0</td> <td>STEAM WATER INLET LOWER DISTRIBUTOR</td> <td>1</td> <td>PZ</td> </tr> </tbody> </table>	Code	Description	Qty	UOM	VM2252A0	STEAM WATER INLET LOWER DISTRIBUTOR	1	PZ	
			Code	Description	Qty	UOM								
VM2252A0	STEAM WATER INLET LOWER DISTRIBUTOR	1	PZ											
KVM2251A	STEAM WATER INLET DISTRIBUTORS KIT	<table border="1"> <thead> <tr> <th>Code</th> <th>Description</th> <th>Qty</th> <th>UOM</th> </tr> </thead> <tbody> <tr> <td>VM2251A0</td> <td>STEAM WATER INLET UPPER DISTRIBUTOR</td> <td>1</td> <td>PZ</td> </tr> <tr> <td>VM2252A0</td> <td>STEAM WATER INLET LOWER DISTRIBUTOR</td> <td>1</td> <td>PZ</td> </tr> </tbody> </table>	Code	Description	Qty	UOM	VM2251A0	STEAM WATER INLET UPPER DISTRIBUTOR	1	PZ	VM2252A0	STEAM WATER INLET LOWER DISTRIBUTOR	1	PZ
Code	Description	Qty	UOM											
VM2251A0	STEAM WATER INLET UPPER DISTRIBUTOR	1	PZ											
VM2252A0	STEAM WATER INLET LOWER DISTRIBUTOR	1	PZ											
TB3065A	XEBC-10EU-G 2 WAYS WATER PIPE		TB3065A0	XEBC-10EU-G 2 WAYS WATER PIPE										
TB3066A	XEBC-10EU-G LOWER HUMIDITY PIPE		TB3066A0	XEBC-10EU-G LOWER HUMIDITY PIPE										
0G1618A	XEBC-10EU-GP* FAN GUARD+STIFFENIN G BAR		0G1618A0	XEBC-10EU-GP* FAN GUARD+STIFFENIN G BAR										

COMPONENT			SPARE PART										
Code	Description	Image	Code	Description	Components list								
0G1619A			0G1619A0										
RC1170A	STAINLESS STEEL NUT M14 H=8 CH=22		KRC1170A	M14 H8 CH22 NUT - 10 PCS. KIT	<table border="1"> <thead> <tr> <th>Code</th> <th>Description</th> <th>Qty</th> <th>UOM</th> </tr> </thead> <tbody> <tr> <td>RC1170A1</td> <td>STAINLESS STEEL NUT M14 H=8 CH=2</td> <td>10</td> <td>PZ</td> </tr> </tbody> </table>	Code	Description	Qty	UOM	RC1170A1	STAINLESS STEEL NUT M14 H=8 CH=2	10	PZ
Code	Description	Qty	UOM										
RC1170A1	STAINLESS STEEL NUT M14 H=8 CH=2	10	PZ										
ASM1748A	General overview		ASM1748A0	General overview									
VM2344A	ANTISCALE MAGNET HOLDER HALF COVER		KVM2344A	ANTI-LIMESCALE MAGNET HALF BEARING KIT	<table border="1"> <thead> <tr> <th>Code</th> <th>Description</th> <th>Qty</th> <th>UOM</th> </tr> </thead> <tbody> <tr> <td>VM2344A0</td> <td>ANTISCALE MAGNET HOLDER HALF COVER</td> <td>2</td> <td>PZ</td> </tr> </tbody> </table>	Code	Description	Qty	UOM	VM2344A0	ANTISCALE MAGNET HOLDER HALF COVER	2	PZ
Code	Description	Qty	UOM										
VM2344A0	ANTISCALE MAGNET HOLDER HALF COVER	2	PZ										
VL1086A	LIMESCALE REMOVER NEODYMIUM MAGNET		KVL1086A	NEODYMIUM MAGNET ANTI-LIMESCALE KI	<table border="1"> <thead> <tr> <th>Code</th> <th>Description</th> <th>Qty</th> <th>UOM</th> </tr> </thead> <tbody> <tr> <td>VL1086A0</td> <td>LIMESCALE REMOVER NEODYMIUM MAGNET</td> <td>2</td> <td>PZ</td> </tr> </tbody> </table>	Code	Description	Qty	UOM	VL1086A0	LIMESCALE REMOVER NEODYMIUM MAGNET	2	PZ
Code	Description	Qty	UOM										
VL1086A0	LIMESCALE REMOVER NEODYMIUM MAGNET	2	PZ										









COMPONENT			SPARE PART										
Code	Description	Image	Code	Description	Components list								
RC1019A	D=10 ELASTIC CLAM		KRC1019A	Ø10 ZINC PLATED ELASTIC CLAMP 15 PCS KIT	<table border="1"> <thead> <tr> <th>Code</th> <th>Description</th> <th>Qty</th> <th>UOM</th> </tr> </thead> <tbody> <tr> <td>RC1019A0</td> <td>D=10 ELASTIC CLAMP</td> <td>15</td> <td>PZ</td> </tr> </tbody> </table>	Code	Description	Qty	UOM	RC1019A0	D=10 ELASTIC CLAMP	15	PZ
Code	Description	Qty	UOM										
RC1019A0	D=10 ELASTIC CLAMP	15	PZ										
TB2909A	XEVC EXTERNAL WATER PIPE D10 +CONNECTION		KTB2909A	Ø10 EXT WATER PIPE KIT XEVC GAS PLUS	<table border="1"> <thead> <tr> <th>Code</th> <th>Description</th> <th>Qty</th> <th>UOM</th> </tr> </thead> <tbody> <tr> <td>TB2909A0</td> <td>XEVC EXTERNAL WATER PIPE D10 +CONNECTIO</td> <td>1</td> <td>PZ</td> </tr> </tbody> </table>	Code	Description	Qty	UOM	TB2909A0	XEVC EXTERNAL WATER PIPE D10 +CONNECTIO	1	PZ
Code	Description	Qty	UOM										
TB2909A0	XEVC EXTERNAL WATER PIPE D10 +CONNECTIO	1	PZ										
EL1430A	5+21 STEAM SOLENOID VALVE		KEL1430A	5+21 STEAM SOLENOID VALVE KI	<table border="1"> <thead> <tr> <th>Code</th> <th>Description</th> <th>Qty</th> <th>UOM</th> </tr> </thead> <tbody> <tr> <td>EL1430A0</td> <td>5+21 STEAM SOLENOID VALVE</td> <td>1</td> <td>PZ</td> </tr> </tbody> </table>	Code	Description	Qty	UOM	EL1430A0	5+21 STEAM SOLENOID VALVE	1	PZ
Code	Description	Qty	UOM										
EL1430A0	5+21 STEAM SOLENOID VALVE	1	PZ										
VI1555A	Ø6 ST. STEEL SCHNOOR KNURLED WASHER		VI1555A0	Ø6 ST. STEEL SCHNOOR KNURLED WASHER									
ASM1759A	Lateral supports		ASM1759A0	Lateral supports									

COMPONENT			SPARE PART																																		
Code	Description	Image	Code	Description	Components list																																
GRL1407A	10X600X400 LEFT LATERAL SUPPORT		KGRL1408A	MM 10 ONE 600X400 LATERAL SUPPORTS KIT	<table border="1"> <thead> <tr> <th>Code</th> <th>Description</th> <th>Qty</th> <th>UOM</th> </tr> </thead> <tbody> <tr> <td>0H4215A0</td> <td>TRAYS GUIDE PROFILE L372.5 BT</td> <td>20</td> <td>PZ</td> </tr> <tr> <td>0H4420A0</td> <td>STAINLESS STEEL CORE TEMPERATUR</td> <td>1</td> <td>PZ</td> </tr> <tr> <td>0H7340A0</td> <td>0H7342+0H734 3 FLAT SUPPORTING PROFILE</td> <td>2</td> <td>PZ</td> </tr> <tr> <td>0H7341A0</td> <td>0H7343+0H734 4 FLAT SUPPORTING PROFILE</td> <td>2</td> <td>PZ</td> </tr> <tr> <td>VM1059A1</td> <td>HEAT SHRINK FILM H800</td> <td>1.500</td> <td>M</td> </tr> </tbody> </table>	Code	Description	Qty	UOM	0H4215A0	TRAYS GUIDE PROFILE L372.5 BT	20	PZ	0H4420A0	STAINLESS STEEL CORE TEMPERATUR	1	PZ	0H7340A0	0H7342+0H734 3 FLAT SUPPORTING PROFILE	2	PZ	0H7341A0	0H7343+0H734 4 FLAT SUPPORTING PROFILE	2	PZ	VM1059A1	HEAT SHRINK FILM H800	1.500	M								
Code	Description	Qty	UOM																																		
0H4215A0	TRAYS GUIDE PROFILE L372.5 BT	20	PZ																																		
0H4420A0	STAINLESS STEEL CORE TEMPERATUR	1	PZ																																		
0H7340A0	0H7342+0H734 3 FLAT SUPPORTING PROFILE	2	PZ																																		
0H7341A0	0H7343+0H734 4 FLAT SUPPORTING PROFILE	2	PZ																																		
VM1059A1	HEAT SHRINK FILM H800	1.500	M																																		
GRL1408A	10X600X400 RIGHT LATERAL SUPPORT		KGRL1408A	MM 10 ONE 600X400 LATERAL SUPPORTS KIT	<table border="1"> <thead> <tr> <th>Code</th> <th>Description</th> <th>Qty</th> <th>UOM</th> </tr> </thead> <tbody> <tr> <td>0H4215A0</td> <td>TRAYS GUIDE PROFILE L372.5 BT</td> <td>20</td> <td>PZ</td> </tr> <tr> <td>0H4420A0</td> <td>STAINLESS STEEL CORE TEMPERATUR</td> <td>1</td> <td>PZ</td> </tr> <tr> <td>0H7340A0</td> <td>0H7342+0H734 3 FLAT SUPPORTING PROFILE</td> <td>2</td> <td>PZ</td> </tr> <tr> <td>0H7341A0</td> <td>0H7343+0H734 4 FLAT SUPPORTING PROFILE</td> <td>2</td> <td>PZ</td> </tr> <tr> <td>VM1059A1</td> <td>HEAT SHRINK FILM H800</td> <td>1.500</td> <td>M</td> </tr> </tbody> </table>	Code	Description	Qty	UOM	0H4215A0	TRAYS GUIDE PROFILE L372.5 BT	20	PZ	0H4420A0	STAINLESS STEEL CORE TEMPERATUR	1	PZ	0H7340A0	0H7342+0H734 3 FLAT SUPPORTING PROFILE	2	PZ	0H7341A0	0H7343+0H734 4 FLAT SUPPORTING PROFILE	2	PZ	VM1059A1	HEAT SHRINK FILM H800	1.500	M								
Code	Description	Qty	UOM																																		
0H4215A0	TRAYS GUIDE PROFILE L372.5 BT	20	PZ																																		
0H4420A0	STAINLESS STEEL CORE TEMPERATUR	1	PZ																																		
0H7340A0	0H7342+0H734 3 FLAT SUPPORTING PROFILE	2	PZ																																		
0H7341A0	0H7343+0H734 4 FLAT SUPPORTING PROFILE	2	PZ																																		
VM1059A1	HEAT SHRINK FILM H800	1.500	M																																		
SN1002A	MULTI.POINT CORE PROBE L2050		KSN1020A	US MULTIPPOINT L2050 CORE PROBE KIT	<table border="1"> <thead> <tr> <th>Code</th> <th>Description</th> <th>Qty</th> <th>UOM</th> </tr> </thead> <tbody> <tr> <td>0H7374A0</td> <td>CORE PROBE CABLE PLATE</td> <td>1</td> <td>PZ</td> </tr> <tr> <td>CE1037A0</td> <td>UL SILICON GLASS FIBER SHEATH</td> <td>0.700</td> <td>M</td> </tr> <tr> <td>CE1685A0</td> <td>MRT8 P3,81 5 POLES FEMALE TERMINAL</td> <td>1</td> <td>PZ</td> </tr> <tr> <td>RC1130A0</td> <td>130X2,6 CLAM</td> <td>2</td> <td>PZ</td> </tr> <tr> <td>SN1002A1</td> <td>L=2050 MULTI.POINT CORE PROBE</td> <td>1</td> <td>PZ</td> </tr> <tr> <td>SN1002A2</td> <td>L=2050 MULTI.POINT CORE PROBE</td> <td>1</td> <td>PZ</td> </tr> <tr> <td>SN1002A3</td> <td>MULTI.POINT CORE PROBE L2050</td> <td>1</td> <td>PZ</td> </tr> </tbody> </table>	Code	Description	Qty	UOM	0H7374A0	CORE PROBE CABLE PLATE	1	PZ	CE1037A0	UL SILICON GLASS FIBER SHEATH	0.700	M	CE1685A0	MRT8 P3,81 5 POLES FEMALE TERMINAL	1	PZ	RC1130A0	130X2,6 CLAM	2	PZ	SN1002A1	L=2050 MULTI.POINT CORE PROBE	1	PZ	SN1002A2	L=2050 MULTI.POINT CORE PROBE	1	PZ	SN1002A3	MULTI.POINT CORE PROBE L2050	1	PZ
Code	Description	Qty	UOM																																		
0H7374A0	CORE PROBE CABLE PLATE	1	PZ																																		
CE1037A0	UL SILICON GLASS FIBER SHEATH	0.700	M																																		
CE1685A0	MRT8 P3,81 5 POLES FEMALE TERMINAL	1	PZ																																		
RC1130A0	130X2,6 CLAM	2	PZ																																		
SN1002A1	L=2050 MULTI.POINT CORE PROBE	1	PZ																																		
SN1002A2	L=2050 MULTI.POINT CORE PROBE	1	PZ																																		
SN1002A3	MULTI.POINT CORE PROBE L2050	1	PZ																																		

COMPONENT			SPARE PART																										
Code	Description	Image	Code	Description	Components list																								
SN1002A	MULTI.POINT CORE PROBE L2050		KSN1002A	MULTIPOINT CORE PROBE KIT L2050	<table border="1"> <thead> <tr> <th>Code</th> <th>Description</th> <th>Qty</th> <th>UOM</th> </tr> </thead> <tbody> <tr> <td>0H7374A0</td> <td>CORE PROBE CABLE PLATE</td> <td>1</td> <td>PZ</td> </tr> <tr> <td>CE1685A0</td> <td>MRT8 P3,81 5 POLES FEMALE TERMINAL</td> <td>1</td> <td>PZ</td> </tr> <tr> <td>SN1002A1</td> <td>L=2050 MULTI.POINT CORE PROBE</td> <td>1</td> <td>PZ</td> </tr> <tr> <td>SN1002A2</td> <td>L=2050 MULTI.POINT CORE PROBE</td> <td>1</td> <td>PZ</td> </tr> <tr> <td>SN1002A3</td> <td>MULTI.POINT CORE PROBE L2050</td> <td>1</td> <td>PZ</td> </tr> </tbody> </table>	Code	Description	Qty	UOM	0H7374A0	CORE PROBE CABLE PLATE	1	PZ	CE1685A0	MRT8 P3,81 5 POLES FEMALE TERMINAL	1	PZ	SN1002A1	L=2050 MULTI.POINT CORE PROBE	1	PZ	SN1002A2	L=2050 MULTI.POINT CORE PROBE	1	PZ	SN1002A3	MULTI.POINT CORE PROBE L2050	1	PZ
Code	Description	Qty	UOM																										
0H7374A0	CORE PROBE CABLE PLATE	1	PZ																										
CE1685A0	MRT8 P3,81 5 POLES FEMALE TERMINAL	1	PZ																										
SN1002A1	L=2050 MULTI.POINT CORE PROBE	1	PZ																										
SN1002A2	L=2050 MULTI.POINT CORE PROBE	1	PZ																										
SN1002A3	MULTI.POINT CORE PROBE L2050	1	PZ																										
VI2018A	NUT M6		VI2018A0	NUT M6																									
ASM3119A	Lateral supports		ASM3119A0	Lateral supports																									
PE1710B	MOTOR REVOLUTION AND DIRECTION SENSO		KPE1710B	MOTOR REVOLUTIONS SENSOR KIT	<table border="1"> <thead> <tr> <th>Code</th> <th>Description</th> <th>Qty</th> <th>UOM</th> </tr> </thead> <tbody> <tr> <td>PE1710B0</td> <td>MOTOR REVOLUTION AND DIRECTION SENSOR</td> <td>1</td> <td>PZ</td> </tr> <tr> <td>VE1550A0</td> <td>5X3 MM NEODYMIUM MAGNET</td> <td>1</td> <td>PZ</td> </tr> <tr> <td>VI1966A0</td> <td>M4X14 FLATHEAD SCREW</td> <td>1</td> <td>PZ</td> </tr> <tr> <td>VM1635A0</td> <td>MAGNET HOLDING DIS</td> <td>1</td> <td>PZ</td> </tr> </tbody> </table>	Code	Description	Qty	UOM	PE1710B0	MOTOR REVOLUTION AND DIRECTION SENSOR	1	PZ	VE1550A0	5X3 MM NEODYMIUM MAGNET	1	PZ	VI1966A0	M4X14 FLATHEAD SCREW	1	PZ	VM1635A0	MAGNET HOLDING DIS	1	PZ				
Code	Description	Qty	UOM																										
PE1710B0	MOTOR REVOLUTION AND DIRECTION SENSOR	1	PZ																										
VE1550A0	5X3 MM NEODYMIUM MAGNET	1	PZ																										
VI1966A0	M4X14 FLATHEAD SCREW	1	PZ																										
VM1635A0	MAGNET HOLDING DIS	1	PZ																										



COMPONENT			SPARE PART																		
Code	Description	Image	Code	Description	Components list																
VE1550A	5X3 MM NEODYMIUM MAGNET		VE1550A0	5X3 MM NEODYMIUM MAGNET																	
ASM3113A	Burner		ASM3113A0	Burner																	
TR1113A	TEMPERATURE PROBE TC K L1825 AMPMODU 2P		KTR1113A	EXHAUST FUMES 2P TEMPERATURE PROBE KIT	<table border="1"> <thead> <tr> <th>Code</th> <th>Description</th> <th>Qty</th> <th>UOM</th> </tr> </thead> <tbody> <tr> <td>GN1583A0</td> <td>FUME PROBE'S GASKET</td> <td>1</td> <td>PZ</td> </tr> <tr> <td>TR1113A0</td> <td>TEMPERATUR E PROBE TC K L1825 AMPMODU 2P</td> <td>1</td> <td>PZ</td> </tr> <tr> <td>VI1220A1</td> <td>4,2X12 TCB SELF-TAPPIN G SCREW</td> <td>3</td> <td>PZ</td> </tr> </tbody> </table>	Code	Description	Qty	UOM	GN1583A0	FUME PROBE'S GASKET	1	PZ	TR1113A0	TEMPERATUR E PROBE TC K L1825 AMPMODU 2P	1	PZ	VI1220A1	4,2X12 TCB SELF-TAPPIN G SCREW	3	PZ
Code	Description	Qty	UOM																		
GN1583A0	FUME PROBE'S GASKET	1	PZ																		
TR1113A0	TEMPERATUR E PROBE TC K L1825 AMPMODU 2P	1	PZ																		
VI1220A1	4,2X12 TCB SELF-TAPPIN G SCREW	3	PZ																		
GN1583A	FUME PROBE'S GASKET		GN1583A0	FUME PROBE'S GASKET																	
TR1114A	FUMES TEMP. PROBE TC K UL L1825 AMP 2P		TR1114A0	FUMES TEMP. PROBE TC K UL L1825 AMP 2P																	

COMPONENT			SPARE PART																																																														
Code	Description	Image	Code	Description	Components list																																																												
TR1113A	TEMPERATURE PROBE TC K L1825 AMPMODU 2P		KTR1113A	EXHAUST FUMES 2P TEMPERATURE PROBE KIT	<table border="1"> <thead> <tr> <th>Code</th> <th>Description</th> <th>Qty</th> <th>UOM</th> </tr> </thead> <tbody> <tr> <td>GN1583A0</td> <td>FUME PROBE'S GASKET</td> <td>1</td> <td>PZ</td> </tr> <tr> <td>TR1113A0</td> <td>TEMPERATUR E PROBE TC K L1825 AMPMODU 2P</td> <td>1</td> <td>PZ</td> </tr> <tr> <td>VI1220A1</td> <td>4,2X12 TCB SELF-TAPPIN G SCREW</td> <td>3</td> <td>PZ</td> </tr> </tbody> </table>	Code	Description	Qty	UOM	GN1583A0	FUME PROBE'S GASKET	1	PZ	TR1113A0	TEMPERATUR E PROBE TC K L1825 AMPMODU 2P	1	PZ	VI1220A1	4,2X12 TCB SELF-TAPPIN G SCREW	3	PZ																																												
Code	Description	Qty	UOM																																																														
GN1583A0	FUME PROBE'S GASKET	1	PZ																																																														
TR1113A0	TEMPERATUR E PROBE TC K L1825 AMPMODU 2P	1	PZ																																																														
VI1220A1	4,2X12 TCB SELF-TAPPIN G SCREW	3	PZ																																																														
ON1427C	XEBC-10EU-G RIGHT HEAT EXCHANGER KIT		KON1427C	RIGHT XEBC-10EU-G HEAT EXCHANGER KIT	<table border="1"> <thead> <tr> <th>Code</th> <th>Description</th> <th>Qty</th> <th>UOM</th> </tr> </thead> <tbody> <tr> <td>0H7741A1</td> <td>HEAT EXCH TIE ROD ANTI ROTATION PLATE</td> <td>2</td> <td>PZ</td> </tr> <tr> <td>ON1427C0</td> <td>XEBC-10EU-G RIGHT HEAT EXCHANGER KIT</td> <td>1</td> <td>PZ</td> </tr> <tr> <td>ON1427C1</td> <td></td> <td>1</td> <td>PZ</td> </tr> <tr> <td>ON1503A0</td> <td></td> <td>1</td> <td>PZ</td> </tr> <tr> <td>ON1503A1</td> <td></td> <td>1</td> <td>PZ</td> </tr> <tr> <td>GN1580A1</td> <td>GAS PIPE SCREW COPPER WASHER</td> <td>3</td> <td>PZ</td> </tr> <tr> <td>GR1070A0</td> <td>HEAT EXCH PIPE-COUNTE R PIPE RING</td> <td>2</td> <td>PZ</td> </tr> <tr> <td>IP1508A1</td> <td>POLYSTYREN E U SHAPED PROFILE 2000X60X60</td> <td>2</td> <td>M</td> </tr> <tr> <td>LV1085A0</td> <td>Ø4 ROUND GLASS FIBRE STRING</td> <td>0.820</td> <td>M</td> </tr> <tr> <td>LV1086A0</td> <td>Ø5 ROUND GLASS FIBRE STRING</td> <td>0.330</td> <td>M</td> </tr> <tr> <td>SL1045A0</td> <td>S53 BLACK SILICONE - 80ML CARTRIDGE</td> <td>1</td> <td>PZ</td> </tr> <tr> <td>VI1521A0</td> <td>STAINLESS STEEL WASHER D=6 6592</td> <td>3</td> <td>PZ</td> </tr> <tr> <td>VI2018A0</td> <td>NUT M6</td> <td>3</td> <td>PZ</td> </tr> <tr> <td>VM1059A1</td> <td>HEAT SHRINK FILM H800</td> <td>1</td> <td>M</td> </tr> </tbody> </table>	Code	Description	Qty	UOM	0H7741A1	HEAT EXCH TIE ROD ANTI ROTATION PLATE	2	PZ	ON1427C0	XEBC-10EU-G RIGHT HEAT EXCHANGER KIT	1	PZ	ON1427C1		1	PZ	ON1503A0		1	PZ	ON1503A1		1	PZ	GN1580A1	GAS PIPE SCREW COPPER WASHER	3	PZ	GR1070A0	HEAT EXCH PIPE-COUNTE R PIPE RING	2	PZ	IP1508A1	POLYSTYREN E U SHAPED PROFILE 2000X60X60	2	M	LV1085A0	Ø4 ROUND GLASS FIBRE STRING	0.820	M	LV1086A0	Ø5 ROUND GLASS FIBRE STRING	0.330	M	SL1045A0	S53 BLACK SILICONE - 80ML CARTRIDGE	1	PZ	VI1521A0	STAINLESS STEEL WASHER D=6 6592	3	PZ	VI2018A0	NUT M6	3	PZ	VM1059A1	HEAT SHRINK FILM H800	1	M
Code	Description	Qty	UOM																																																														
0H7741A1	HEAT EXCH TIE ROD ANTI ROTATION PLATE	2	PZ																																																														
ON1427C0	XEBC-10EU-G RIGHT HEAT EXCHANGER KIT	1	PZ																																																														
ON1427C1		1	PZ																																																														
ON1503A0		1	PZ																																																														
ON1503A1		1	PZ																																																														
GN1580A1	GAS PIPE SCREW COPPER WASHER	3	PZ																																																														
GR1070A0	HEAT EXCH PIPE-COUNTE R PIPE RING	2	PZ																																																														
IP1508A1	POLYSTYREN E U SHAPED PROFILE 2000X60X60	2	M																																																														
LV1085A0	Ø4 ROUND GLASS FIBRE STRING	0.820	M																																																														
LV1086A0	Ø5 ROUND GLASS FIBRE STRING	0.330	M																																																														
SL1045A0	S53 BLACK SILICONE - 80ML CARTRIDGE	1	PZ																																																														
VI1521A0	STAINLESS STEEL WASHER D=6 6592	3	PZ																																																														
VI2018A0	NUT M6	3	PZ																																																														
VM1059A1	HEAT SHRINK FILM H800	1	M																																																														

COMPONENT			SPARE PART																						
Code	Description	Image	Code	Description	Components list																				
0N1412B																									
ASM3118A	Exchanger		ASM3118A0	Exchanger																					
0N1412B																									
GN1568A	XEBC-10XX DOOR GASKET - GN1006A		KGN1568A	XEBC-10EU/FS/21DO OR GASKET KIT	<table border="1"> <thead> <tr> <th>Code</th> <th>Description</th> <th>Qty</th> <th>UOM</th> </tr> </thead> <tbody> <tr> <td>GN1006A1</td> <td>DOOR GASKE</td> <td>3.120</td> <td>M</td> </tr> <tr> <td>GN1008A0</td> <td>DOOR SEAL INTERNAL CONNECTION</td> <td>0.030</td> <td>M</td> </tr> <tr> <td>SL1025A0</td> <td>CLEAR SILICON DOW CORNING 734</td> <td>0.012</td> <td>PZ</td> </tr> <tr> <td>VM2277A0</td> <td>DOOR SEAL KIT INTERNAL CONNECTION</td> <td>1</td> <td>PZ</td> </tr> </tbody> </table>	Code	Description	Qty	UOM	GN1006A1	DOOR GASKE	3.120	M	GN1008A0	DOOR SEAL INTERNAL CONNECTION	0.030	M	SL1025A0	CLEAR SILICON DOW CORNING 734	0.012	PZ	VM2277A0	DOOR SEAL KIT INTERNAL CONNECTION	1	PZ
Code	Description	Qty	UOM																						
GN1006A1	DOOR GASKE	3.120	M																						
GN1008A0	DOOR SEAL INTERNAL CONNECTION	0.030	M																						
SL1025A0	CLEAR SILICON DOW CORNING 734	0.012	PZ																						
VM2277A0	DOOR SEAL KIT INTERNAL CONNECTION	1	PZ																						
ASM1873A	Venturi		ASM1873A0	Venturi																					



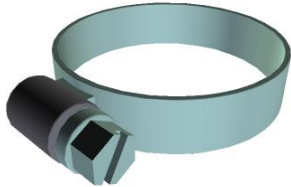



COMPONENT			SPARE PART																																																										
Code	Description	Image	Code	Description	Components list																																																								
RC1378A	HOSE CLAMP		KVE1135A	SERIES 5/5E VENTURI KIT	<table border="1"> <thead> <tr> <th>Code</th> <th>Description</th> <th>Qty</th> <th>UOM</th> </tr> </thead> <tbody> <tr> <td>GN1310A0</td> <td>VENTURI PIPE SEAL</td> <td>1</td> <td>PZ</td> </tr> <tr> <td>GN1556A0</td> <td>MM VENTURI SEAL</td> <td>1</td> <td>PZ</td> </tr> <tr> <td>RC1378A0</td> <td>HOSE CLAMP</td> <td>2</td> <td>PZ</td> </tr> <tr> <td>TB1520A0</td> <td>INT. Ø=38 TH=4 DRAIN BLACK RUBBER PIPE</td> <td>0.050</td> <td>M</td> </tr> <tr> <td>VE1135A0</td> <td>220 V 50/60 HZ VENTURI ACTUATOR</td> <td>1</td> <td>PZ</td> </tr> <tr> <td>VI1032A0</td> <td>SCREW M4X16 TCB+ INOX</td> <td>1</td> <td>PZ</td> </tr> <tr> <td>VI1511A0</td> <td>STAINLESS STEEL WASHER 4.2X12X1</td> <td>2</td> <td>PZ</td> </tr> <tr> <td>VI1850A0</td> <td>M4X6 NICKEL PLATED FIXING SCREW</td> <td>2</td> <td>PZ</td> </tr> <tr> <td>VI1865A0</td> <td>5X10 TCB+ SELF-THREADING SCREW</td> <td>3</td> <td>PZ</td> </tr> <tr> <td>VM1565B0</td> <td>VENTURI LOWER COIL SUPPORT</td> <td>1</td> <td>PZ</td> </tr> <tr> <td>VM1566A0</td> <td>VENTURI UPPER COIL SUPPORT</td> <td>1</td> <td>PZ</td> </tr> <tr> <td>VM1567A0</td> <td>VENTURI LOWER BUSHING</td> <td>1</td> <td>PZ</td> </tr> <tr> <td>VM1568A0</td> <td>VENTURI PLATE SPACE</td> <td>1</td> <td>PZ</td> </tr> </tbody> </table>	Code	Description	Qty	UOM	GN1310A0	VENTURI PIPE SEAL	1	PZ	GN1556A0	MM VENTURI SEAL	1	PZ	RC1378A0	HOSE CLAMP	2	PZ	TB1520A0	INT. Ø=38 TH=4 DRAIN BLACK RUBBER PIPE	0.050	M	VE1135A0	220 V 50/60 HZ VENTURI ACTUATOR	1	PZ	VI1032A0	SCREW M4X16 TCB+ INOX	1	PZ	VI1511A0	STAINLESS STEEL WASHER 4.2X12X1	2	PZ	VI1850A0	M4X6 NICKEL PLATED FIXING SCREW	2	PZ	VI1865A0	5X10 TCB+ SELF-THREADING SCREW	3	PZ	VM1565B0	VENTURI LOWER COIL SUPPORT	1	PZ	VM1566A0	VENTURI UPPER COIL SUPPORT	1	PZ	VM1567A0	VENTURI LOWER BUSHING	1	PZ	VM1568A0	VENTURI PLATE SPACE	1	PZ
					Code	Description	Qty	UOM																																																					
GN1310A0	VENTURI PIPE SEAL	1	PZ																																																										
GN1556A0	MM VENTURI SEAL	1	PZ																																																										
RC1378A0	HOSE CLAMP	2	PZ																																																										
TB1520A0	INT. Ø=38 TH=4 DRAIN BLACK RUBBER PIPE	0.050	M																																																										
VE1135A0	220 V 50/60 HZ VENTURI ACTUATOR	1	PZ																																																										
VI1032A0	SCREW M4X16 TCB+ INOX	1	PZ																																																										
VI1511A0	STAINLESS STEEL WASHER 4.2X12X1	2	PZ																																																										
VI1850A0	M4X6 NICKEL PLATED FIXING SCREW	2	PZ																																																										
VI1865A0	5X10 TCB+ SELF-THREADING SCREW	3	PZ																																																										
VM1565B0	VENTURI LOWER COIL SUPPORT	1	PZ																																																										
VM1566A0	VENTURI UPPER COIL SUPPORT	1	PZ																																																										
VM1567A0	VENTURI LOWER BUSHING	1	PZ																																																										
VM1568A0	VENTURI PLATE SPACE	1	PZ																																																										
GN1544A	AIR INLET GASKET		GN1544A0	AIR INLET GASKET																																																									



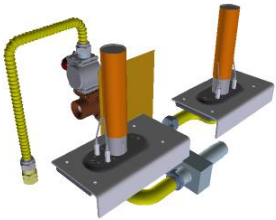

COMPONENT			SPARE PART																																																		
Code	Description	Image	Code	Description	Components list																																																
VM2377A	220 V 50/60 HZ VENTURI KIT		KVM2377A	MM VENTURI ACTUATOR SYSTEM KIT	<table border="1"> <thead> <tr> <th>Code</th> <th>Description</th> <th>Qty</th> <th>UOM</th> </tr> </thead> <tbody> <tr> <td>GN1556A0</td> <td>MM VENTURI SEAL</td> <td>1</td> <td>PZ</td> </tr> <tr> <td>RC1378A0</td> <td>HOSE CLAMP</td> <td>3</td> <td>PZ</td> </tr> <tr> <td>TB1520A0</td> <td>INT. Ø=38 TH=4 DRAIN BLACK RUBBER PIPE</td> <td>0.170</td> <td>M</td> </tr> <tr> <td>VE1135A0</td> <td>220 V 50/60 HZ VENTURI ACTUATOR</td> <td>1</td> <td>PZ</td> </tr> <tr> <td>VI1032A0</td> <td>SCREW M4X16 TCB+ INOX</td> <td>1</td> <td>PZ</td> </tr> <tr> <td>VI1220A1</td> <td>4,2X12 TCB SELF-TAPPIN G SCREW</td> <td>6</td> <td>PZ</td> </tr> <tr> <td>VM2345A0</td> <td>MM VENTURI UPPER HALF</td> <td>1</td> <td>PZ</td> </tr> <tr> <td>VM2346A0</td> <td>MM VENTURI LOWER HALF</td> <td>1</td> <td>PZ</td> </tr> <tr> <td>VM2347A0</td> <td>MIND.MAPS VENTURI COVER</td> <td>1</td> <td>PZ</td> </tr> <tr> <td>VM2348A0</td> <td>VENTURI PLATE SPACE</td> <td>1</td> <td>PZ</td> </tr> <tr> <td>VM2349A0</td> <td>VENTURI LOWER BUSHING</td> <td>1</td> <td>PZ</td> </tr> </tbody> </table>	Code	Description	Qty	UOM	GN1556A0	MM VENTURI SEAL	1	PZ	RC1378A0	HOSE CLAMP	3	PZ	TB1520A0	INT. Ø=38 TH=4 DRAIN BLACK RUBBER PIPE	0.170	M	VE1135A0	220 V 50/60 HZ VENTURI ACTUATOR	1	PZ	VI1032A0	SCREW M4X16 TCB+ INOX	1	PZ	VI1220A1	4,2X12 TCB SELF-TAPPIN G SCREW	6	PZ	VM2345A0	MM VENTURI UPPER HALF	1	PZ	VM2346A0	MM VENTURI LOWER HALF	1	PZ	VM2347A0	MIND.MAPS VENTURI COVER	1	PZ	VM2348A0	VENTURI PLATE SPACE	1	PZ	VM2349A0	VENTURI LOWER BUSHING	1	PZ
Code	Description	Qty	UOM																																																		
GN1556A0	MM VENTURI SEAL	1	PZ																																																		
RC1378A0	HOSE CLAMP	3	PZ																																																		
TB1520A0	INT. Ø=38 TH=4 DRAIN BLACK RUBBER PIPE	0.170	M																																																		
VE1135A0	220 V 50/60 HZ VENTURI ACTUATOR	1	PZ																																																		
VI1032A0	SCREW M4X16 TCB+ INOX	1	PZ																																																		
VI1220A1	4,2X12 TCB SELF-TAPPIN G SCREW	6	PZ																																																		
VM2345A0	MM VENTURI UPPER HALF	1	PZ																																																		
VM2346A0	MM VENTURI LOWER HALF	1	PZ																																																		
VM2347A0	MIND.MAPS VENTURI COVER	1	PZ																																																		
VM2348A0	VENTURI PLATE SPACE	1	PZ																																																		
VM2349A0	VENTURI LOWER BUSHING	1	PZ																																																		
GN1584A	CORNER FITTING D30-D16		KG1584A	D30-D16 CORNER FITTING KIT	<table border="1"> <thead> <tr> <th>Code</th> <th>Description</th> <th>Qty</th> <th>UOM</th> </tr> </thead> <tbody> <tr> <td>GN1584A0</td> <td>CORNER FITTING D30-D16</td> <td>1</td> <td>PZ</td> </tr> </tbody> </table>	Code	Description	Qty	UOM	GN1584A0	CORNER FITTING D30-D16	1	PZ																																								
Code	Description	Qty	UOM																																																		
GN1584A0	CORNER FITTING D30-D16	1	PZ																																																		
TB2603A	TB1520A0- VENTURI FAN 0,12M		KTB2603A	VENTURI-COOLING FAN CONNECT. KIT TB1520A	<table border="1"> <thead> <tr> <th>Code</th> <th>Description</th> <th>Qty</th> <th>UOM</th> </tr> </thead> <tbody> <tr> <td>TB1520A0</td> <td>INT. Ø=38 TH=4 DRAIN BLACK RUBBER PIPE</td> <td>0.120</td> <td>M</td> </tr> </tbody> </table>	Code	Description	Qty	UOM	TB1520A0	INT. Ø=38 TH=4 DRAIN BLACK RUBBER PIPE	0.120	M																																								
Code	Description	Qty	UOM																																																		
TB1520A0	INT. Ø=38 TH=4 DRAIN BLACK RUBBER PIPE	0.120	M																																																		

COMPONENT			SPARE PART																																																										
Code	Description	Image	Code	Description	Components list																																																								
TB1956A	TB1520A-GREY SILICONE PIPE L=0,04M		KVE1135A	SERIES 5/5E VENTURI KIT	<table border="1"> <thead> <tr> <th>Code</th> <th>Description</th> <th>Qty</th> <th>UOM</th> </tr> </thead> <tbody> <tr> <td>GN1310A0</td> <td>VENTURI PIPE SEAL</td> <td>1</td> <td>PZ</td> </tr> <tr> <td>GN1556A0</td> <td>MM VENTURI SEAL</td> <td>1</td> <td>PZ</td> </tr> <tr> <td>RC1378A0</td> <td>HOSE CLAMP</td> <td>2</td> <td>PZ</td> </tr> <tr> <td>TB1520A0</td> <td>INT. Ø=38 TH=4 DRAIN BLACK RUBBER PIPE</td> <td>0.050</td> <td>M</td> </tr> <tr> <td>VE1135A0</td> <td>220 V 50/60 HZ VENTURI ACTUATOR</td> <td>1</td> <td>PZ</td> </tr> <tr> <td>VI1032A0</td> <td>SCREW M4X16 TCB+ INOX</td> <td>1</td> <td>PZ</td> </tr> <tr> <td>VI1511A0</td> <td>STAINLESS STEEL WASHER 4.2X12X1</td> <td>2</td> <td>PZ</td> </tr> <tr> <td>VI1850A0</td> <td>M4X6 NICKEL PLATED FIXING SCRE</td> <td>2</td> <td>PZ</td> </tr> <tr> <td>VI1865A0</td> <td>5X10 TCB+ SELF-THREADI NG SCREW</td> <td>3</td> <td>PZ</td> </tr> <tr> <td>VM1565B0</td> <td>VENTURI LOWER COIL SUPPORT</td> <td>1</td> <td>PZ</td> </tr> <tr> <td>VM1566A0</td> <td>VENTURI UPPER COIL SUPPORT</td> <td>1</td> <td>PZ</td> </tr> <tr> <td>VM1567A0</td> <td>VENTURI LOWER BUSHING</td> <td>1</td> <td>PZ</td> </tr> <tr> <td>VM1568A0</td> <td>VENTURI PLATE SPACE</td> <td>1</td> <td>PZ</td> </tr> </tbody> </table>	Code	Description	Qty	UOM	GN1310A0	VENTURI PIPE SEAL	1	PZ	GN1556A0	MM VENTURI SEAL	1	PZ	RC1378A0	HOSE CLAMP	2	PZ	TB1520A0	INT. Ø=38 TH=4 DRAIN BLACK RUBBER PIPE	0.050	M	VE1135A0	220 V 50/60 HZ VENTURI ACTUATOR	1	PZ	VI1032A0	SCREW M4X16 TCB+ INOX	1	PZ	VI1511A0	STAINLESS STEEL WASHER 4.2X12X1	2	PZ	VI1850A0	M4X6 NICKEL PLATED FIXING SCRE	2	PZ	VI1865A0	5X10 TCB+ SELF-THREADI NG SCREW	3	PZ	VM1565B0	VENTURI LOWER COIL SUPPORT	1	PZ	VM1566A0	VENTURI UPPER COIL SUPPORT	1	PZ	VM1567A0	VENTURI LOWER BUSHING	1	PZ	VM1568A0	VENTURI PLATE SPACE	1	PZ
					Code	Description	Qty	UOM																																																					
					GN1310A0	VENTURI PIPE SEAL	1	PZ																																																					
					GN1556A0	MM VENTURI SEAL	1	PZ																																																					
					RC1378A0	HOSE CLAMP	2	PZ																																																					
					TB1520A0	INT. Ø=38 TH=4 DRAIN BLACK RUBBER PIPE	0.050	M																																																					
					VE1135A0	220 V 50/60 HZ VENTURI ACTUATOR	1	PZ																																																					
					VI1032A0	SCREW M4X16 TCB+ INOX	1	PZ																																																					
					VI1511A0	STAINLESS STEEL WASHER 4.2X12X1	2	PZ																																																					
					VI1850A0	M4X6 NICKEL PLATED FIXING SCRE	2	PZ																																																					
					VI1865A0	5X10 TCB+ SELF-THREADI NG SCREW	3	PZ																																																					
					VM1565B0	VENTURI LOWER COIL SUPPORT	1	PZ																																																					
					VM1566A0	VENTURI UPPER COIL SUPPORT	1	PZ																																																					
					VM1567A0	VENTURI LOWER BUSHING	1	PZ																																																					
					VM1568A0	VENTURI PLATE SPACE	1	PZ																																																					
KTB1002A	BLACK TUBE KIT EPDM 60MT TB1520	<table border="1"> <thead> <tr> <th>Code</th> <th>Description</th> <th>Qty</th> <th>UOM</th> </tr> </thead> <tbody> <tr> <td>IL1206C0</td> <td>968X1053 H126 XBC WOOD PALLE</td> <td>1</td> <td>PZ</td> </tr> <tr> <td>TB1520A0</td> <td>INT. Ø=38 TH=4 DRAIN BLACK RUBBER PIPE</td> <td>60</td> <td>M</td> </tr> </tbody> </table>	Code	Description	Qty	UOM	IL1206C0	968X1053 H126 XBC WOOD PALLE	1	PZ	TB1520A0	INT. Ø=38 TH=4 DRAIN BLACK RUBBER PIPE	60	M																																															
		Code	Description	Qty	UOM																																																								
IL1206C0	968X1053 H126 XBC WOOD PALLE	1	PZ																																																										
TB1520A0	INT. Ø=38 TH=4 DRAIN BLACK RUBBER PIPE	60	M																																																										
KTB1001A	BLACK TUBE KIT EPDM 10MT TB1520	<table border="1"> <thead> <tr> <th>Code</th> <th>Description</th> <th>Qty</th> <th>UOM</th> </tr> </thead> <tbody> <tr> <td>TB1520A0</td> <td>INT. Ø=38 TH=4 DRAIN BLACK RUBBER PIPE</td> <td>10</td> <td>M</td> </tr> <tr> <td>VM1794A0</td> <td>250X4.8 PA66 BLACK CLAMP</td> <td>3</td> <td>PZ</td> </tr> </tbody> </table>	Code	Description	Qty	UOM	TB1520A0	INT. Ø=38 TH=4 DRAIN BLACK RUBBER PIPE	10	M	VM1794A0	250X4.8 PA66 BLACK CLAMP	3	PZ																																															
		Code	Description	Qty	UOM																																																								
TB1520A0	INT. Ø=38 TH=4 DRAIN BLACK RUBBER PIPE	10	M																																																										
VM1794A0	250X4.8 PA66 BLACK CLAMP	3	PZ																																																										

COMPONENT			SPARE PART																										
Code	Description	Image	Code	Description	Components list																								
TB1956A	TB1520A-GREY SILICONE PIPE L=0,04M		KTB1000A	BLACK TUBE KIT EPDM 2MT TB1520A	<table border="1"> <thead> <tr> <th>Code</th> <th>Description</th> <th>Qty</th> <th>UOM</th> </tr> </thead> <tbody> <tr> <td>RC1055A0</td> <td>Ø25-40 H12 STAINLESS STEEL PIPE CLIP</td> <td>2</td> <td>PZ</td> </tr> <tr> <td>TB1520A0</td> <td>INT. Ø=38 TH=4 DRAIN BLACK RUBBER PIPE</td> <td>2</td> <td>M</td> </tr> <tr> <td>VM1059A1</td> <td>HEAT SHRINK FILM H800</td> <td>0.500</td> <td>M</td> </tr> </tbody> </table>	Code	Description	Qty	UOM	RC1055A0	Ø25-40 H12 STAINLESS STEEL PIPE CLIP	2	PZ	TB1520A0	INT. Ø=38 TH=4 DRAIN BLACK RUBBER PIPE	2	M	VM1059A1	HEAT SHRINK FILM H800	0.500	M								
					Code	Description	Qty	UOM																					
RC1055A0	Ø25-40 H12 STAINLESS STEEL PIPE CLIP	2	PZ																										
TB1520A0	INT. Ø=38 TH=4 DRAIN BLACK RUBBER PIPE	2	M																										
VM1059A1	HEAT SHRINK FILM H800	0.500	M																										
RC1042A	DOUBLE WIRE SPRING CLAMP D21.5-22.6		RC1042A0	DOUBLE WIRE SPRING CLAMP D21.5-22.6																									
TB3068B	XEBC-10 VENTURI AIR COLLECTOR PIPE D30		KTB3068B	10FS/EU/2-G VENTURI COLLECTOR PIPE KI	<table border="1"> <thead> <tr> <th>Code</th> <th>Description</th> <th>Qty</th> <th>UOM</th> </tr> </thead> <tbody> <tr> <td>GN1544A0</td> <td>AIR INLET GASKET</td> <td>2</td> <td>PZ</td> </tr> <tr> <td>GN1584A0</td> <td>CORNER FITTING D30-D16</td> <td>1</td> <td>PZ</td> </tr> <tr> <td>RC1042A0</td> <td>DOUBLE WIRE SPRING CLAMP D21.5-22.6</td> <td>1</td> <td>PZ</td> </tr> <tr> <td>TB3068B0</td> <td>XEBC-10 VENTURI AIR COLLECTOR PIPE D30</td> <td>1</td> <td>PZ</td> </tr> <tr> <td>VM1794A0</td> <td>250X4.8 PA66 BLACK CLAMP</td> <td>1</td> <td>PZ</td> </tr> </tbody> </table>	Code	Description	Qty	UOM	GN1544A0	AIR INLET GASKET	2	PZ	GN1584A0	CORNER FITTING D30-D16	1	PZ	RC1042A0	DOUBLE WIRE SPRING CLAMP D21.5-22.6	1	PZ	TB3068B0	XEBC-10 VENTURI AIR COLLECTOR PIPE D30	1	PZ	VM1794A0	250X4.8 PA66 BLACK CLAMP	1	PZ
					Code	Description	Qty	UOM																					
GN1544A0	AIR INLET GASKET	2	PZ																										
GN1584A0	CORNER FITTING D30-D16	1	PZ																										
RC1042A0	DOUBLE WIRE SPRING CLAMP D21.5-22.6	1	PZ																										
TB3068B0	XEBC-10 VENTURI AIR COLLECTOR PIPE D30	1	PZ																										
VM1794A0	250X4.8 PA66 BLACK CLAMP	1	PZ																										
0H7741A	HEAT EXCH TIE ROD ANTI ROTATION PLATE		0H7741A1	HEAT EXCH TIE ROD ANTI ROTATION PLATE																									





COMPONENT			SPARE PART																																																		
Code	Description	Image	Code	Description	Components list																																																
VG1023B			VG1023B0																																																		
GN1541A	BLOWER-SUPPORT CABLE		KG1569A	GAS TORCH SEALINGS KIT	<table border="1"> <thead> <tr> <th>Code</th> <th>Description</th> <th>Qty</th> <th>UOM</th> </tr> </thead> <tbody> <tr> <td>GN1541A0</td> <td>BLOWER-SUP PORT CABLE</td> <td>2</td> <td>PZ</td> </tr> <tr> <td>GN1542A0</td> <td>GAS PIPE'S GASKET 1"</td> <td>4</td> <td>PZ</td> </tr> <tr> <td>GN1543A0</td> <td>PLUG'S GASKET</td> <td>6</td> <td>PZ</td> </tr> <tr> <td>GN1548A0</td> <td>3/4" GAS PIPE ALLUMINIUM WASHER</td> <td>4</td> <td>PZ</td> </tr> <tr> <td>GN1551A1</td> <td>TORCH-CONV EYOR SEALIN</td> <td>2</td> <td>PZ</td> </tr> <tr> <td>GN1551A2</td> <td>TORCH-CHAM BER SEALING</td> <td>2</td> <td>PZ</td> </tr> <tr> <td>GN1559A0</td> <td>O-RING NBR CODE 2087</td> <td>2</td> <td>PZ</td> </tr> <tr> <td>GN1580A1</td> <td>GAS PIPE SCREW COPPER WASHER</td> <td>6</td> <td>PZ</td> </tr> <tr> <td>GN1586A1</td> <td>TORCH PLATE SEALING</td> <td>2</td> <td>PZ</td> </tr> <tr> <td>GN1586A2</td> <td>TORCH LOWER SEALING</td> <td>2</td> <td>PZ</td> </tr> <tr> <td>VI1521A0</td> <td>STAINLESS STEEL WASHER D=6 6592</td> <td>6</td> <td>PZ</td> </tr> </tbody> </table>	Code	Description	Qty	UOM	GN1541A0	BLOWER-SUP PORT CABLE	2	PZ	GN1542A0	GAS PIPE'S GASKET 1"	4	PZ	GN1543A0	PLUG'S GASKET	6	PZ	GN1548A0	3/4" GAS PIPE ALLUMINIUM WASHER	4	PZ	GN1551A1	TORCH-CONV EYOR SEALIN	2	PZ	GN1551A2	TORCH-CHAM BER SEALING	2	PZ	GN1559A0	O-RING NBR CODE 2087	2	PZ	GN1580A1	GAS PIPE SCREW COPPER WASHER	6	PZ	GN1586A1	TORCH PLATE SEALING	2	PZ	GN1586A2	TORCH LOWER SEALING	2	PZ	VI1521A0	STAINLESS STEEL WASHER D=6 6592	6	PZ
Code	Description	Qty	UOM																																																		
GN1541A0	BLOWER-SUP PORT CABLE	2	PZ																																																		
GN1542A0	GAS PIPE'S GASKET 1"	4	PZ																																																		
GN1543A0	PLUG'S GASKET	6	PZ																																																		
GN1548A0	3/4" GAS PIPE ALLUMINIUM WASHER	4	PZ																																																		
GN1551A1	TORCH-CONV EYOR SEALIN	2	PZ																																																		
GN1551A2	TORCH-CHAM BER SEALING	2	PZ																																																		
GN1559A0	O-RING NBR CODE 2087	2	PZ																																																		
GN1580A1	GAS PIPE SCREW COPPER WASHER	6	PZ																																																		
GN1586A1	TORCH PLATE SEALING	2	PZ																																																		
GN1586A2	TORCH LOWER SEALING	2	PZ																																																		
VI1521A0	STAINLESS STEEL WASHER D=6 6592	6	PZ																																																		
VG1014A	230V 35KW MAX VENTURI-BLOWING GROUP		KVG1014A	230V 35KW MAX VENTURI-PREMIX BLOWER KIT	<table border="1"> <thead> <tr> <th>Code</th> <th>Description</th> <th>Qty</th> <th>UOM</th> </tr> </thead> <tbody> <tr> <td>0N1415A0</td> <td>BLOWER CONNECTION PLATE</td> <td>1</td> <td>PZ</td> </tr> <tr> <td>GN1541A0</td> <td>BLOWER-SUP PORT CABLE</td> <td>1</td> <td>PZ</td> </tr> <tr> <td>IP1385A1</td> <td>CORNER POLYSTYREN E PACKING 110X80X2000</td> <td>0.240</td> <td>M</td> </tr> <tr> <td>VG1014A0</td> <td>230V 35KW MAX VENTURI-BLOWING GROUP</td> <td>1</td> <td>PZ</td> </tr> </tbody> </table>	Code	Description	Qty	UOM	0N1415A0	BLOWER CONNECTION PLATE	1	PZ	GN1541A0	BLOWER-SUP PORT CABLE	1	PZ	IP1385A1	CORNER POLYSTYREN E PACKING 110X80X2000	0.240	M	VG1014A0	230V 35KW MAX VENTURI-BLOWING GROUP	1	PZ																												
Code	Description	Qty	UOM																																																		
0N1415A0	BLOWER CONNECTION PLATE	1	PZ																																																		
GN1541A0	BLOWER-SUP PORT CABLE	1	PZ																																																		
IP1385A1	CORNER POLYSTYREN E PACKING 110X80X2000	0.240	M																																																		
VG1014A0	230V 35KW MAX VENTURI-BLOWING GROUP	1	PZ																																																		

COMPONENT			SPARE PART																						
Code	Description	Image	Code	Description	Components list																				
VG1014A	230V 35KW MAX VENTURI-BLOWING GROUP		KVG1014A	230V 35KW MAX VENTURI-PREMIX BLOWER KIT	<table border="1"> <thead> <tr> <th>Code</th> <th>Description</th> <th>Qty</th> <th>UOM</th> </tr> </thead> <tbody> <tr> <td>VI1770A0</td> <td>STAINLESS STEEL NUT M5 H=5 CH=8</td> <td>3</td> <td>PZ</td> </tr> <tr> <td>VI2008A0</td> <td>ZINCED NOTCHED M5 WASHER</td> <td>3</td> <td>PZ</td> </tr> <tr> <td>VI2008A1</td> <td>ST STEEL NOTCHED M5 WASHER</td> <td>4</td> <td>PZ</td> </tr> <tr> <td>VI2021A0</td> <td>M5X0.8 H5 CH 8 BRASS NUT</td> <td>4</td> <td>PZ</td> </tr> </tbody> </table>	Code	Description	Qty	UOM	VI1770A0	STAINLESS STEEL NUT M5 H=5 CH=8	3	PZ	VI2008A0	ZINCED NOTCHED M5 WASHER	3	PZ	VI2008A1	ST STEEL NOTCHED M5 WASHER	4	PZ	VI2021A0	M5X0.8 H5 CH 8 BRASS NUT	4	PZ
Code	Description	Qty	UOM																						
VI1770A0	STAINLESS STEEL NUT M5 H=5 CH=8	3	PZ																						
VI2008A0	ZINCED NOTCHED M5 WASHER	3	PZ																						
VI2008A1	ST STEEL NOTCHED M5 WASHER	4	PZ																						
VI2021A0	M5X0.8 H5 CH 8 BRASS NUT	4	PZ																						
VG1012A			VG1012A0																						
VG1010A			VG1010A0																						
VN1168A			VN1168A0																						
RC1394A	FLEXIBLE REVOLVING 3/4 GAS F-F FITTING		KRC1394A	FLEXIBLE 3/4 GAS CONNECTION KIT	<table border="1"> <thead> <tr> <th>Code</th> <th>Description</th> <th>Qty</th> <th>UOM</th> </tr> </thead> <tbody> <tr> <td>GN1548A0</td> <td>3/4" GAS PIPE ALLUMINIUM WASHER</td> <td>2</td> <td>PZ</td> </tr> <tr> <td>RC1394A0</td> <td>FLEXIBLE REVOLVING 3/4 GAS F-F FITTING</td> <td>1</td> <td>PZ</td> </tr> <tr> <td>VM1794A0</td> <td>250X4.8 PA66 BLACK CLAMP</td> <td>2</td> <td>PZ</td> </tr> <tr> <td>VM2103A0</td> <td>CLAMP LOCK</td> <td>2</td> <td>PZ</td> </tr> </tbody> </table>	Code	Description	Qty	UOM	GN1548A0	3/4" GAS PIPE ALLUMINIUM WASHER	2	PZ	RC1394A0	FLEXIBLE REVOLVING 3/4 GAS F-F FITTING	1	PZ	VM1794A0	250X4.8 PA66 BLACK CLAMP	2	PZ	VM2103A0	CLAMP LOCK	2	PZ
Code	Description	Qty	UOM																						
GN1548A0	3/4" GAS PIPE ALLUMINIUM WASHER	2	PZ																						
RC1394A0	FLEXIBLE REVOLVING 3/4 GAS F-F FITTING	1	PZ																						
VM1794A0	250X4.8 PA66 BLACK CLAMP	2	PZ																						
VM2103A0	CLAMP LOCK	2	PZ																						







COMPONENT			SPARE PART																																																		
Code	Description	Image	Code	Description	Components list																																																
0N1415A	BLOWER CONNECTION PLAT		0N1415A0	BLOWER CONNECTION PLAT																																																	
GN1548A	3/4" GAS PIPE ALLUMINIUM WASHER		KG1569A	GAS TORCH SEALINGS KIT	<table border="1"> <thead> <tr> <th>Code</th> <th>Description</th> <th>Qty</th> <th>UOM</th> </tr> </thead> <tbody> <tr> <td>GN1541A0</td> <td>BLOWER-SUP PORT CABLE</td> <td>2</td> <td>PZ</td> </tr> <tr> <td>GN1542A0</td> <td>GAS PIPE'S GASKET 1"</td> <td>4</td> <td>PZ</td> </tr> <tr> <td>GN1543A0</td> <td>PLUG'S GASKET</td> <td>6</td> <td>PZ</td> </tr> <tr> <td>GN1548A0</td> <td>3/4" GAS PIPE ALLUMINIUM WASHER</td> <td>4</td> <td>PZ</td> </tr> <tr> <td>GN1551A1</td> <td>TORCH-CONV EYOR SEALIN</td> <td>2</td> <td>PZ</td> </tr> <tr> <td>GN1551A2</td> <td>TORCH-CHAM BER SEALING</td> <td>2</td> <td>PZ</td> </tr> <tr> <td>GN1559A0</td> <td>O-RING NBR CODE 2087</td> <td>2</td> <td>PZ</td> </tr> <tr> <td>GN1580A1</td> <td>GAS PIPE SCREW COPPER WASHER</td> <td>6</td> <td>PZ</td> </tr> <tr> <td>GN1586A1</td> <td>TORCH PLATE SEALING</td> <td>2</td> <td>PZ</td> </tr> <tr> <td>GN1586A2</td> <td>TORCH LOWER SEALING</td> <td>2</td> <td>PZ</td> </tr> <tr> <td>VI1521A0</td> <td>STAINLESS STEEL WASHER D=6 6592</td> <td>6</td> <td>PZ</td> </tr> </tbody> </table>	Code	Description	Qty	UOM	GN1541A0	BLOWER-SUP PORT CABLE	2	PZ	GN1542A0	GAS PIPE'S GASKET 1"	4	PZ	GN1543A0	PLUG'S GASKET	6	PZ	GN1548A0	3/4" GAS PIPE ALLUMINIUM WASHER	4	PZ	GN1551A1	TORCH-CONV EYOR SEALIN	2	PZ	GN1551A2	TORCH-CHAM BER SEALING	2	PZ	GN1559A0	O-RING NBR CODE 2087	2	PZ	GN1580A1	GAS PIPE SCREW COPPER WASHER	6	PZ	GN1586A1	TORCH PLATE SEALING	2	PZ	GN1586A2	TORCH LOWER SEALING	2	PZ	VI1521A0	STAINLESS STEEL WASHER D=6 6592	6	PZ
Code	Description	Qty	UOM																																																		
GN1541A0	BLOWER-SUP PORT CABLE	2	PZ																																																		
GN1542A0	GAS PIPE'S GASKET 1"	4	PZ																																																		
GN1543A0	PLUG'S GASKET	6	PZ																																																		
GN1548A0	3/4" GAS PIPE ALLUMINIUM WASHER	4	PZ																																																		
GN1551A1	TORCH-CONV EYOR SEALIN	2	PZ																																																		
GN1551A2	TORCH-CHAM BER SEALING	2	PZ																																																		
GN1559A0	O-RING NBR CODE 2087	2	PZ																																																		
GN1580A1	GAS PIPE SCREW COPPER WASHER	6	PZ																																																		
GN1586A1	TORCH PLATE SEALING	2	PZ																																																		
GN1586A2	TORCH LOWER SEALING	2	PZ																																																		
VI1521A0	STAINLESS STEEL WASHER D=6 6592	6	PZ																																																		
VM2388A	T FITTING Ø30X1																																																				



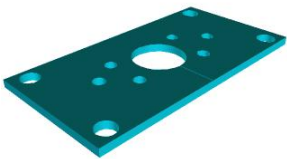

COMPONENT			SPARE PART																																																		
Code	Description	Image	Code	Description	Components list																																																
VI2021A	M5X0.8 H5 CH 8 BRASS NUT		VI2021A0	M5X0.8 H5 CH 8 BRASS NUT																																																	
GN1551A	TORCH-CHAMBER SEALING		KGN1569A	GAS TORCH SEALINGS KIT	<table border="1"> <thead> <tr> <th>Code</th> <th>Description</th> <th>Qty</th> <th>UOM</th> </tr> </thead> <tbody> <tr> <td>GN1541A0</td> <td>BLOWER-SUP PORT CABLE</td> <td>2</td> <td>PZ</td> </tr> <tr> <td>GN1542A0</td> <td>GAS PIPE'S GASKET 1"</td> <td>4</td> <td>PZ</td> </tr> <tr> <td>GN1543A0</td> <td>PLUG'S GASKET</td> <td>6</td> <td>PZ</td> </tr> <tr> <td>GN1548A0</td> <td>3/4" GAS PIPE ALLUMINIUM WASHER</td> <td>4</td> <td>PZ</td> </tr> <tr> <td>GN1551A1</td> <td>TORCH-CONV EYOR SEALIN</td> <td>2</td> <td>PZ</td> </tr> <tr> <td>GN1551A2</td> <td>TORCH-CHAM BER SEALING</td> <td>2</td> <td>PZ</td> </tr> <tr> <td>GN1559A0</td> <td>O-RING NBR CODE 2087</td> <td>2</td> <td>PZ</td> </tr> <tr> <td>GN1580A1</td> <td>GAS PIPE SCREW COPPER WASHER</td> <td>6</td> <td>PZ</td> </tr> <tr> <td>GN1586A1</td> <td>TORCH PLATE SEALING</td> <td>2</td> <td>PZ</td> </tr> <tr> <td>GN1586A2</td> <td>TORCH LOWER SEALING</td> <td>2</td> <td>PZ</td> </tr> <tr> <td>VI1521A0</td> <td>STAINLESS STEEL WASHER D=6 6592</td> <td>6</td> <td>PZ</td> </tr> </tbody> </table>	Code	Description	Qty	UOM	GN1541A0	BLOWER-SUP PORT CABLE	2	PZ	GN1542A0	GAS PIPE'S GASKET 1"	4	PZ	GN1543A0	PLUG'S GASKET	6	PZ	GN1548A0	3/4" GAS PIPE ALLUMINIUM WASHER	4	PZ	GN1551A1	TORCH-CONV EYOR SEALIN	2	PZ	GN1551A2	TORCH-CHAM BER SEALING	2	PZ	GN1559A0	O-RING NBR CODE 2087	2	PZ	GN1580A1	GAS PIPE SCREW COPPER WASHER	6	PZ	GN1586A1	TORCH PLATE SEALING	2	PZ	GN1586A2	TORCH LOWER SEALING	2	PZ	VI1521A0	STAINLESS STEEL WASHER D=6 6592	6	PZ
Code	Description	Qty	UOM																																																		
GN1541A0	BLOWER-SUP PORT CABLE	2	PZ																																																		
GN1542A0	GAS PIPE'S GASKET 1"	4	PZ																																																		
GN1543A0	PLUG'S GASKET	6	PZ																																																		
GN1548A0	3/4" GAS PIPE ALLUMINIUM WASHER	4	PZ																																																		
GN1551A1	TORCH-CONV EYOR SEALIN	2	PZ																																																		
GN1551A2	TORCH-CHAM BER SEALING	2	PZ																																																		
GN1559A0	O-RING NBR CODE 2087	2	PZ																																																		
GN1580A1	GAS PIPE SCREW COPPER WASHER	6	PZ																																																		
GN1586A1	TORCH PLATE SEALING	2	PZ																																																		
GN1586A2	TORCH LOWER SEALING	2	PZ																																																		
VI1521A0	STAINLESS STEEL WASHER D=6 6592	6	PZ																																																		
GN1542A	GAS PIPE'S GASKET 1"		KGN1569A	GAS TORCH SEALINGS KIT	<table border="1"> <thead> <tr> <th>Code</th> <th>Description</th> <th>Qty</th> <th>UOM</th> </tr> </thead> <tbody> <tr> <td>GN1541A0</td> <td>BLOWER-SUP PORT CABLE</td> <td>2</td> <td>PZ</td> </tr> <tr> <td>GN1542A0</td> <td>GAS PIPE'S GASKET 1"</td> <td>4</td> <td>PZ</td> </tr> <tr> <td>GN1543A0</td> <td>PLUG'S GASKET</td> <td>6</td> <td>PZ</td> </tr> <tr> <td>GN1548A0</td> <td>3/4" GAS PIPE ALLUMINIUM WASHER</td> <td>4</td> <td>PZ</td> </tr> <tr> <td>GN1551A1</td> <td>TORCH-CONV EYOR SEALIN</td> <td>2</td> <td>PZ</td> </tr> <tr> <td>GN1551A2</td> <td>TORCH-CHAM BER SEALING</td> <td>2</td> <td>PZ</td> </tr> <tr> <td>GN1559A0</td> <td>O-RING NBR CODE 2087</td> <td>2</td> <td>PZ</td> </tr> </tbody> </table>	Code	Description	Qty	UOM	GN1541A0	BLOWER-SUP PORT CABLE	2	PZ	GN1542A0	GAS PIPE'S GASKET 1"	4	PZ	GN1543A0	PLUG'S GASKET	6	PZ	GN1548A0	3/4" GAS PIPE ALLUMINIUM WASHER	4	PZ	GN1551A1	TORCH-CONV EYOR SEALIN	2	PZ	GN1551A2	TORCH-CHAM BER SEALING	2	PZ	GN1559A0	O-RING NBR CODE 2087	2	PZ																
Code	Description	Qty	UOM																																																		
GN1541A0	BLOWER-SUP PORT CABLE	2	PZ																																																		
GN1542A0	GAS PIPE'S GASKET 1"	4	PZ																																																		
GN1543A0	PLUG'S GASKET	6	PZ																																																		
GN1548A0	3/4" GAS PIPE ALLUMINIUM WASHER	4	PZ																																																		
GN1551A1	TORCH-CONV EYOR SEALIN	2	PZ																																																		
GN1551A2	TORCH-CHAM BER SEALING	2	PZ																																																		
GN1559A0	O-RING NBR CODE 2087	2	PZ																																																		

COMPONENT			SPARE PART																																																		
Code	Description	Image	Code	Description	Components list																																																
GN1542A	GAS PIPE'S GASKET 1"		KGN1569A	GAS TORCH SEALINGS KIT	<table border="1"> <thead> <tr> <th>Code</th> <th>Description</th> <th>Qty</th> <th>UOM</th> </tr> </thead> <tbody> <tr> <td>GN1580A1</td> <td>GAS PIPE SCREW COPPER WASHER</td> <td>6</td> <td>PZ</td> </tr> <tr> <td>GN1586A1</td> <td>TORCH PLATE SEALING</td> <td>2</td> <td>PZ</td> </tr> <tr> <td>GN1586A2</td> <td>TORCH LOWER SEALING</td> <td>2</td> <td>PZ</td> </tr> <tr> <td>VI1521A0</td> <td>STAINLESS STEEL WASHER D=6 6592</td> <td>6</td> <td>PZ</td> </tr> </tbody> </table>	Code	Description	Qty	UOM	GN1580A1	GAS PIPE SCREW COPPER WASHER	6	PZ	GN1586A1	TORCH PLATE SEALING	2	PZ	GN1586A2	TORCH LOWER SEALING	2	PZ	VI1521A0	STAINLESS STEEL WASHER D=6 6592	6	PZ																												
Code	Description	Qty	UOM																																																		
GN1580A1	GAS PIPE SCREW COPPER WASHER	6	PZ																																																		
GN1586A1	TORCH PLATE SEALING	2	PZ																																																		
GN1586A2	TORCH LOWER SEALING	2	PZ																																																		
VI1521A0	STAINLESS STEEL WASHER D=6 6592	6	PZ																																																		
ON1383B	COMPLETE RAMP BLOWER		KON1383B	GAS BLOWING RAMP KIT	<table border="1"> <thead> <tr> <th>Code</th> <th>Description</th> <th>Qty</th> <th>UOM</th> </tr> </thead> <tbody> <tr> <td>ON1383B0</td> <td>COMPLETE RAMP BLOWE</td> <td>1</td> <td>PZ</td> </tr> <tr> <td>GN1541A0</td> <td>BLOWER-SUP PORT CABLE</td> <td>1</td> <td>PZ</td> </tr> <tr> <td>GN1542A0</td> <td>GAS PIPE'S GASKET 1"</td> <td>2</td> <td>PZ</td> </tr> <tr> <td>VI1310A0</td> <td>ZINC THREAD INSERT M6 FTR/E</td> <td>4</td> <td>PZ</td> </tr> </tbody> </table>	Code	Description	Qty	UOM	ON1383B0	COMPLETE RAMP BLOWE	1	PZ	GN1541A0	BLOWER-SUP PORT CABLE	1	PZ	GN1542A0	GAS PIPE'S GASKET 1"	2	PZ	VI1310A0	ZINC THREAD INSERT M6 FTR/E	4	PZ																												
Code	Description	Qty	UOM																																																		
ON1383B0	COMPLETE RAMP BLOWE	1	PZ																																																		
GN1541A0	BLOWER-SUP PORT CABLE	1	PZ																																																		
GN1542A0	GAS PIPE'S GASKET 1"	2	PZ																																																		
VI1310A0	ZINC THREAD INSERT M6 FTR/E	4	PZ																																																		
GN1543A	PLUG'S GASKET		KGN1569A	GAS TORCH SEALINGS KIT	<table border="1"> <thead> <tr> <th>Code</th> <th>Description</th> <th>Qty</th> <th>UOM</th> </tr> </thead> <tbody> <tr> <td>GN1541A0</td> <td>BLOWER-SUP PORT CABLE</td> <td>2</td> <td>PZ</td> </tr> <tr> <td>GN1542A0</td> <td>GAS PIPE'S GASKET 1"</td> <td>4</td> <td>PZ</td> </tr> <tr> <td>GN1543A0</td> <td>PLUG'S GASKET</td> <td>6</td> <td>PZ</td> </tr> <tr> <td>GN1548A0</td> <td>3/4" GAS PIPE ALLUMINIUM WASHER</td> <td>4</td> <td>PZ</td> </tr> <tr> <td>GN1551A1</td> <td>TORCH-CONV EYOR SEALIN</td> <td>2</td> <td>PZ</td> </tr> <tr> <td>GN1551A2</td> <td>TORCH-CHAM BER SEALING</td> <td>2</td> <td>PZ</td> </tr> <tr> <td>GN1559A0</td> <td>O-RING NBR CODE 2087</td> <td>2</td> <td>PZ</td> </tr> <tr> <td>GN1580A1</td> <td>GAS PIPE SCREW COPPER WASHER</td> <td>6</td> <td>PZ</td> </tr> <tr> <td>GN1586A1</td> <td>TORCH PLATE SEALING</td> <td>2</td> <td>PZ</td> </tr> <tr> <td>GN1586A2</td> <td>TORCH LOWER SEALING</td> <td>2</td> <td>PZ</td> </tr> <tr> <td>VI1521A0</td> <td>STAINLESS STEEL WASHER D=6 6592</td> <td>6</td> <td>PZ</td> </tr> </tbody> </table>	Code	Description	Qty	UOM	GN1541A0	BLOWER-SUP PORT CABLE	2	PZ	GN1542A0	GAS PIPE'S GASKET 1"	4	PZ	GN1543A0	PLUG'S GASKET	6	PZ	GN1548A0	3/4" GAS PIPE ALLUMINIUM WASHER	4	PZ	GN1551A1	TORCH-CONV EYOR SEALIN	2	PZ	GN1551A2	TORCH-CHAM BER SEALING	2	PZ	GN1559A0	O-RING NBR CODE 2087	2	PZ	GN1580A1	GAS PIPE SCREW COPPER WASHER	6	PZ	GN1586A1	TORCH PLATE SEALING	2	PZ	GN1586A2	TORCH LOWER SEALING	2	PZ	VI1521A0	STAINLESS STEEL WASHER D=6 6592	6	PZ
Code	Description	Qty	UOM																																																		
GN1541A0	BLOWER-SUP PORT CABLE	2	PZ																																																		
GN1542A0	GAS PIPE'S GASKET 1"	4	PZ																																																		
GN1543A0	PLUG'S GASKET	6	PZ																																																		
GN1548A0	3/4" GAS PIPE ALLUMINIUM WASHER	4	PZ																																																		
GN1551A1	TORCH-CONV EYOR SEALIN	2	PZ																																																		
GN1551A2	TORCH-CHAM BER SEALING	2	PZ																																																		
GN1559A0	O-RING NBR CODE 2087	2	PZ																																																		
GN1580A1	GAS PIPE SCREW COPPER WASHER	6	PZ																																																		
GN1586A1	TORCH PLATE SEALING	2	PZ																																																		
GN1586A2	TORCH LOWER SEALING	2	PZ																																																		
VI1521A0	STAINLESS STEEL WASHER D=6 6592	6	PZ																																																		

COMPONENT			SPARE PART																																																		
Code	Description	Image	Code	Description	Components list																																																
GN1580A	GAS PIPE SCREW COPPER WASHER		KGN1569A	GAS TORCH SEALINGS KIT	<table border="1"> <thead> <tr> <th>Code</th> <th>Description</th> <th>Qty</th> <th>UOM</th> </tr> </thead> <tbody> <tr> <td>GN1541A0</td> <td>BLOWER-SUP PORT CABLE</td> <td>2</td> <td>PZ</td> </tr> <tr> <td>GN1542A0</td> <td>GAS PIPE'S GASKET 1"</td> <td>4</td> <td>PZ</td> </tr> <tr> <td>GN1543A0</td> <td>PLUG'S GASKET</td> <td>6</td> <td>PZ</td> </tr> <tr> <td>GN1548A0</td> <td>3/4" GAS PIPE ALLUMINIUM WASHER</td> <td>4</td> <td>PZ</td> </tr> <tr> <td>GN1551A1</td> <td>TORCH-CONV EYOR SEALIN</td> <td>2</td> <td>PZ</td> </tr> <tr> <td>GN1551A2</td> <td>TORCH-CHAM BER SEALING</td> <td>2</td> <td>PZ</td> </tr> <tr> <td>GN1559A0</td> <td>O-RING NBR CODE 2087</td> <td>2</td> <td>PZ</td> </tr> <tr> <td>GN1580A1</td> <td>GAS PIPE SCREW COPPER WASHER</td> <td>6</td> <td>PZ</td> </tr> <tr> <td>GN1586A1</td> <td>TORCH PLATE SEALING</td> <td>2</td> <td>PZ</td> </tr> <tr> <td>GN1586A2</td> <td>TORCH LOWER SEALING</td> <td>2</td> <td>PZ</td> </tr> <tr> <td>VI1521A0</td> <td>STAINLESS STEEL WASHER D=6 6592</td> <td>6</td> <td>PZ</td> </tr> </tbody> </table>	Code	Description	Qty	UOM	GN1541A0	BLOWER-SUP PORT CABLE	2	PZ	GN1542A0	GAS PIPE'S GASKET 1"	4	PZ	GN1543A0	PLUG'S GASKET	6	PZ	GN1548A0	3/4" GAS PIPE ALLUMINIUM WASHER	4	PZ	GN1551A1	TORCH-CONV EYOR SEALIN	2	PZ	GN1551A2	TORCH-CHAM BER SEALING	2	PZ	GN1559A0	O-RING NBR CODE 2087	2	PZ	GN1580A1	GAS PIPE SCREW COPPER WASHER	6	PZ	GN1586A1	TORCH PLATE SEALING	2	PZ	GN1586A2	TORCH LOWER SEALING	2	PZ	VI1521A0	STAINLESS STEEL WASHER D=6 6592	6	PZ
					Code	Description	Qty	UOM																																													
GN1541A0	BLOWER-SUP PORT CABLE	2	PZ																																																		
GN1542A0	GAS PIPE'S GASKET 1"	4	PZ																																																		
GN1543A0	PLUG'S GASKET	6	PZ																																																		
GN1548A0	3/4" GAS PIPE ALLUMINIUM WASHER	4	PZ																																																		
GN1551A1	TORCH-CONV EYOR SEALIN	2	PZ																																																		
GN1551A2	TORCH-CHAM BER SEALING	2	PZ																																																		
GN1559A0	O-RING NBR CODE 2087	2	PZ																																																		
GN1580A1	GAS PIPE SCREW COPPER WASHER	6	PZ																																																		
GN1586A1	TORCH PLATE SEALING	2	PZ																																																		
GN1586A2	TORCH LOWER SEALING	2	PZ																																																		
VI1521A0	STAINLESS STEEL WASHER D=6 6592	6	PZ																																																		
VI2020A	M4X1 H4 CH 7 BRASS NUT		VI2020A0	M4X1 H4 CH 7 BRASS NUT																																																	
GN1586A	TORCH LOWER SEALING		KGN1569A	GAS TORCH SEALINGS KIT	<table border="1"> <thead> <tr> <th>Code</th> <th>Description</th> <th>Qty</th> <th>UOM</th> </tr> </thead> <tbody> <tr> <td>GN1541A0</td> <td>BLOWER-SUP PORT CABLE</td> <td>2</td> <td>PZ</td> </tr> <tr> <td>GN1542A0</td> <td>GAS PIPE'S GASKET 1"</td> <td>4</td> <td>PZ</td> </tr> <tr> <td>GN1543A0</td> <td>PLUG'S GASKET</td> <td>6</td> <td>PZ</td> </tr> <tr> <td>GN1548A0</td> <td>3/4" GAS PIPE ALLUMINIUM WASHER</td> <td>4</td> <td>PZ</td> </tr> <tr> <td>GN1551A1</td> <td>TORCH-CONV EYOR SEALIN</td> <td>2</td> <td>PZ</td> </tr> <tr> <td>GN1551A2</td> <td>TORCH-CHAM BER SEALING</td> <td>2</td> <td>PZ</td> </tr> <tr> <td>GN1559A0</td> <td>O-RING NBR CODE 2087</td> <td>2</td> <td>PZ</td> </tr> </tbody> </table>	Code	Description	Qty	UOM	GN1541A0	BLOWER-SUP PORT CABLE	2	PZ	GN1542A0	GAS PIPE'S GASKET 1"	4	PZ	GN1543A0	PLUG'S GASKET	6	PZ	GN1548A0	3/4" GAS PIPE ALLUMINIUM WASHER	4	PZ	GN1551A1	TORCH-CONV EYOR SEALIN	2	PZ	GN1551A2	TORCH-CHAM BER SEALING	2	PZ	GN1559A0	O-RING NBR CODE 2087	2	PZ																
					Code	Description	Qty	UOM																																													
GN1541A0	BLOWER-SUP PORT CABLE	2	PZ																																																		
GN1542A0	GAS PIPE'S GASKET 1"	4	PZ																																																		
GN1543A0	PLUG'S GASKET	6	PZ																																																		
GN1548A0	3/4" GAS PIPE ALLUMINIUM WASHER	4	PZ																																																		
GN1551A1	TORCH-CONV EYOR SEALIN	2	PZ																																																		
GN1551A2	TORCH-CHAM BER SEALING	2	PZ																																																		
GN1559A0	O-RING NBR CODE 2087	2	PZ																																																		

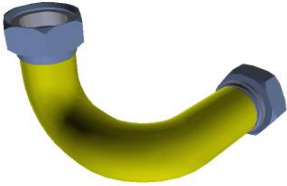
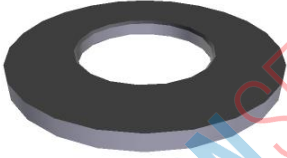
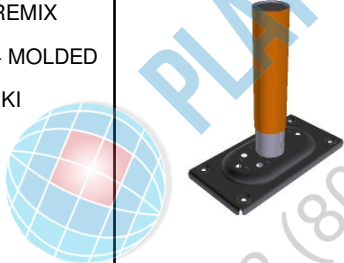
COMPONENT			SPARE PART																																																																		
Code	Description	Image	Code	Description	Components list																																																																
GN1586A	TORCH LOWER SEALING		KG1569A	GAS TORCH SEALINGS KIT	<table border="1"> <thead> <tr> <th>Code</th> <th>Description</th> <th>Qty</th> <th>UOM</th> </tr> </thead> <tbody> <tr> <td>GN1580A1</td> <td>GAS PIPE SCREW COPPER WASHER</td> <td>6</td> <td>PZ</td> </tr> <tr> <td>GN1586A1</td> <td>TORCH PLATE SEALING</td> <td>2</td> <td>PZ</td> </tr> <tr> <td>GN1586A2</td> <td>TORCH LOWER SEALING</td> <td>2</td> <td>PZ</td> </tr> <tr> <td>VI1521A0</td> <td>STAINLESS STEEL WASHER D=6 6592</td> <td>6</td> <td>PZ</td> </tr> </tbody> </table>	Code	Description	Qty	UOM	GN1580A1	GAS PIPE SCREW COPPER WASHER	6	PZ	GN1586A1	TORCH PLATE SEALING	2	PZ	GN1586A2	TORCH LOWER SEALING	2	PZ	VI1521A0	STAINLESS STEEL WASHER D=6 6592	6	PZ																																												
Code	Description	Qty	UOM																																																																		
GN1580A1	GAS PIPE SCREW COPPER WASHER	6	PZ																																																																		
GN1586A1	TORCH PLATE SEALING	2	PZ																																																																		
GN1586A2	TORCH LOWER SEALING	2	PZ																																																																		
VI1521A0	STAINLESS STEEL WASHER D=6 6592	6	PZ																																																																		
BR1340A	PREMIX START-UP CANDLE		KBR1340A	PREMIX BURNER START UP PLUG 6 PCS KIT	<table border="1"> <thead> <tr> <th>Code</th> <th>Description</th> <th>Qty</th> <th>UOM</th> </tr> </thead> <tbody> <tr> <td>BR1340A0</td> <td>PREMIX START-UP CANDLE</td> <td>1</td> <td>PZ</td> </tr> <tr> <td>BR1340A1</td> <td></td> <td>6</td> <td>PZ</td> </tr> <tr> <td>BR1340A2</td> <td>PREMIX START-UP CANDLE</td> <td>6</td> <td>PZ</td> </tr> <tr> <td>GN1541A0</td> <td>BLOWER-SUP PORT CABLE</td> <td>2</td> <td>PZ</td> </tr> <tr> <td>GN1542A0</td> <td>GAS PIPE'S GASKET 1"</td> <td>4</td> <td>PZ</td> </tr> <tr> <td>GN1543A0</td> <td>PLUG'S GASKET</td> <td>1</td> <td>PZ</td> </tr> <tr> <td>GN1548A0</td> <td>3/4" GAS PIPE ALLUMINIUM WASHER</td> <td>4</td> <td>PZ</td> </tr> <tr> <td>GN1551A2</td> <td>TORCH-CHAM BER SEALING</td> <td>2</td> <td>PZ</td> </tr> <tr> <td>GN1559A0</td> <td>O-RING NBR CODE 2087</td> <td>2</td> <td>PZ</td> </tr> <tr> <td>GN1580A1</td> <td>GAS PIPE SCREW COPPER WASHER</td> <td>6</td> <td>PZ</td> </tr> <tr> <td>GN1586A2</td> <td>TORCH LOWER SEALING</td> <td>2</td> <td>PZ</td> </tr> <tr> <td>VI0504A1</td> <td>INOX NOTCHED M4 WASHER</td> <td>12</td> <td>PZ</td> </tr> <tr> <td>VI1075A0</td> <td>NUT M4 H=4 UNI5587 INOX</td> <td>2</td> <td>PZ</td> </tr> <tr> <td>VI1550A0</td> <td>KNURLED WASHER Ø4 INOX SCHNOO</td> <td>2</td> <td>PZ</td> </tr> <tr> <td>VI2020A0</td> <td>M4X1 H4 CH 7 BRASS NUT</td> <td>12</td> <td>PZ</td> </tr> </tbody> </table>	Code	Description	Qty	UOM	BR1340A0	PREMIX START-UP CANDLE	1	PZ	BR1340A1		6	PZ	BR1340A2	PREMIX START-UP CANDLE	6	PZ	GN1541A0	BLOWER-SUP PORT CABLE	2	PZ	GN1542A0	GAS PIPE'S GASKET 1"	4	PZ	GN1543A0	PLUG'S GASKET	1	PZ	GN1548A0	3/4" GAS PIPE ALLUMINIUM WASHER	4	PZ	GN1551A2	TORCH-CHAM BER SEALING	2	PZ	GN1559A0	O-RING NBR CODE 2087	2	PZ	GN1580A1	GAS PIPE SCREW COPPER WASHER	6	PZ	GN1586A2	TORCH LOWER SEALING	2	PZ	VI0504A1	INOX NOTCHED M4 WASHER	12	PZ	VI1075A0	NUT M4 H=4 UNI5587 INOX	2	PZ	VI1550A0	KNURLED WASHER Ø4 INOX SCHNOO	2	PZ	VI2020A0	M4X1 H4 CH 7 BRASS NUT	12	PZ
Code	Description	Qty	UOM																																																																		
BR1340A0	PREMIX START-UP CANDLE	1	PZ																																																																		
BR1340A1		6	PZ																																																																		
BR1340A2	PREMIX START-UP CANDLE	6	PZ																																																																		
GN1541A0	BLOWER-SUP PORT CABLE	2	PZ																																																																		
GN1542A0	GAS PIPE'S GASKET 1"	4	PZ																																																																		
GN1543A0	PLUG'S GASKET	1	PZ																																																																		
GN1548A0	3/4" GAS PIPE ALLUMINIUM WASHER	4	PZ																																																																		
GN1551A2	TORCH-CHAM BER SEALING	2	PZ																																																																		
GN1559A0	O-RING NBR CODE 2087	2	PZ																																																																		
GN1580A1	GAS PIPE SCREW COPPER WASHER	6	PZ																																																																		
GN1586A2	TORCH LOWER SEALING	2	PZ																																																																		
VI0504A1	INOX NOTCHED M4 WASHER	12	PZ																																																																		
VI1075A0	NUT M4 H=4 UNI5587 INOX	2	PZ																																																																		
VI1550A0	KNURLED WASHER Ø4 INOX SCHNOO	2	PZ																																																																		
VI2020A0	M4X1 H4 CH 7 BRASS NUT	12	PZ																																																																		

COMPONENT			SPARE PART																																																		
Code	Description	Image	Code	Description	Components list																																																
RC1385B	FLEXIBLE REVOLVING 1 GAS F-F FITTING		KRC1385B	FLEXIBLE REVOLVING GAS CONNECTION KIT	<table border="1"> <thead> <tr> <th>Code</th> <th>Description</th> <th>Qty</th> <th>UOM</th> </tr> </thead> <tbody> <tr> <td>GN1542A0</td> <td>GAS PIPE'S GASKET 1"</td> <td>1</td> <td>PZ</td> </tr> <tr> <td>RC1385B0</td> <td>FLEXIBLE REVOLVING 1 GAS F-F FITTING</td> <td>1</td> <td>PZ</td> </tr> </tbody> </table>	Code	Description	Qty	UOM	GN1542A0	GAS PIPE'S GASKET 1"	1	PZ	RC1385B0	FLEXIBLE REVOLVING 1 GAS F-F FITTING	1	PZ																																				
Code	Description	Qty	UOM																																																		
GN1542A0	GAS PIPE'S GASKET 1"	1	PZ																																																		
RC1385B0	FLEXIBLE REVOLVING 1 GAS F-F FITTING	1	PZ																																																		
BR1359A	REDUCTION PLATE D15																																																				
BR1347B	17,5KW PREMIX BURNER + MOLDED BRACKET KI		KVG1044B	1021/10FS 17.5KW TORCH+IGN. PLUGS KIT	<table border="1"> <thead> <tr> <th>Code</th> <th>Description</th> <th>Qty</th> <th>UOM</th> </tr> </thead> <tbody> <tr> <td>BR1340A2</td> <td>PREMIX START-UP CANDLE</td> <td>3</td> <td>PZ</td> </tr> <tr> <td>BR1347B0</td> <td>17,5KW PREMIX BURNER + MOLDED BRACKET KI</td> <td>1</td> <td>PZ</td> </tr> <tr> <td>BR1360A0</td> <td>TORCH SILENCER GAP H 43</td> <td>1</td> <td>PZ</td> </tr> <tr> <td>GN1542A0</td> <td>GAS PIPE'S GASKET 1"</td> <td>1</td> <td>PZ</td> </tr> <tr> <td>GN1543A0</td> <td>PLUG'S GASKET</td> <td>3</td> <td>PZ</td> </tr> <tr> <td>GN1551A2</td> <td>TORCH-CHAM BER SEALING</td> <td>1</td> <td>PZ</td> </tr> <tr> <td>GN1580A1</td> <td>GAS PIPE SCREW COPPER WASHER</td> <td>5</td> <td>PZ</td> </tr> <tr> <td>GN1586A2</td> <td>TORCH LOWER SEALING</td> <td>2</td> <td>PZ</td> </tr> <tr> <td>IP1385A1</td> <td>CORNER POLYSTYREN E PACKING 110X80X2000</td> <td>0.250</td> <td>M</td> </tr> <tr> <td>RC1385B0</td> <td>FLEXIBLE REVOLVING 1 GAS F-F FITTING</td> <td>1</td> <td>PZ</td> </tr> <tr> <td>VI0504A1</td> <td>INOX NOTCHED M4 WASHER</td> <td>6</td> <td>PZ</td> </tr> </tbody> </table>	Code	Description	Qty	UOM	BR1340A2	PREMIX START-UP CANDLE	3	PZ	BR1347B0	17,5KW PREMIX BURNER + MOLDED BRACKET KI	1	PZ	BR1360A0	TORCH SILENCER GAP H 43	1	PZ	GN1542A0	GAS PIPE'S GASKET 1"	1	PZ	GN1543A0	PLUG'S GASKET	3	PZ	GN1551A2	TORCH-CHAM BER SEALING	1	PZ	GN1580A1	GAS PIPE SCREW COPPER WASHER	5	PZ	GN1586A2	TORCH LOWER SEALING	2	PZ	IP1385A1	CORNER POLYSTYREN E PACKING 110X80X2000	0.250	M	RC1385B0	FLEXIBLE REVOLVING 1 GAS F-F FITTING	1	PZ	VI0504A1	INOX NOTCHED M4 WASHER	6	PZ
Code	Description	Qty	UOM																																																		
BR1340A2	PREMIX START-UP CANDLE	3	PZ																																																		
BR1347B0	17,5KW PREMIX BURNER + MOLDED BRACKET KI	1	PZ																																																		
BR1360A0	TORCH SILENCER GAP H 43	1	PZ																																																		
GN1542A0	GAS PIPE'S GASKET 1"	1	PZ																																																		
GN1543A0	PLUG'S GASKET	3	PZ																																																		
GN1551A2	TORCH-CHAM BER SEALING	1	PZ																																																		
GN1580A1	GAS PIPE SCREW COPPER WASHER	5	PZ																																																		
GN1586A2	TORCH LOWER SEALING	2	PZ																																																		
IP1385A1	CORNER POLYSTYREN E PACKING 110X80X2000	0.250	M																																																		
RC1385B0	FLEXIBLE REVOLVING 1 GAS F-F FITTING	1	PZ																																																		
VI0504A1	INOX NOTCHED M4 WASHER	6	PZ																																																		

COMPONENT			SPARE PART																																																							
Code	Description	Image	Code	Description	Components list																																																					
BR1347B	17,5KW PREMIX BURNER + MOLDED BRACKET KI		KVG1044B	1021/10FS 17.5KW TORCH+IGN. PLUGS KIT	<table border="1"> <thead> <tr> <th>Code</th> <th>Description</th> <th>Qty</th> <th>UOM</th> </tr> </thead> <tbody> <tr> <td>VI2009A2</td> <td>GAS PIPE SCREW BRASS WASHER</td> <td>3</td> <td>PZ</td> </tr> <tr> <td>VI2020A0</td> <td>M4X1 H4 CH 7 BRASS NUT</td> <td>6</td> <td>PZ</td> </tr> </tbody> </table>	Code	Description	Qty	UOM	VI2009A2	GAS PIPE SCREW BRASS WASHER	3	PZ	VI2020A0	M4X1 H4 CH 7 BRASS NUT	6	PZ																																									
			Code	Description	Qty	UOM																																																				
VI2009A2	GAS PIPE SCREW BRASS WASHER	3	PZ																																																							
VI2020A0	M4X1 H4 CH 7 BRASS NUT	6	PZ																																																							
KVG1033B	10EU-G 17.5KW TORCH + IGNITION PLUGS KIT	<table border="1"> <thead> <tr> <th>Code</th> <th>Description</th> <th>Qty</th> <th>UOM</th> </tr> </thead> <tbody> <tr> <td>BR1340A2</td> <td>PREMIX START-UP CANDLE</td> <td>3</td> <td>PZ</td> </tr> <tr> <td>BR1347B0</td> <td>17,5KW PREMIX BURNER + MOLDED BRACKET KI</td> <td>1</td> <td>PZ</td> </tr> <tr> <td>BR1359A1</td> <td>REDUCTION PLATE D15</td> <td>1</td> <td>PZ</td> </tr> <tr> <td>GN1542A0</td> <td>GAS PIPE'S GASKET 1"</td> <td>1</td> <td>PZ</td> </tr> <tr> <td>GN1543A0</td> <td>PLUG'S GASKET</td> <td>3</td> <td>PZ</td> </tr> <tr> <td>GN1551A2</td> <td>TORCH-CHAM BER SEALING</td> <td>1</td> <td>PZ</td> </tr> <tr> <td>GN1580A1</td> <td>GAS PIPE SCREW COPPER WASHER</td> <td>5</td> <td>PZ</td> </tr> <tr> <td>GN1586A2</td> <td>TORCH LOWER SEALING</td> <td>2</td> <td>PZ</td> </tr> <tr> <td>IP1385A1</td> <td>CORNER POLYSTYREN E PACKING 110X80X2000</td> <td>0.270</td> <td>M</td> </tr> <tr> <td>RC1385B0</td> <td>FLEXIBLE REVOLVING 1 GAS F-F FITTING</td> <td>1</td> <td>PZ</td> </tr> <tr> <td>VI0504A1</td> <td>INOX NOTCHED M4 WASHER</td> <td>6</td> <td>PZ</td> </tr> <tr> <td>VI2009A2</td> <td>GAS PIPE SCREW BRASS WASHER</td> <td>3</td> <td>PZ</td> </tr> <tr> <td>VI2020A0</td> <td>M4X1 H4 CH 7 BRASS NUT</td> <td>6</td> <td>PZ</td> </tr> </tbody> </table>	Code	Description	Qty	UOM	BR1340A2	PREMIX START-UP CANDLE	3	PZ	BR1347B0	17,5KW PREMIX BURNER + MOLDED BRACKET KI	1	PZ	BR1359A1	REDUCTION PLATE D15	1	PZ	GN1542A0	GAS PIPE'S GASKET 1"	1	PZ	GN1543A0	PLUG'S GASKET	3	PZ	GN1551A2	TORCH-CHAM BER SEALING	1	PZ	GN1580A1	GAS PIPE SCREW COPPER WASHER	5	PZ	GN1586A2	TORCH LOWER SEALING	2	PZ	IP1385A1	CORNER POLYSTYREN E PACKING 110X80X2000	0.270	M	RC1385B0	FLEXIBLE REVOLVING 1 GAS F-F FITTING	1	PZ	VI0504A1	INOX NOTCHED M4 WASHER	6	PZ	VI2009A2	GAS PIPE SCREW BRASS WASHER	3	PZ	VI2020A0	M4X1 H4 CH 7 BRASS NUT	6	PZ
Code	Description	Qty	UOM																																																							
BR1340A2	PREMIX START-UP CANDLE	3	PZ																																																							
BR1347B0	17,5KW PREMIX BURNER + MOLDED BRACKET KI	1	PZ																																																							
BR1359A1	REDUCTION PLATE D15	1	PZ																																																							
GN1542A0	GAS PIPE'S GASKET 1"	1	PZ																																																							
GN1543A0	PLUG'S GASKET	3	PZ																																																							
GN1551A2	TORCH-CHAM BER SEALING	1	PZ																																																							
GN1580A1	GAS PIPE SCREW COPPER WASHER	5	PZ																																																							
GN1586A2	TORCH LOWER SEALING	2	PZ																																																							
IP1385A1	CORNER POLYSTYREN E PACKING 110X80X2000	0.270	M																																																							
RC1385B0	FLEXIBLE REVOLVING 1 GAS F-F FITTING	1	PZ																																																							
VI0504A1	INOX NOTCHED M4 WASHER	6	PZ																																																							
VI2009A2	GAS PIPE SCREW BRASS WASHER	3	PZ																																																							
VI2020A0	M4X1 H4 CH 7 BRASS NUT	6	PZ																																																							

ASM1776A/0.D04 - External cover

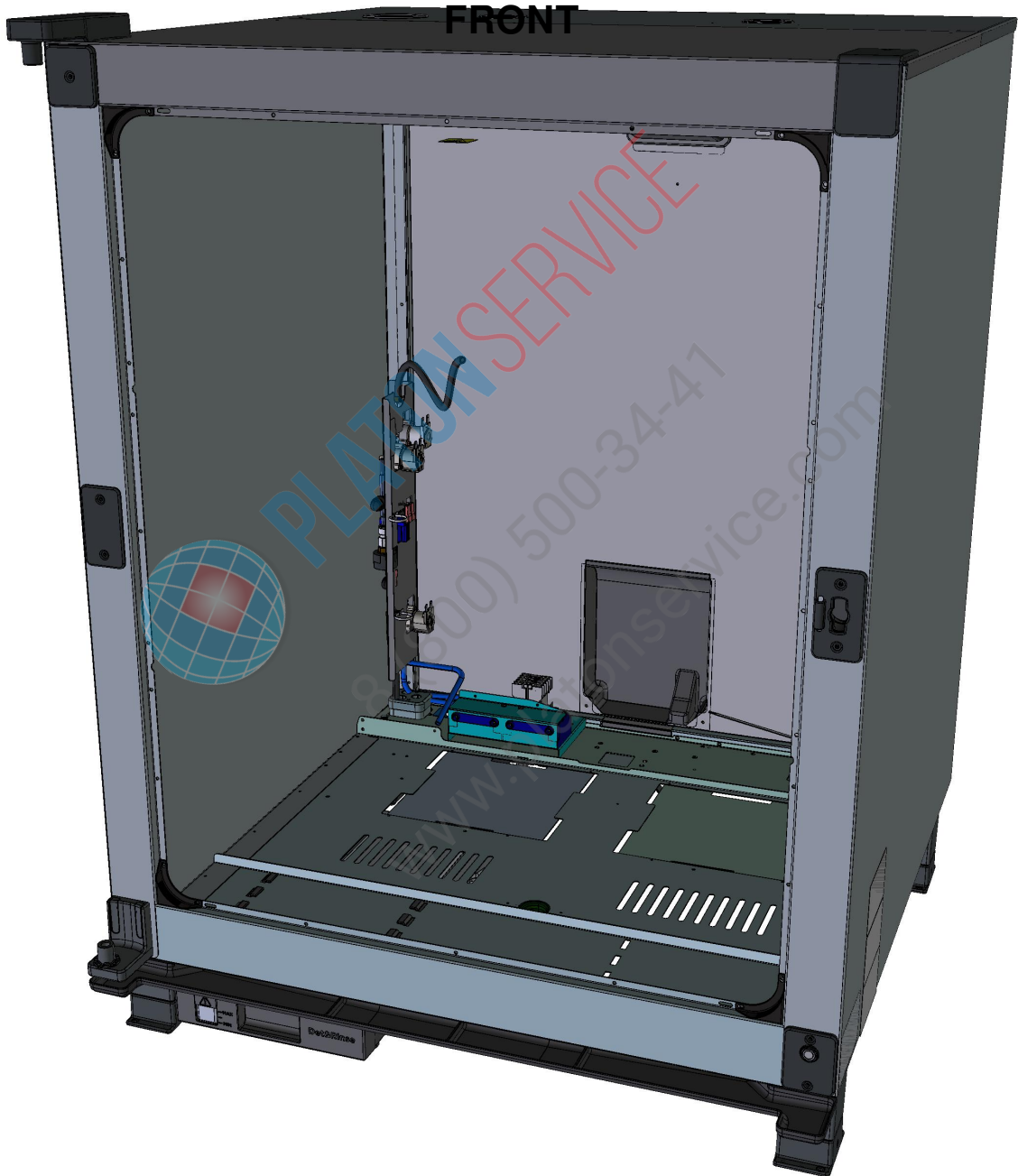







ASM1776A/0.D04 - External cover

REAR



COMPONENT			SPARE PART																										
Code	Description	Image	Code	Description	Components list																								
TR1136A	330°C 1 POLE SAFETY THERMOSTAT		KTR1136A	330°C SAFETY THERMOSTAT KIT	<table border="1"> <thead> <tr> <th>Code</th> <th>Description</th> <th>Qty</th> <th>UOM</th> </tr> </thead> <tbody> <tr> <td>0H7030A0</td> <td>THERMOSTAT BULB INLET COVER</td> <td>1</td> <td>PZ</td> </tr> <tr> <td>GN1531A0</td> <td>THERMOSTAT BULB INLET SEALING</td> <td>1</td> <td>PZ</td> </tr> <tr> <td>SL1045A0</td> <td>S53 BLACK SILICONE - 80ML CARTRIDGE</td> <td>1</td> <td>PZ</td> </tr> <tr> <td>TR1136A0</td> <td>330°C 1 POLE SAFETY THERMOSTAT</td> <td>1</td> <td>PZ</td> </tr> <tr> <td>VI1220A1</td> <td>4,2X12 TCB SELF-TAPPIN G SCREW</td> <td>3</td> <td>PZ</td> </tr> </tbody> </table>	Code	Description	Qty	UOM	0H7030A0	THERMOSTAT BULB INLET COVER	1	PZ	GN1531A0	THERMOSTAT BULB INLET SEALING	1	PZ	SL1045A0	S53 BLACK SILICONE - 80ML CARTRIDGE	1	PZ	TR1136A0	330°C 1 POLE SAFETY THERMOSTAT	1	PZ	VI1220A1	4,2X12 TCB SELF-TAPPIN G SCREW	3	PZ
Code	Description	Qty	UOM																										
0H7030A0	THERMOSTAT BULB INLET COVER	1	PZ																										
GN1531A0	THERMOSTAT BULB INLET SEALING	1	PZ																										
SL1045A0	S53 BLACK SILICONE - 80ML CARTRIDGE	1	PZ																										
TR1136A0	330°C 1 POLE SAFETY THERMOSTAT	1	PZ																										
VI1220A1	4,2X12 TCB SELF-TAPPIN G SCREW	3	PZ																										
VM1750A	BRASS COMB CLAM		KVM1750A	COMB TERMINAL BLOCK KIT	<table border="1"> <thead> <tr> <th>Code</th> <th>Description</th> <th>Qty</th> <th>UOM</th> </tr> </thead> <tbody> <tr> <td>VM1750A0</td> <td>BRASS COMB CLAMP</td> <td>1</td> <td>PZ</td> </tr> </tbody> </table>	Code	Description	Qty	UOM	VM1750A0	BRASS COMB CLAMP	1	PZ																
Code	Description	Qty	UOM																										
VM1750A0	BRASS COMB CLAMP	1	PZ																										
VN1165A	230VAC 50/60HZ COOLING DOWN FA		KVN1165A	230V 120X120 COOLING FAN KIT	<table border="1"> <thead> <tr> <th>Code</th> <th>Description</th> <th>Qty</th> <th>UOM</th> </tr> </thead> <tbody> <tr> <td>VI1099A0</td> <td>SELF-DRILLIN G SCREW 4.8X13 TCB+ Z</td> <td>4</td> <td>PZ</td> </tr> <tr> <td>VM1555A2</td> <td>CT BT COOLING FAN SUPPORT</td> <td>1</td> <td>PZ</td> </tr> <tr> <td>VN1165A0</td> <td>230VAC 50/60HZ COOLING DOWN FAN</td> <td>1</td> <td>PZ</td> </tr> </tbody> </table>	Code	Description	Qty	UOM	VI1099A0	SELF-DRILLIN G SCREW 4.8X13 TCB+ Z	4	PZ	VM1555A2	CT BT COOLING FAN SUPPORT	1	PZ	VN1165A0	230VAC 50/60HZ COOLING DOWN FAN	1	PZ								
Code	Description	Qty	UOM																										
VI1099A0	SELF-DRILLIN G SCREW 4.8X13 TCB+ Z	4	PZ																										
VM1555A2	CT BT COOLING FAN SUPPORT	1	PZ																										
VN1165A0	230VAC 50/60HZ COOLING DOWN FAN	1	PZ																										
VM1556A	XBC-XVC COOLING FAN GUARD		KVM1556A	XBC-XVC COOLING FAN GUARD KIT	<table border="1"> <thead> <tr> <th>Code</th> <th>Description</th> <th>Qty</th> <th>UOM</th> </tr> </thead> <tbody> <tr> <td>VM1556A0</td> <td>XBC-XVC COOLING FAN GUARD</td> <td>1</td> <td>PZ</td> </tr> </tbody> </table>	Code	Description	Qty	UOM	VM1556A0	XBC-XVC COOLING FAN GUARD	1	PZ																
Code	Description	Qty	UOM																										
VM1556A0	XBC-XVC COOLING FAN GUARD	1	PZ																										



COMPONENT			SPARE PART																		
Code	Description	Image	Code	Description	Components list																
VM1555A	CT BT COOLING FAN SUPPORT																				
VL1026A	BEND FOR DRAIN PIPE		KVL1026A	DRAIN PIPE BEND KI	<table border="1"> <thead> <tr> <th>Code</th> <th>Description</th> <th>Qty</th> <th>UOM</th> </tr> </thead> <tbody> <tr> <td>GN1400A0</td> <td>U-TRAP SEAL</td> <td>1</td> <td>PZ</td> </tr> <tr> <td>VL1026A0</td> <td>BEND FOR DRAIN PIPE</td> <td>1</td> <td>PZ</td> </tr> <tr> <td>VM2039A0</td> <td>DRAIN BEND FIXING RING</td> <td>1</td> <td>PZ</td> </tr> </tbody> </table>	Code	Description	Qty	UOM	GN1400A0	U-TRAP SEAL	1	PZ	VL1026A0	BEND FOR DRAIN PIPE	1	PZ	VM2039A0	DRAIN BEND FIXING RING	1	PZ
Code	Description	Qty	UOM																		
GN1400A0	U-TRAP SEAL	1	PZ																		
VL1026A0	BEND FOR DRAIN PIPE	1	PZ																		
VM2039A0	DRAIN BEND FIXING RING	1	PZ																		
VM2039A	DRAIN BEND FIXING RING		KVL1026A	DRAIN PIPE BEND KI	<table border="1"> <thead> <tr> <th>Code</th> <th>Description</th> <th>Qty</th> <th>UOM</th> </tr> </thead> <tbody> <tr> <td>GN1400A0</td> <td>U-TRAP SEAL</td> <td>1</td> <td>PZ</td> </tr> <tr> <td>VL1026A0</td> <td>BEND FOR DRAIN PIPE</td> <td>1</td> <td>PZ</td> </tr> <tr> <td>VM2039A0</td> <td>DRAIN BEND FIXING RING</td> <td>1</td> <td>PZ</td> </tr> </tbody> </table>	Code	Description	Qty	UOM	GN1400A0	U-TRAP SEAL	1	PZ	VL1026A0	BEND FOR DRAIN PIPE	1	PZ	VM2039A0	DRAIN BEND FIXING RING	1	PZ
Code	Description	Qty	UOM																		
GN1400A0	U-TRAP SEAL	1	PZ																		
VL1026A0	BEND FOR DRAIN PIPE	1	PZ																		
VM2039A0	DRAIN BEND FIXING RING	1	PZ																		
0H2561A	6 S. DOOR COUNTERBRACKET		0H2561A0	6 S. DOOR COUNTERBRACKET																	
VM1240A	NYLON SUPPORT CAP		KVM1240A	4 PCS COUNTER BRACKET SUPPORT CAP KIT	<table border="1"> <thead> <tr> <th>Code</th> <th>Description</th> <th>Qty</th> <th>UOM</th> </tr> </thead> <tbody> <tr> <td>VM1240A0</td> <td>NYLON SUPPORT CAP</td> <td>4</td> <td>PZ</td> </tr> </tbody> </table>	Code	Description	Qty	UOM	VM1240A0	NYLON SUPPORT CAP	4	PZ								
Code	Description	Qty	UOM																		
VM1240A0	NYLON SUPPORT CAP	4	PZ																		

COMPONENT			SPARE PART																																		
Code	Description	Image	Code	Description	Components list																																
VM2282A	MICROSWITCH SUPPORT COVER		KVM2282A	MICROSWITCH SUPPORT PLATE KI	<table border="1"> <thead> <tr> <th>Code</th> <th>Description</th> <th>Qty</th> <th>UOM</th> </tr> </thead> <tbody> <tr> <td>VM2282A0</td> <td>MICROSWITC H SUPPORT COVER</td> <td>1</td> <td>PZ</td> </tr> </tbody> </table>	Code	Description	Qty	UOM	VM2282A0	MICROSWITC H SUPPORT COVER	1	PZ																								
Code	Description	Qty	UOM																																		
VM2282A0	MICROSWITC H SUPPORT COVER	1	PZ																																		
VE1020B	MAGNET DOOR MICROSWITCH		KVE1020B	MICROSWITCH KIT	<table border="1"> <thead> <tr> <th>Code</th> <th>Description</th> <th>Qty</th> <th>UOM</th> </tr> </thead> <tbody> <tr> <td>CE1030A0</td> <td>FEMALE FASTON COVER 6.3X0.8 0.5-1MMQ</td> <td>2</td> <td>PZ</td> </tr> <tr> <td>CE1660A0</td> <td>6.3X0,8 FEMALE FASTON COVE</td> <td>2</td> <td>PZ</td> </tr> <tr> <td>CE1730A0</td> <td>PVC CABLE NP 2 X AWG22 STYLE 2095</td> <td>0.150</td> <td>M</td> </tr> <tr> <td>CE1740A0</td> <td>MINIFIT MALE END FITTING</td> <td>2</td> <td>PZ</td> </tr> <tr> <td>CE1745A0</td> <td>2 WAYS FEMALE MINIFIT CONNECTOR</td> <td>1</td> <td>PZ</td> </tr> <tr> <td>VE1020B0</td> <td>MAGNET DOOR MICROSWITC</td> <td>1</td> <td>PZ</td> </tr> <tr> <td>VE1030A1</td> <td>MAGNET FOR DOOR MICROSWITC H D=22,9MM</td> <td>1</td> <td>PZ</td> </tr> </tbody> </table>	Code	Description	Qty	UOM	CE1030A0	FEMALE FASTON COVER 6.3X0.8 0.5-1MMQ	2	PZ	CE1660A0	6.3X0,8 FEMALE FASTON COVE	2	PZ	CE1730A0	PVC CABLE NP 2 X AWG22 STYLE 2095	0.150	M	CE1740A0	MINIFIT MALE END FITTING	2	PZ	CE1745A0	2 WAYS FEMALE MINIFIT CONNECTOR	1	PZ	VE1020B0	MAGNET DOOR MICROSWITC	1	PZ	VE1030A1	MAGNET FOR DOOR MICROSWITC H D=22,9MM	1	PZ
Code	Description	Qty	UOM																																		
CE1030A0	FEMALE FASTON COVER 6.3X0.8 0.5-1MMQ	2	PZ																																		
CE1660A0	6.3X0,8 FEMALE FASTON COVE	2	PZ																																		
CE1730A0	PVC CABLE NP 2 X AWG22 STYLE 2095	0.150	M																																		
CE1740A0	MINIFIT MALE END FITTING	2	PZ																																		
CE1745A0	2 WAYS FEMALE MINIFIT CONNECTOR	1	PZ																																		
VE1020B0	MAGNET DOOR MICROSWITC	1	PZ																																		
VE1030A1	MAGNET FOR DOOR MICROSWITC H D=22,9MM	1	PZ																																		
VM2306A	PIPE STOP PASSIN		KVM2306A	PASSAGE LOCK PIPES CLAMP KIT	<table border="1"> <thead> <tr> <th>Code</th> <th>Description</th> <th>Qty</th> <th>UOM</th> </tr> </thead> <tbody> <tr> <td>VM2306A0</td> <td>PIPE STOP PASSING</td> <td>1</td> <td>PZ</td> </tr> </tbody> </table>	Code	Description	Qty	UOM	VM2306A0	PIPE STOP PASSING	1	PZ																								
Code	Description	Qty	UOM																																		
VM2306A0	PIPE STOP PASSING	1	PZ																																		
VM2307A	PIPE STOP LOCKING COVER		KVM2307A	CLAMPING LOCK PIPES COVER KIT	<table border="1"> <thead> <tr> <th>Code</th> <th>Description</th> <th>Qty</th> <th>UOM</th> </tr> </thead> <tbody> <tr> <td>VM2307A0</td> <td>PIPE STOP LOCKING COVER</td> <td>1</td> <td>PZ</td> </tr> </tbody> </table>	Code	Description	Qty	UOM	VM2307A0	PIPE STOP LOCKING COVER	1	PZ																								
Code	Description	Qty	UOM																																		
VM2307A0	PIPE STOP LOCKING COVER	1	PZ																																		



COMPONENT			SPARE PART																										
Code	Description	Image	Code	Description	Components list																								
RC1006A	D8 PET PIPE GUIDE BEND		KRC1006A	20 PCS. Ø8 PET PIPE GUIDE BEND KI	<table border="1"> <thead> <tr> <th>Code</th> <th>Description</th> <th>Qty</th> <th>UOM</th> </tr> </thead> <tbody> <tr> <td>RC1006A0</td> <td>D8 PET PIPE GUIDE BEND</td> <td>20</td> <td>PZ</td> </tr> </tbody> </table>	Code	Description	Qty	UOM	RC1006A0	D8 PET PIPE GUIDE BEND	20	PZ																
Code	Description	Qty	UOM																										
RC1006A0	D8 PET PIPE GUIDE BEND	20	PZ																										
VM1190A	CT BT RIGHT DOOR SPRING LATCH		KVM1190A	CHEFTOP/BAKERTO P DOOR RIGHT LATCH KIT	<table border="1"> <thead> <tr> <th>Code</th> <th>Description</th> <th>Qty</th> <th>UOM</th> </tr> </thead> <tbody> <tr> <td>VI0239A1</td> <td>SELF-TAPPIN G SCREW 4.2X25 TCB+ INOX</td> <td>2</td> <td>PZ</td> </tr> <tr> <td>VI1220A1</td> <td>4,2X12 TCB SELF-TAPPIN G SCREW</td> <td>2</td> <td>PZ</td> </tr> <tr> <td>VM1190A2</td> <td>CT BT RIGHT DOOR SPRING LATCH</td> <td>1</td> <td>PZ</td> </tr> <tr> <td>VM1192A1</td> <td>CT BT DOOR SPRING LATCH BACK COVER</td> <td>1</td> <td>PZ</td> </tr> <tr> <td>VM1460A0</td> <td>XBC/XVC RIGHT DOOR LATCH CAP</td> <td>1</td> <td>PZ</td> </tr> </tbody> </table>	Code	Description	Qty	UOM	VI0239A1	SELF-TAPPIN G SCREW 4.2X25 TCB+ INOX	2	PZ	VI1220A1	4,2X12 TCB SELF-TAPPIN G SCREW	2	PZ	VM1190A2	CT BT RIGHT DOOR SPRING LATCH	1	PZ	VM1192A1	CT BT DOOR SPRING LATCH BACK COVER	1	PZ	VM1460A0	XBC/XVC RIGHT DOOR LATCH CAP	1	PZ
Code	Description	Qty	UOM																										
VI0239A1	SELF-TAPPIN G SCREW 4.2X25 TCB+ INOX	2	PZ																										
VI1220A1	4,2X12 TCB SELF-TAPPIN G SCREW	2	PZ																										
VM1190A2	CT BT RIGHT DOOR SPRING LATCH	1	PZ																										
VM1192A1	CT BT DOOR SPRING LATCH BACK COVER	1	PZ																										
VM1460A0	XBC/XVC RIGHT DOOR LATCH CAP	1	PZ																										
GN1558A	EXHAUST SEAL		K0H7291A	GASKET AND SEALING DISC CHIMNEY KIT	<table border="1"> <thead> <tr> <th>Code</th> <th>Description</th> <th>Qty</th> <th>UOM</th> </tr> </thead> <tbody> <tr> <td>0H7291A0</td> <td>CHIMNEY HOLDING DISC</td> <td>1</td> <td>PZ</td> </tr> <tr> <td>GN1558A0</td> <td>EXHAUST SEA</td> <td>1</td> <td>PZ</td> </tr> </tbody> </table>	Code	Description	Qty	UOM	0H7291A0	CHIMNEY HOLDING DISC	1	PZ	GN1558A0	EXHAUST SEA	1	PZ												
Code	Description	Qty	UOM																										
0H7291A0	CHIMNEY HOLDING DISC	1	PZ																										
GN1558A0	EXHAUST SEA	1	PZ																										
0H7291A	CHIMNEY HOLDING DISC		K0H7291A	GASKET AND SEALING DISC CHIMNEY KIT	<table border="1"> <thead> <tr> <th>Code</th> <th>Description</th> <th>Qty</th> <th>UOM</th> </tr> </thead> <tbody> <tr> <td>0H7291A0</td> <td>CHIMNEY HOLDING DISC</td> <td>1</td> <td>PZ</td> </tr> <tr> <td>GN1558A0</td> <td>EXHAUST SEA</td> <td>1</td> <td>PZ</td> </tr> </tbody> </table>	Code	Description	Qty	UOM	0H7291A0	CHIMNEY HOLDING DISC	1	PZ	GN1558A0	EXHAUST SEA	1	PZ												
Code	Description	Qty	UOM																										
0H7291A0	CHIMNEY HOLDING DISC	1	PZ																										
GN1558A0	EXHAUST SEA	1	PZ																										

COMPONENT			SPARE PART																																																										
Code	Description	Image	Code	Description	Components list																																																								
VM1118A	DET&RINSE PLUS TANK LEFT GUIDE		KVM1118A	DET&RINSE TANK LEFT GUIDE KIT FOR MM	<table border="1"> <thead> <tr> <th>Code</th> <th>Description</th> <th>Qty</th> <th>UOM</th> </tr> </thead> <tbody> <tr> <td>VI1220A1</td> <td>4,2X12 TCB SELF-TAPPIN G SCREW</td> <td>2</td> <td>PZ</td> </tr> <tr> <td>VM1118A0</td> <td>DET&amp;RINSE PLUS TANK LEFT GUIDE</td> <td>1</td> <td>PZ</td> </tr> </tbody> </table>	Code	Description	Qty	UOM	VI1220A1	4,2X12 TCB SELF-TAPPIN G SCREW	2	PZ	VM1118A0	DET&RINSE PLUS TANK LEFT GUIDE	1	PZ																																												
Code	Description	Qty	UOM																																																										
VI1220A1	4,2X12 TCB SELF-TAPPIN G SCREW	2	PZ																																																										
VM1118A0	DET&RINSE PLUS TANK LEFT GUIDE	1	PZ																																																										
VM1119A	DET&RINSE PLUS TANK RIGHT GUIDE		KVM1119A	DET&RINSE TANK RIGHT GUIDE KIT FOR MM	<table border="1"> <thead> <tr> <th>Code</th> <th>Description</th> <th>Qty</th> <th>UOM</th> </tr> </thead> <tbody> <tr> <td>VI1220A1</td> <td>4,2X12 TCB SELF-TAPPIN G SCREW</td> <td>2</td> <td>PZ</td> </tr> <tr> <td>VM1119A0</td> <td>DET&amp;RINSE PLUS TANK RIGHT GUIDE</td> <td>1</td> <td>PZ</td> </tr> </tbody> </table>	Code	Description	Qty	UOM	VI1220A1	4,2X12 TCB SELF-TAPPIN G SCREW	2	PZ	VM1119A0	DET&RINSE PLUS TANK RIGHT GUIDE	1	PZ																																												
Code	Description	Qty	UOM																																																										
VI1220A1	4,2X12 TCB SELF-TAPPIN G SCREW	2	PZ																																																										
VM1119A0	DET&RINSE PLUS TANK RIGHT GUIDE	1	PZ																																																										
SB1015A	4L DETERGENT TAN		XUC060	DETERGENT TANK KIT FOR PROVER	<table border="1"> <thead> <tr> <th>Code</th> <th>Description</th> <th>Qty</th> <th>UOM</th> </tr> </thead> <tbody> <tr> <td>0H7558B0</td> <td></td> <td>1</td> <td>PZ</td> </tr> <tr> <td>0H7559B0</td> <td></td> <td>2</td> <td>PZ</td> </tr> <tr> <td>0H7656A0</td> <td>DETERGENT TANK GUIDE</td> <td>1</td> <td>PZ</td> </tr> <tr> <td>0H7657A0</td> <td>TANK KIT FRONT</td> <td>2</td> <td>PZ</td> </tr> <tr> <td>CE1016A0</td> <td>EYELET TERMINAL CONNECTOR D=4,3MM</td> <td>2</td> <td>PZ</td> </tr> <tr> <td>CE1630A1</td> <td>BALCK UNIP AWG16 ST.3135 WIRE</td> <td>0.680</td> <td>M</td> </tr> <tr> <td>EL1220A0</td> <td>JG STRAIGHT CONNECTION Ø8F-Ø8F</td> <td>1</td> <td>PZ</td> </tr> <tr> <td>IP1385A1</td> <td>CORNER POLYSTYREN E PACKING 110X80X2000</td> <td>3.520</td> <td>M</td> </tr> <tr> <td>RC1019A0</td> <td>D=10 ELASTIC CLAMP</td> <td>2</td> <td>PZ</td> </tr> <tr> <td>SB1015A1</td> <td>4L DETERGENT TANK</td> <td>1</td> <td>PZ</td> </tr> <tr> <td>TB2820A0</td> <td>PIPE EPDM FOR WASHING SYSTEM</td> <td>2</td> <td>M</td> </tr> <tr> <td>VI1220A1</td> <td>4,2X12 TCB SELF-TAPPIN G SCREW</td> <td>9</td> <td>PZ</td> </tr> <tr> <td>VI1225A0</td> <td>STAINLESS STEEL STRUCTURE RIVET 4X10.1</td> <td>8</td> <td>PZ</td> </tr> </tbody> </table>	Code	Description	Qty	UOM	0H7558B0		1	PZ	0H7559B0		2	PZ	0H7656A0	DETERGENT TANK GUIDE	1	PZ	0H7657A0	TANK KIT FRONT	2	PZ	CE1016A0	EYELET TERMINAL CONNECTOR D=4,3MM	2	PZ	CE1630A1	BALCK UNIP AWG16 ST.3135 WIRE	0.680	M	EL1220A0	JG STRAIGHT CONNECTION Ø8F-Ø8F	1	PZ	IP1385A1	CORNER POLYSTYREN E PACKING 110X80X2000	3.520	M	RC1019A0	D=10 ELASTIC CLAMP	2	PZ	SB1015A1	4L DETERGENT TANK	1	PZ	TB2820A0	PIPE EPDM FOR WASHING SYSTEM	2	M	VI1220A1	4,2X12 TCB SELF-TAPPIN G SCREW	9	PZ	VI1225A0	STAINLESS STEEL STRUCTURE RIVET 4X10.1	8	PZ
Code	Description	Qty	UOM																																																										
0H7558B0		1	PZ																																																										
0H7559B0		2	PZ																																																										
0H7656A0	DETERGENT TANK GUIDE	1	PZ																																																										
0H7657A0	TANK KIT FRONT	2	PZ																																																										
CE1016A0	EYELET TERMINAL CONNECTOR D=4,3MM	2	PZ																																																										
CE1630A1	BALCK UNIP AWG16 ST.3135 WIRE	0.680	M																																																										
EL1220A0	JG STRAIGHT CONNECTION Ø8F-Ø8F	1	PZ																																																										
IP1385A1	CORNER POLYSTYREN E PACKING 110X80X2000	3.520	M																																																										
RC1019A0	D=10 ELASTIC CLAMP	2	PZ																																																										
SB1015A1	4L DETERGENT TANK	1	PZ																																																										
TB2820A0	PIPE EPDM FOR WASHING SYSTEM	2	M																																																										
VI1220A1	4,2X12 TCB SELF-TAPPIN G SCREW	9	PZ																																																										
VI1225A0	STAINLESS STEEL STRUCTURE RIVET 4X10.1	8	PZ																																																										

COMPONENT			SPARE PART																														
Code	Description	Image	Code	Description	Components list																												
SB1015A	4L DETERGENT TAN		XUC060	DETERGENT TANK KIT FOR PROVER	<table border="1"> <thead> <tr> <th>Code</th> <th>Description</th> <th>Qty</th> <th>UOM</th> </tr> </thead> <tbody> <tr> <td>VI1950A0</td> <td>ST. STEEL 4.2X13 TCB SELF-DRILLIN G SCREW</td> <td>4</td> <td>PZ</td> </tr> <tr> <td>VL1047A1</td> <td>D6 PIPE HOLDER - D8 J.G. TERMINAL</td> <td>2</td> <td>PZ</td> </tr> <tr> <td>VL1047A2</td> <td>HOSE D6 TANG D8</td> <td>2</td> <td>PZ</td> </tr> <tr> <td>VM1059A1</td> <td>HEAT SHRINK FILM H800</td> <td>2</td> <td>M</td> </tr> <tr> <td>VM1197A0</td> <td>MM BIG DETERGENT TANK FRAME</td> <td>2</td> <td>PZ</td> </tr> <tr> <td>VM1198A0</td> <td>MM DETERGENT TANK FRAME FIXING CLIP</td> <td>8</td> <td>PZ</td> </tr> </tbody> </table>	Code	Description	Qty	UOM	VI1950A0	ST. STEEL 4.2X13 TCB SELF-DRILLIN G SCREW	4	PZ	VL1047A1	D6 PIPE HOLDER - D8 J.G. TERMINAL	2	PZ	VL1047A2	HOSE D6 TANG D8	2	PZ	VM1059A1	HEAT SHRINK FILM H800	2	M	VM1197A0	MM BIG DETERGENT TANK FRAME	2	PZ	VM1198A0	MM DETERGENT TANK FRAME FIXING CLIP	8	PZ
			Code	Description	Qty	UOM																											
VI1950A0	ST. STEEL 4.2X13 TCB SELF-DRILLIN G SCREW	4	PZ																														
VL1047A1	D6 PIPE HOLDER - D8 J.G. TERMINAL	2	PZ																														
VL1047A2	HOSE D6 TANG D8	2	PZ																														
VM1059A1	HEAT SHRINK FILM H800	2	M																														
VM1197A0	MM BIG DETERGENT TANK FRAME	2	PZ																														
VM1198A0	MM DETERGENT TANK FRAME FIXING CLIP	8	PZ																														
KSB1015A	4L DETERGENT TANK KIT	<table border="1"> <thead> <tr> <th>Code</th> <th>Description</th> <th>Qty</th> <th>UOM</th> </tr> </thead> <tbody> <tr> <td>IP1385A1</td> <td>CORNER POLYSTYREN E PACKING 110X80X2000</td> <td>1.200</td> <td>M</td> </tr> <tr> <td>IP1410A0</td> <td>POLYSTYREN E PACKING TO PROTECT</td> <td>2</td> <td>PZ</td> </tr> <tr> <td>SB1015A1</td> <td>4L DETERGENT TANK</td> <td>1</td> <td>PZ</td> </tr> <tr> <td>VM1059A1</td> <td>HEAT SHRINK FILM H800</td> <td>1.200</td> <td>M</td> </tr> </tbody> </table>	Code	Description	Qty	UOM	IP1385A1	CORNER POLYSTYREN E PACKING 110X80X2000	1.200	M	IP1410A0	POLYSTYREN E PACKING TO PROTECT	2	PZ	SB1015A1	4L DETERGENT TANK	1	PZ	VM1059A1	HEAT SHRINK FILM H800	1.200	M											
Code	Description	Qty	UOM																														
IP1385A1	CORNER POLYSTYREN E PACKING 110X80X2000	1.200	M																														
IP1410A0	POLYSTYREN E PACKING TO PROTECT	2	PZ																														
SB1015A1	4L DETERGENT TANK	1	PZ																														
VM1059A1	HEAT SHRINK FILM H800	1.200	M																														
VM1192A	CT BT DOOR SPRING LATCH BACK COVER		KVM1191A	CHEFTOP/BAKERTO P DOOR LEFT LATCH KIT	<table border="1"> <thead> <tr> <th>Code</th> <th>Description</th> <th>Qty</th> <th>UOM</th> </tr> </thead> <tbody> <tr> <td>VI0239A1</td> <td>SELF-TAPPIN G SCREW 4.2X25 TCB+ INOX</td> <td>2</td> <td>PZ</td> </tr> <tr> <td>VI1220A1</td> <td>4.2X12 TCB SELF-TAPPIN G SCREW</td> <td>2</td> <td>PZ</td> </tr> <tr> <td>VM1191A2</td> <td>CT BT LEFT DOOR SPRING LATCH</td> <td>1</td> <td>PZ</td> </tr> <tr> <td>VM1192A1</td> <td>CT BT DOOR SPRING LATCH BACK COVER</td> <td>1</td> <td>PZ</td> </tr> <tr> <td>VM1460A0</td> <td>XBC/XVC RIGHT DOOR LATCH CAP</td> <td>1</td> <td>PZ</td> </tr> </tbody> </table>	Code	Description	Qty	UOM	VI0239A1	SELF-TAPPIN G SCREW 4.2X25 TCB+ INOX	2	PZ	VI1220A1	4.2X12 TCB SELF-TAPPIN G SCREW	2	PZ	VM1191A2	CT BT LEFT DOOR SPRING LATCH	1	PZ	VM1192A1	CT BT DOOR SPRING LATCH BACK COVER	1	PZ	VM1460A0	XBC/XVC RIGHT DOOR LATCH CAP	1	PZ				
			Code	Description	Qty	UOM																											
			VI0239A1	SELF-TAPPIN G SCREW 4.2X25 TCB+ INOX	2	PZ																											
			VI1220A1	4.2X12 TCB SELF-TAPPIN G SCREW	2	PZ																											
			VM1191A2	CT BT LEFT DOOR SPRING LATCH	1	PZ																											
VM1192A1	CT BT DOOR SPRING LATCH BACK COVER	1	PZ																														
VM1460A0	XBC/XVC RIGHT DOOR LATCH CAP	1	PZ																														



COMPONENT			SPARE PART																										
Code	Description	Image	Code	Description	Components list																								
VM1192A	CT BT DOOR SPRING LATCH BACK COVER		KVM1190A	CHEFTOP/BAKERTO P DOOR RIGHT LATCH KIT	<table border="1"> <thead> <tr> <th>Code</th> <th>Description</th> <th>Qty</th> <th>UOM</th> </tr> </thead> <tbody> <tr> <td>VI0239A1</td> <td>SELF-TAPPIN G SCREW 4.2X25 TCB+ INOX</td> <td>2</td> <td>PZ</td> </tr> <tr> <td>VI1220A1</td> <td>4,2X12 TCB SELF-TAPPIN G SCREW</td> <td>2</td> <td>PZ</td> </tr> <tr> <td>VM1190A2</td> <td>CT BT RIGHT DOOR SPRING LATCH</td> <td>1</td> <td>PZ</td> </tr> <tr> <td>VM1192A1</td> <td>CT BT DOOR SPRING LATCH BACK COVER</td> <td>1</td> <td>PZ</td> </tr> <tr> <td>VM1460A0</td> <td>XBC/XVC RIGHT DOOR LATCH CAP</td> <td>1</td> <td>PZ</td> </tr> </tbody> </table>	Code	Description	Qty	UOM	VI0239A1	SELF-TAPPIN G SCREW 4.2X25 TCB+ INOX	2	PZ	VI1220A1	4,2X12 TCB SELF-TAPPIN G SCREW	2	PZ	VM1190A2	CT BT RIGHT DOOR SPRING LATCH	1	PZ	VM1192A1	CT BT DOOR SPRING LATCH BACK COVER	1	PZ	VM1460A0	XBC/XVC RIGHT DOOR LATCH CAP	1	PZ
Code	Description	Qty	UOM																										
VI0239A1	SELF-TAPPIN G SCREW 4.2X25 TCB+ INOX	2	PZ																										
VI1220A1	4,2X12 TCB SELF-TAPPIN G SCREW	2	PZ																										
VM1190A2	CT BT RIGHT DOOR SPRING LATCH	1	PZ																										
VM1192A1	CT BT DOOR SPRING LATCH BACK COVER	1	PZ																										
VM1460A0	XBC/XVC RIGHT DOOR LATCH CAP	1	PZ																										
VM1191A	CT BT LEFT DOOR SPRING LATCH		KVM1191A	CHEFTOP/BAKERTO P DOOR LEFT LATCH KIT	<table border="1"> <thead> <tr> <th>Code</th> <th>Description</th> <th>Qty</th> <th>UOM</th> </tr> </thead> <tbody> <tr> <td>VI0239A1</td> <td>SELF-TAPPIN G SCREW 4.2X25 TCB+ INOX</td> <td>2</td> <td>PZ</td> </tr> <tr> <td>VI1220A1</td> <td>4,2X12 TCB SELF-TAPPIN G SCREW</td> <td>2</td> <td>PZ</td> </tr> <tr> <td>VM1191A2</td> <td>CT BT LEFT DOOR SPRING LATCH</td> <td>1</td> <td>PZ</td> </tr> <tr> <td>VM1192A1</td> <td>CT BT DOOR SPRING LATCH BACK COVER</td> <td>1</td> <td>PZ</td> </tr> <tr> <td>VM1460A0</td> <td>XBC/XVC RIGHT DOOR LATCH CAP</td> <td>1</td> <td>PZ</td> </tr> </tbody> </table>	Code	Description	Qty	UOM	VI0239A1	SELF-TAPPIN G SCREW 4.2X25 TCB+ INOX	2	PZ	VI1220A1	4,2X12 TCB SELF-TAPPIN G SCREW	2	PZ	VM1191A2	CT BT LEFT DOOR SPRING LATCH	1	PZ	VM1192A1	CT BT DOOR SPRING LATCH BACK COVER	1	PZ	VM1460A0	XBC/XVC RIGHT DOOR LATCH CAP	1	PZ
Code	Description	Qty	UOM																										
VI0239A1	SELF-TAPPIN G SCREW 4.2X25 TCB+ INOX	2	PZ																										
VI1220A1	4,2X12 TCB SELF-TAPPIN G SCREW	2	PZ																										
VM1191A2	CT BT LEFT DOOR SPRING LATCH	1	PZ																										
VM1192A1	CT BT DOOR SPRING LATCH BACK COVER	1	PZ																										
VM1460A0	XBC/XVC RIGHT DOOR LATCH CAP	1	PZ																										
0H7458A	GAS FITTING FIXING PLATE		0H7458A0	GAS FITTING FIXING PLATE																									





COMPONENT			SPARE PART										
Code	Description	Image	Code	Description	Components list								
GN1579A	GAS CHIMENEY'S GASKET (TT)		KGN1579A	2 PCS GAS CHIMENEY GASKET KIT	<table border="1"> <thead> <tr> <th>Code</th> <th>Description</th> <th>Qty</th> <th>UOM</th> </tr> </thead> <tbody> <tr> <td>GN1579A0</td> <td>GAS CHIMENEY'S GASKET (TT)</td> <td>2</td> <td>PZ</td> </tr> </tbody> </table>	Code	Description	Qty	UOM	GN1579A0	GAS CHIMENEY'S GASKET (TT)	2	PZ
Code	Description	Qty	UOM										
GN1579A0	GAS CHIMENEY'S GASKET (TT)	2	PZ										
0H7459A	GAS CHIMNEY EXCHANGES GASKET HOLDER		0H7459A0	GAS CHIMNEY EXCHANGES GASKET HOLDER									
0E1349A			0E1349A0										
0D2315A	XEBC GAS OVEN EXTERNAL FRONT TOP COVER		0D2315A0	XEBC GAS OVEN EXTERNAL FRONT TOP COVER									
0H2561A	6 S. DOOR COUNTERBRACKET		0H2561A0	6 S. DOOR COUNTERBRACKET									





COMPONENT			SPARE PART																						
Code	Description	Image	Code	Description	Components list																				
VI1995A	M5X25 ST.STEEL SCREW		VI1995A0	M5X25 ST.STEEL SCREW																					
VM2352A	LOWER DOOR BRACKET SCREW LEFT COVER		VM2352A0	LOWER DOOR BRACKET SCREW LEFT COVER																					
VM2353A	LOWER DOOR BRACKET SCREW RIGHT COVER		VM2353A0	LOWER DOOR BRACKET SCREW RIGHT COVER																					
VM1240A	NYLON SUPPORT CAP		KVM1240A	4 PCS COUNTER BRACKET SUPPORT CAP KIT	<table border="1"> <thead> <tr> <th>Code</th> <th>Description</th> <th>Qty</th> <th>UOM</th> </tr> </thead> <tbody> <tr> <td>VM1240A0</td> <td>NYLON SUPPORT CAP</td> <td>4</td> <td>PZ</td> </tr> </tbody> </table>	Code	Description	Qty	UOM	VM1240A0	NYLON SUPPORT CAP	4	PZ												
Code	Description	Qty	UOM																						
VM1240A0	NYLON SUPPORT CAP	4	PZ																						
VM2273A	6 S. LEFT LOWER DOOR BRACKET		KVM2273A	MIND.MAPS DOOR LOWER LEFT BRACKET KIT	<table border="1"> <thead> <tr> <th>Code</th> <th>Description</th> <th>Qty</th> <th>UOM</th> </tr> </thead> <tbody> <tr> <td>0H7330A0</td> <td>DOOR LOWER BRACKET WASHER</td> <td>2</td> <td>PZ</td> </tr> <tr> <td>VI1995A0</td> <td>M5X25 ST.STEEL SCREW</td> <td>4</td> <td>PZ</td> </tr> <tr> <td>VM2273A0</td> <td>6 S. LEFT LOWER DOOR BRACKET</td> <td>1</td> <td>PZ</td> </tr> <tr> <td>VM2273A1</td> <td>MM LEFT INFERIOR BRACKET DOOR</td> <td>1</td> <td>PZ</td> </tr> </tbody> </table>	Code	Description	Qty	UOM	0H7330A0	DOOR LOWER BRACKET WASHER	2	PZ	VI1995A0	M5X25 ST.STEEL SCREW	4	PZ	VM2273A0	6 S. LEFT LOWER DOOR BRACKET	1	PZ	VM2273A1	MM LEFT INFERIOR BRACKET DOOR	1	PZ
Code	Description	Qty	UOM																						
0H7330A0	DOOR LOWER BRACKET WASHER	2	PZ																						
VI1995A0	M5X25 ST.STEEL SCREW	4	PZ																						
VM2273A0	6 S. LEFT LOWER DOOR BRACKET	1	PZ																						
VM2273A1	MM LEFT INFERIOR BRACKET DOOR	1	PZ																						



COMPONENT			SPARE PART														
Code	Description	Image	Code	Description	Components list												
VM2273A	6 S. LEFT LOWER DOOR BRACKET		KVM2273A	MIND.MAPS DOOR LOWER LEFT BRACKET KIT	<table border="1"> <thead> <tr> <th>Code</th> <th>Description</th> <th>Qty</th> <th>UOM</th> </tr> </thead> <tbody> <tr> <td>VM2352A0</td> <td>LOWER DOOR BRACKET SCREW LEFT COVER</td> <td>2</td> <td>PZ</td> </tr> <tr> <td>VM2353A0</td> <td>LOWER DOOR BRACKET SCREW RIGHT COVER</td> <td>1</td> <td>PZ</td> </tr> </tbody> </table>	Code	Description	Qty	UOM	VM2352A0	LOWER DOOR BRACKET SCREW LEFT COVER	2	PZ	VM2353A0	LOWER DOOR BRACKET SCREW RIGHT COVER	1	PZ
Code	Description	Qty	UOM														
VM2352A0	LOWER DOOR BRACKET SCREW LEFT COVER	2	PZ														
VM2353A0	LOWER DOOR BRACKET SCREW RIGHT COVER	1	PZ														
0H7675A																	
0H2561A	6 S. DOOR COUNTERBRACKET		0H2561A0	6 S. DOOR COUNTERBRACKET													
VI1995A	M5X25 ST.STEEL SCREW		VI1995A0	M5X25 ST.STEEL SCREW													
VM1240A	NYLON SUPPORT CAP		KVM1240A	4 PCS COUNTER BRACKET SUPPORT CAP KIT	<table border="1"> <thead> <tr> <th>Code</th> <th>Description</th> <th>Qty</th> <th>UOM</th> </tr> </thead> <tbody> <tr> <td>VM1240A0</td> <td>NYLON SUPPORT CAP</td> <td>4</td> <td>PZ</td> </tr> </tbody> </table>	Code	Description	Qty	UOM	VM1240A0	NYLON SUPPORT CAP	4	PZ				
Code	Description	Qty	UOM														
VM1240A0	NYLON SUPPORT CAP	4	PZ														



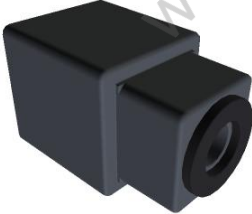

COMPONENT			SPARE PART																										
Code	Description	Image	Code	Description	Components list																								
VM2298A	DOOR BRACKET UPPER COVER		KVM2298A	MIND.MAPS DOOR UPPER BRACKET COVER KIT	<table border="1"> <thead> <tr> <th>Code</th> <th>Description</th> <th>Qty</th> <th>UOM</th> </tr> </thead> <tbody> <tr> <td>VI1220A0</td> <td>SELF-TAPPIN G SCREW 4.2X12 TCB</td> <td>2</td> <td>PZ</td> </tr> <tr> <td>VM2298A0</td> <td>DOOR BRACKET UPPER COVER</td> <td>1</td> <td>PZ</td> </tr> </tbody> </table>	Code	Description	Qty	UOM	VI1220A0	SELF-TAPPIN G SCREW 4.2X12 TCB	2	PZ	VM2298A0	DOOR BRACKET UPPER COVER	1	PZ												
Code	Description	Qty	UOM																										
VI1220A0	SELF-TAPPIN G SCREW 4.2X12 TCB	2	PZ																										
VM2298A0	DOOR BRACKET UPPER COVER	1	PZ																										
VM2271A	LEFT DOOR UPPER BRACKET		KVM2271A	MIND.MAPS UPPER LEFT DOOR BRACKET KIT	<table border="1"> <thead> <tr> <th>Code</th> <th>Description</th> <th>Qty</th> <th>UOM</th> </tr> </thead> <tbody> <tr> <td>VI1220A1</td> <td>4.2X12 TCB SELF-TAPPIN G SCREW</td> <td>2</td> <td>PZ</td> </tr> <tr> <td>VI1995A0</td> <td>M5X25 ST.STEEL SCREW</td> <td>4</td> <td>PZ</td> </tr> <tr> <td>VI1997A0</td> <td>5X10X1 FLAT WASHER</td> <td>4</td> <td>PZ</td> </tr> <tr> <td>VM2271A0</td> <td>LEFT DOOR UPPER BRACKET</td> <td>1</td> <td>PZ</td> </tr> <tr> <td>VM2298A0</td> <td>DOOR BRACKET UPPER COVER</td> <td>1</td> <td>PZ</td> </tr> </tbody> </table>	Code	Description	Qty	UOM	VI1220A1	4.2X12 TCB SELF-TAPPIN G SCREW	2	PZ	VI1995A0	M5X25 ST.STEEL SCREW	4	PZ	VI1997A0	5X10X1 FLAT WASHER	4	PZ	VM2271A0	LEFT DOOR UPPER BRACKET	1	PZ	VM2298A0	DOOR BRACKET UPPER COVER	1	PZ
Code	Description	Qty	UOM																										
VI1220A1	4.2X12 TCB SELF-TAPPIN G SCREW	2	PZ																										
VI1995A0	M5X25 ST.STEEL SCREW	4	PZ																										
VI1997A0	5X10X1 FLAT WASHER	4	PZ																										
VM2271A0	LEFT DOOR UPPER BRACKET	1	PZ																										
VM2298A0	DOOR BRACKET UPPER COVER	1	PZ																										
0H7675A																													
PD1074A	H=100 SQUARE FOOT		KPD1074A	MIND.MAPS H100 FOOT KIT	<table border="1"> <thead> <tr> <th>Code</th> <th>Description</th> <th>Qty</th> <th>UOM</th> </tr> </thead> <tbody> <tr> <td>PD1074A0</td> <td>H=100 SQUARE FOOT</td> <td>1</td> <td>PZ</td> </tr> <tr> <td>PD1075A0</td> <td>FOOT LOCKING BRACKET</td> <td>1</td> <td>PZ</td> </tr> <tr> <td>VI1220A1</td> <td>4.2X12 TCB SELF-TAPPIN G SCREW</td> <td>5</td> <td>PZ</td> </tr> </tbody> </table>	Code	Description	Qty	UOM	PD1074A0	H=100 SQUARE FOOT	1	PZ	PD1075A0	FOOT LOCKING BRACKET	1	PZ	VI1220A1	4.2X12 TCB SELF-TAPPIN G SCREW	5	PZ								
Code	Description	Qty	UOM																										
PD1074A0	H=100 SQUARE FOOT	1	PZ																										
PD1075A0	FOOT LOCKING BRACKET	1	PZ																										
VI1220A1	4.2X12 TCB SELF-TAPPIN G SCREW	5	PZ																										

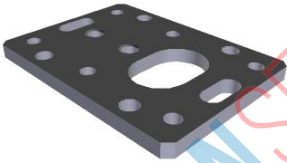

COMPONENT			SPARE PART														
Code	Description	Image	Code	Description	Components list												
PD1075A	FOOT LOCKING BRACKET		KPD1075A	OVEN FOOT STOPPING BRACKET KIT	<table border="1"> <thead> <tr> <th>Code</th> <th>Description</th> <th>Qty</th> <th>UOM</th> </tr> </thead> <tbody> <tr> <td>PD1075A0</td> <td>FOOT LOCKING BRACKET</td> <td>4</td> <td>PZ</td> </tr> <tr> <td>VI1950A0</td> <td>ST. STEEL 4,2X13 TCB SELF-DRILLIN G SCREW</td> <td>8</td> <td>PZ</td> </tr> </tbody> </table>	Code	Description	Qty	UOM	PD1075A0	FOOT LOCKING BRACKET	4	PZ	VI1950A0	ST. STEEL 4,2X13 TCB SELF-DRILLIN G SCREW	8	PZ
Code	Description	Qty	UOM														
PD1075A0	FOOT LOCKING BRACKET	4	PZ														
VI1950A0	ST. STEEL 4,2X13 TCB SELF-DRILLIN G SCREW	8	PZ														
0H2561A	6 S. DOOR COUNTERBRACKET		0H2561A0	6 S. DOOR COUNTERBRACKET													
VM1240A	NYLON SUPPORT CAP		KVM1240A	4 PCS COUNTER BRACKET SUPPORT CAP KIT	<table border="1"> <thead> <tr> <th>Code</th> <th>Description</th> <th>Qty</th> <th>UOM</th> </tr> </thead> <tbody> <tr> <td>VM1240A0</td> <td>NYLON SUPPORT CAP</td> <td>4</td> <td>PZ</td> </tr> </tbody> </table>	Code	Description	Qty	UOM	VM1240A0	NYLON SUPPORT CAP	4	PZ				
Code	Description	Qty	UOM														
VM1240A0	NYLON SUPPORT CAP	4	PZ														
VM2310A	UPPER DOOR BRACKET HOLES COVER		KVM2310A	UPPER BRACKET HOLE COVER KIT	<table border="1"> <thead> <tr> <th>Code</th> <th>Description</th> <th>Qty</th> <th>UOM</th> </tr> </thead> <tbody> <tr> <td>VM2310A0</td> <td>UPPER DOOR BRACKET HOLES COVER</td> <td>1</td> <td>PZ</td> </tr> </tbody> </table>	Code	Description	Qty	UOM	VM2310A0	UPPER DOOR BRACKET HOLES COVER	1	PZ				
Code	Description	Qty	UOM														
VM2310A0	UPPER DOOR BRACKET HOLES COVER	1	PZ														
0H7675A																	

COMPONENT			SPARE PART																																																						
Code	Description	Image	Code	Description	Components list																																																				
PD1074A	H=100 SQUARE FOO		KPD1074A	MIND.MAPS H100 FOOT KIT	<table border="1"> <thead> <tr> <th>Code</th> <th>Description</th> <th>Qty</th> <th>UOM</th> </tr> </thead> <tbody> <tr> <td>PD1074A0</td> <td>H=100 SQUARE FOO</td> <td>1</td> <td>PZ</td> </tr> <tr> <td>PD1075A0</td> <td>FOOT LOCKING BRACKET</td> <td>1</td> <td>PZ</td> </tr> <tr> <td>VI1220A1</td> <td>4,2X12 TCB SELF-TAPPIN G SCREW</td> <td>5</td> <td>PZ</td> </tr> </tbody> </table>	Code	Description	Qty	UOM	PD1074A0	H=100 SQUARE FOO	1	PZ	PD1075A0	FOOT LOCKING BRACKET	1	PZ	VI1220A1	4,2X12 TCB SELF-TAPPIN G SCREW	5	PZ																																				
Code	Description	Qty	UOM																																																						
PD1074A0	H=100 SQUARE FOO	1	PZ																																																						
PD1075A0	FOOT LOCKING BRACKET	1	PZ																																																						
VI1220A1	4,2X12 TCB SELF-TAPPIN G SCREW	5	PZ																																																						
PD1075A	FOOT LOCKING BRACKET		KPD1075A	OVEN FOOT STOPPING BRACKET KIT	<table border="1"> <thead> <tr> <th>Code</th> <th>Description</th> <th>Qty</th> <th>UOM</th> </tr> </thead> <tbody> <tr> <td>PD1075A0</td> <td>FOOT LOCKING BRACKET</td> <td>4</td> <td>PZ</td> </tr> <tr> <td>VI1950A0</td> <td>ST. STEEL 4,2X13 TCB SELF-DRILLIN G SCREW</td> <td>8</td> <td>PZ</td> </tr> </tbody> </table>	Code	Description	Qty	UOM	PD1075A0	FOOT LOCKING BRACKET	4	PZ	VI1950A0	ST. STEEL 4,2X13 TCB SELF-DRILLIN G SCREW	8	PZ																																								
Code	Description	Qty	UOM																																																						
PD1075A0	FOOT LOCKING BRACKET	4	PZ																																																						
VI1950A0	ST. STEEL 4,2X13 TCB SELF-DRILLIN G SCREW	8	PZ																																																						
RC1243A	Ø10F-Ø10M ELBOW CONNECTION + JG END KIT		KVL1117A	EUR MM 2016+LMT FILTER+PRESS. RED. KIT	<table border="1"> <thead> <tr> <th>Code</th> <th>Description</th> <th>Qty</th> <th>UOM</th> </tr> </thead> <tbody> <tr> <td>0H7472A1</td> <td>DISTRIBUTOR SUPPORT PLATE</td> <td>1</td> <td>PZ</td> </tr> <tr> <td>RC1004A0</td> <td>Ø10-Ø8-8 Y CONNECTION</td> <td>1</td> <td>PZ</td> </tr> <tr> <td>RC1243A0</td> <td>Ø10F-Ø10M ELBOW CONNECTION + JG END KIT</td> <td>1</td> <td>PZ</td> </tr> <tr> <td>RC1372A0</td> <td>Ø10M-1/4 M CIL. STRAIGHT FITTING</td> <td>2</td> <td>PZ</td> </tr> <tr> <td>VI1013A1</td> <td>30.5X39.5X3 NYLON FLAT WASHER</td> <td>1</td> <td>PZ</td> </tr> <tr> <td>VI1220A1</td> <td>4,2X12 TCB SELF-TAPPIN G SCREW</td> <td>2</td> <td>PZ</td> </tr> <tr> <td>VL1014A0</td> <td>PRESSURE REDUCER WITH DISTRIBUTOR</td> <td>1</td> <td>PZ</td> </tr> <tr> <td>VL1014B0</td> <td>PRESSURE REDUCER WITH DISTRIBUTOR</td> <td>1</td> <td>PZ</td> </tr> <tr> <td>VL1034C0</td> <td>MESH WATER FILTER D10</td> <td>1</td> <td>PZ</td> </tr> <tr> <td>VL1062C0</td> <td>PRESSURE REDUCER-FILTER LOCKING FORK</td> <td>1</td> <td>PZ</td> </tr> <tr> <td>VM1053A0</td> <td>1/8" CAP + O-RING</td> <td>2</td> <td>PZ</td> </tr> <tr> <td>VM1054A0</td> <td>H7.8 PRESSURE REDUCER RING NUT</td> <td>1</td> <td>PZ</td> </tr> </tbody> </table>	Code	Description	Qty	UOM	0H7472A1	DISTRIBUTOR SUPPORT PLATE	1	PZ	RC1004A0	Ø10-Ø8-8 Y CONNECTION	1	PZ	RC1243A0	Ø10F-Ø10M ELBOW CONNECTION + JG END KIT	1	PZ	RC1372A0	Ø10M-1/4 M CIL. STRAIGHT FITTING	2	PZ	VI1013A1	30.5X39.5X3 NYLON FLAT WASHER	1	PZ	VI1220A1	4,2X12 TCB SELF-TAPPIN G SCREW	2	PZ	VL1014A0	PRESSURE REDUCER WITH DISTRIBUTOR	1	PZ	VL1014B0	PRESSURE REDUCER WITH DISTRIBUTOR	1	PZ	VL1034C0	MESH WATER FILTER D10	1	PZ	VL1062C0	PRESSURE REDUCER-FILTER LOCKING FORK	1	PZ	VM1053A0	1/8" CAP + O-RING	2	PZ	VM1054A0	H7.8 PRESSURE REDUCER RING NUT	1	PZ
Code	Description	Qty	UOM																																																						
0H7472A1	DISTRIBUTOR SUPPORT PLATE	1	PZ																																																						
RC1004A0	Ø10-Ø8-8 Y CONNECTION	1	PZ																																																						
RC1243A0	Ø10F-Ø10M ELBOW CONNECTION + JG END KIT	1	PZ																																																						
RC1372A0	Ø10M-1/4 M CIL. STRAIGHT FITTING	2	PZ																																																						
VI1013A1	30.5X39.5X3 NYLON FLAT WASHER	1	PZ																																																						
VI1220A1	4,2X12 TCB SELF-TAPPIN G SCREW	2	PZ																																																						
VL1014A0	PRESSURE REDUCER WITH DISTRIBUTOR	1	PZ																																																						
VL1014B0	PRESSURE REDUCER WITH DISTRIBUTOR	1	PZ																																																						
VL1034C0	MESH WATER FILTER D10	1	PZ																																																						
VL1062C0	PRESSURE REDUCER-FILTER LOCKING FORK	1	PZ																																																						
VM1053A0	1/8" CAP + O-RING	2	PZ																																																						
VM1054A0	H7.8 PRESSURE REDUCER RING NUT	1	PZ																																																						

COMPONENT			SPARE PART																																																						
Code	Description	Image	Code	Description	Components list																																																				
RC1243A	Ø10F-Ø10M ELBOW CONNECTION + JG END KIT		KRC1243A	Ø10F-Ø10M ELBOW CONNECTION + JG END KIT	<table border="1"> <thead> <tr> <th>Code</th> <th>Description</th> <th>Qty</th> <th>UOM</th> </tr> </thead> <tbody> <tr> <td>RC1243A0</td> <td>Ø10F-Ø10M ELBOW CONNECTION + JG END KIT</td> <td>10</td> <td>PZ</td> </tr> </tbody> </table>	Code	Description	Qty	UOM	RC1243A0	Ø10F-Ø10M ELBOW CONNECTION + JG END KIT	10	PZ																																												
Code	Description	Qty	UOM																																																						
RC1243A0	Ø10F-Ø10M ELBOW CONNECTION + JG END KIT	10	PZ																																																						
VM1054A	H7.8 PRESSURE REDUCER RING NUT		KVM1054A	H7.8 PRESSURE REDUCER DIAL KIT	<table border="1"> <thead> <tr> <th>Code</th> <th>Description</th> <th>Qty</th> <th>UOM</th> </tr> </thead> <tbody> <tr> <td>VM1054A0</td> <td>H7.8 PRESSURE REDUCER RING NUT</td> <td>1</td> <td>PZ</td> </tr> </tbody> </table>	Code	Description	Qty	UOM	VM1054A0	H7.8 PRESSURE REDUCER RING NUT	1	PZ																																												
Code	Description	Qty	UOM																																																						
VM1054A0	H7.8 PRESSURE REDUCER RING NUT	1	PZ																																																						
			KVL1117A	EUR MM 2016+LMT FILTER+PRESS. RED. KIT	<table border="1"> <thead> <tr> <th>Code</th> <th>Description</th> <th>Qty</th> <th>UOM</th> </tr> </thead> <tbody> <tr> <td>0H7472A1</td> <td>DISTRIBUTOR SUPPORT PLATE</td> <td>1</td> <td>PZ</td> </tr> <tr> <td>RC1004A0</td> <td>Ø10-Ø8-8 Y CONNECTION</td> <td>1</td> <td>PZ</td> </tr> <tr> <td>RC1243A0</td> <td>Ø10F-Ø10M ELBOW CONNECTION + JG END KIT</td> <td>1</td> <td>PZ</td> </tr> <tr> <td>RC1372A0</td> <td>Ø10M-1/4 M CIL. STRAIGHT FITTING</td> <td>2</td> <td>PZ</td> </tr> <tr> <td>VI1013A1</td> <td>30.5X39.5X3 NYLON FLAT WASHER</td> <td>1</td> <td>PZ</td> </tr> <tr> <td>VI1220A1</td> <td>4,2X12 TCB SELF-TAPPING SCREW</td> <td>2</td> <td>PZ</td> </tr> <tr> <td>VL1014A0</td> <td>PRESSURE REDUCER WITH DISTRIBUTOR</td> <td>1</td> <td>PZ</td> </tr> <tr> <td>VL1014B0</td> <td>PRESSURE REDUCER WITH DISTRIBUTOR</td> <td>1</td> <td>PZ</td> </tr> <tr> <td>VL1034C0</td> <td>MESH WATER FILTER D10</td> <td>1</td> <td>PZ</td> </tr> <tr> <td>VL1062C0</td> <td>PRESSURE REDUCER-FILTER LOCKING FORK</td> <td>1</td> <td>PZ</td> </tr> <tr> <td>VM1053A0</td> <td>1/8" CAP + O-RING</td> <td>2</td> <td>PZ</td> </tr> <tr> <td>VM1054A0</td> <td>H7.8 PRESSURE REDUCER RING NUT</td> <td>1</td> <td>PZ</td> </tr> </tbody> </table>	Code	Description	Qty	UOM	0H7472A1	DISTRIBUTOR SUPPORT PLATE	1	PZ	RC1004A0	Ø10-Ø8-8 Y CONNECTION	1	PZ	RC1243A0	Ø10F-Ø10M ELBOW CONNECTION + JG END KIT	1	PZ	RC1372A0	Ø10M-1/4 M CIL. STRAIGHT FITTING	2	PZ	VI1013A1	30.5X39.5X3 NYLON FLAT WASHER	1	PZ	VI1220A1	4,2X12 TCB SELF-TAPPING SCREW	2	PZ	VL1014A0	PRESSURE REDUCER WITH DISTRIBUTOR	1	PZ	VL1014B0	PRESSURE REDUCER WITH DISTRIBUTOR	1	PZ	VL1034C0	MESH WATER FILTER D10	1	PZ	VL1062C0	PRESSURE REDUCER-FILTER LOCKING FORK	1	PZ	VM1053A0	1/8" CAP + O-RING	2	PZ	VM1054A0	H7.8 PRESSURE REDUCER RING NUT	1	PZ
Code	Description	Qty	UOM																																																						
0H7472A1	DISTRIBUTOR SUPPORT PLATE	1	PZ																																																						
RC1004A0	Ø10-Ø8-8 Y CONNECTION	1	PZ																																																						
RC1243A0	Ø10F-Ø10M ELBOW CONNECTION + JG END KIT	1	PZ																																																						
RC1372A0	Ø10M-1/4 M CIL. STRAIGHT FITTING	2	PZ																																																						
VI1013A1	30.5X39.5X3 NYLON FLAT WASHER	1	PZ																																																						
VI1220A1	4,2X12 TCB SELF-TAPPING SCREW	2	PZ																																																						
VL1014A0	PRESSURE REDUCER WITH DISTRIBUTOR	1	PZ																																																						
VL1014B0	PRESSURE REDUCER WITH DISTRIBUTOR	1	PZ																																																						
VL1034C0	MESH WATER FILTER D10	1	PZ																																																						
VL1062C0	PRESSURE REDUCER-FILTER LOCKING FORK	1	PZ																																																						
VM1053A0	1/8" CAP + O-RING	2	PZ																																																						
VM1054A0	H7.8 PRESSURE REDUCER RING NUT	1	PZ																																																						

COMPONENT			SPARE PART																																																						
Code	Description	Image	Code	Description	Components list																																																				
RC1004A	Ø10-Ø8-8 Y CONNECTION		KVL1117A	EUR MM 2016+LMT FILTER+PRESS. RED. KIT	<table border="1"> <thead> <tr> <th>Code</th> <th>Description</th> <th>Qty</th> <th>UOM</th> </tr> </thead> <tbody> <tr> <td>0H7472A1</td> <td>DISTRIBUTOR SUPPORT PLATE</td> <td>1</td> <td>PZ</td> </tr> <tr> <td>RC1004A0</td> <td>Ø10-Ø8-8 Y CONNECTION</td> <td>1</td> <td>PZ</td> </tr> <tr> <td>RC1243A0</td> <td>Ø10F-Ø10M ELBOW CONNECTION + JG END KIT</td> <td>1</td> <td>PZ</td> </tr> <tr> <td>RC1372A0</td> <td>Ø10M-1/4 M CIL. STRAIGHT FITTING</td> <td>2</td> <td>PZ</td> </tr> <tr> <td>VI1013A1</td> <td>30.5X39.5X3 NYLON FLAT WASHER</td> <td>1</td> <td>PZ</td> </tr> <tr> <td>VI1220A1</td> <td>4,2X12 TCB SELF-TAPPIN G SCREW</td> <td>2</td> <td>PZ</td> </tr> <tr> <td>VL1014A0</td> <td>PRESSURE REDUCER WITH DISTRIBUTOR</td> <td>1</td> <td>PZ</td> </tr> <tr> <td>VL1014B0</td> <td>PRESSURE REDUCER WITH DISTRIBUTOR</td> <td>1</td> <td>PZ</td> </tr> <tr> <td>VL1034C0</td> <td>MESH WATER FILTER D10</td> <td>1</td> <td>PZ</td> </tr> <tr> <td>VL1062C0</td> <td>PRESSURE REDUCER-FIL TER LOCKING FORK</td> <td>1</td> <td>PZ</td> </tr> <tr> <td>VM1053A0</td> <td>1/8" CAP + O-RING</td> <td>2</td> <td>PZ</td> </tr> <tr> <td>VM1054A0</td> <td>H7.8 PRESSURE REDUCER RING NUT</td> <td>1</td> <td>PZ</td> </tr> </tbody> </table>	Code	Description	Qty	UOM	0H7472A1	DISTRIBUTOR SUPPORT PLATE	1	PZ	RC1004A0	Ø10-Ø8-8 Y CONNECTION	1	PZ	RC1243A0	Ø10F-Ø10M ELBOW CONNECTION + JG END KIT	1	PZ	RC1372A0	Ø10M-1/4 M CIL. STRAIGHT FITTING	2	PZ	VI1013A1	30.5X39.5X3 NYLON FLAT WASHER	1	PZ	VI1220A1	4,2X12 TCB SELF-TAPPIN G SCREW	2	PZ	VL1014A0	PRESSURE REDUCER WITH DISTRIBUTOR	1	PZ	VL1014B0	PRESSURE REDUCER WITH DISTRIBUTOR	1	PZ	VL1034C0	MESH WATER FILTER D10	1	PZ	VL1062C0	PRESSURE REDUCER-FIL TER LOCKING FORK	1	PZ	VM1053A0	1/8" CAP + O-RING	2	PZ	VM1054A0	H7.8 PRESSURE REDUCER RING NUT	1	PZ
			Code	Description	Qty	UOM																																																			
0H7472A1	DISTRIBUTOR SUPPORT PLATE	1	PZ																																																						
RC1004A0	Ø10-Ø8-8 Y CONNECTION	1	PZ																																																						
RC1243A0	Ø10F-Ø10M ELBOW CONNECTION + JG END KIT	1	PZ																																																						
RC1372A0	Ø10M-1/4 M CIL. STRAIGHT FITTING	2	PZ																																																						
VI1013A1	30.5X39.5X3 NYLON FLAT WASHER	1	PZ																																																						
VI1220A1	4,2X12 TCB SELF-TAPPIN G SCREW	2	PZ																																																						
VL1014A0	PRESSURE REDUCER WITH DISTRIBUTOR	1	PZ																																																						
VL1014B0	PRESSURE REDUCER WITH DISTRIBUTOR	1	PZ																																																						
VL1034C0	MESH WATER FILTER D10	1	PZ																																																						
VL1062C0	PRESSURE REDUCER-FIL TER LOCKING FORK	1	PZ																																																						
VM1053A0	1/8" CAP + O-RING	2	PZ																																																						
VM1054A0	H7.8 PRESSURE REDUCER RING NUT	1	PZ																																																						
KRC1004A	10 PCS. Ø10-Ø8-8 Y FITTING KIT																																																								
VL1034C	MESH WATER FILTER D10		KVL1117A	EUR MM 2016+LMT FILTER+PRESS. RED. KIT	<table border="1"> <thead> <tr> <th>Code</th> <th>Description</th> <th>Qty</th> <th>UOM</th> </tr> </thead> <tbody> <tr> <td>0H7472A1</td> <td>DISTRIBUTOR SUPPORT PLATE</td> <td>1</td> <td>PZ</td> </tr> <tr> <td>RC1004A0</td> <td>Ø10-Ø8-8 Y CONNECTION</td> <td>1</td> <td>PZ</td> </tr> <tr> <td>RC1243A0</td> <td>Ø10F-Ø10M ELBOW CONNECTION + JG END KIT</td> <td>1</td> <td>PZ</td> </tr> </tbody> </table>	Code	Description	Qty	UOM	0H7472A1	DISTRIBUTOR SUPPORT PLATE	1	PZ	RC1004A0	Ø10-Ø8-8 Y CONNECTION	1	PZ	RC1243A0	Ø10F-Ø10M ELBOW CONNECTION + JG END KIT	1	PZ																																				
			Code	Description	Qty	UOM																																																			
0H7472A1	DISTRIBUTOR SUPPORT PLATE	1	PZ																																																						
RC1004A0	Ø10-Ø8-8 Y CONNECTION	1	PZ																																																						
RC1243A0	Ø10F-Ø10M ELBOW CONNECTION + JG END KIT	1	PZ																																																						



COMPONENT			SPARE PART																																										
Code	Description	Image	Code	Description	Components list																																								
VL1034C	MESH WATER FILTER D10		KVL1117A	EUR MM 2016+LMT FILTER+PRESS. RED. KIT	<table border="1"> <thead> <tr> <th>Code</th> <th>Description</th> <th>Qty</th> <th>UOM</th> </tr> </thead> <tbody> <tr> <td>RC1372A0</td> <td>Ø10M-1/4 M CIL. STRAIGHT FITTING</td> <td>2</td> <td>PZ</td> </tr> <tr> <td>VI1013A1</td> <td>30.5X39.5X3 NYLON FLAT WASHER</td> <td>1</td> <td>PZ</td> </tr> <tr> <td>VI1220A1</td> <td>4,2X12 TCB SELF-TAPPIN G SCREW</td> <td>2</td> <td>PZ</td> </tr> <tr> <td>VL1014A0</td> <td>PRESSURE REDUCER WITH DISTRIBUTOR</td> <td>1</td> <td>PZ</td> </tr> <tr> <td>VL1014B0</td> <td>PRESSURE REDUCER WITH DISTRIBUTOR</td> <td>1</td> <td>PZ</td> </tr> <tr> <td>VL1034C0</td> <td>MESH WATER FILTER D10</td> <td>1</td> <td>PZ</td> </tr> <tr> <td>VL1062C0</td> <td>PRESSURE REDUCER-FIL TER LOCKING FORK</td> <td>1</td> <td>PZ</td> </tr> <tr> <td>VM1053A0</td> <td>1/8" CAP + O-RING</td> <td>2</td> <td>PZ</td> </tr> <tr> <td>VM1054A0</td> <td>H7.8 PRESSURE REDUCER RING NUT</td> <td>1</td> <td>PZ</td> </tr> </tbody> </table>	Code	Description	Qty	UOM	RC1372A0	Ø10M-1/4 M CIL. STRAIGHT FITTING	2	PZ	VI1013A1	30.5X39.5X3 NYLON FLAT WASHER	1	PZ	VI1220A1	4,2X12 TCB SELF-TAPPIN G SCREW	2	PZ	VL1014A0	PRESSURE REDUCER WITH DISTRIBUTOR	1	PZ	VL1014B0	PRESSURE REDUCER WITH DISTRIBUTOR	1	PZ	VL1034C0	MESH WATER FILTER D10	1	PZ	VL1062C0	PRESSURE REDUCER-FIL TER LOCKING FORK	1	PZ	VM1053A0	1/8" CAP + O-RING	2	PZ	VM1054A0	H7.8 PRESSURE REDUCER RING NUT	1	PZ
					Code	Description	Qty	UOM																																					
RC1372A0	Ø10M-1/4 M CIL. STRAIGHT FITTING	2	PZ																																										
VI1013A1	30.5X39.5X3 NYLON FLAT WASHER	1	PZ																																										
VI1220A1	4,2X12 TCB SELF-TAPPIN G SCREW	2	PZ																																										
VL1014A0	PRESSURE REDUCER WITH DISTRIBUTOR	1	PZ																																										
VL1014B0	PRESSURE REDUCER WITH DISTRIBUTOR	1	PZ																																										
VL1034C0	MESH WATER FILTER D10	1	PZ																																										
VL1062C0	PRESSURE REDUCER-FIL TER LOCKING FORK	1	PZ																																										
VM1053A0	1/8" CAP + O-RING	2	PZ																																										
VM1054A0	H7.8 PRESSURE REDUCER RING NUT	1	PZ																																										
KVL1034C	Ø8-Ø10 MESH100 WATER FILTER KIT	<table border="1"> <thead> <tr> <th>Code</th> <th>Description</th> <th>Qty</th> <th>UOM</th> </tr> </thead> <tbody> <tr> <td>RC1002A0</td> <td>JG 10M-8F TERMINAL REDUCTION FITTING</td> <td>2</td> <td>PZ</td> </tr> <tr> <td>VL1034C0</td> <td>MESH WATER FILTER D10</td> <td>1</td> <td>PZ</td> </tr> <tr> <td>VL1062C0</td> <td>PRESSURE REDUCER-FIL TER LOCKING FORK</td> <td>1</td> <td>PZ</td> </tr> </tbody> </table>	Code	Description	Qty	UOM	RC1002A0	JG 10M-8F TERMINAL REDUCTION FITTING	2	PZ	VL1034C0	MESH WATER FILTER D10	1	PZ	VL1062C0	PRESSURE REDUCER-FIL TER LOCKING FORK	1	PZ																											
Code	Description	Qty	UOM																																										
RC1002A0	JG 10M-8F TERMINAL REDUCTION FITTING	2	PZ																																										
VL1034C0	MESH WATER FILTER D10	1	PZ																																										
VL1062C0	PRESSURE REDUCER-FIL TER LOCKING FORK	1	PZ																																										
VL1062C	PRESSURE REDUCER-FILTER LOCKING FORK		KVL1117A	EUR MM 2016+LMT FILTER+PRESS. RED. KIT	<table border="1"> <thead> <tr> <th>Code</th> <th>Description</th> <th>Qty</th> <th>UOM</th> </tr> </thead> <tbody> <tr> <td>0H7472A1</td> <td>DISTRIBUTOR SUPPORT PLATE</td> <td>1</td> <td>PZ</td> </tr> <tr> <td>RC1004A0</td> <td>Ø10-Ø8-8 Y CONNECTION</td> <td>1</td> <td>PZ</td> </tr> <tr> <td>RC1243A0</td> <td>Ø10F-Ø10M ELBOW CONNECTION + JG END KIT</td> <td>1</td> <td>PZ</td> </tr> <tr> <td>RC1372A0</td> <td>Ø10M-1/4 M CIL. STRAIGHT FITTING</td> <td>2</td> <td>PZ</td> </tr> </tbody> </table>	Code	Description	Qty	UOM	0H7472A1	DISTRIBUTOR SUPPORT PLATE	1	PZ	RC1004A0	Ø10-Ø8-8 Y CONNECTION	1	PZ	RC1243A0	Ø10F-Ø10M ELBOW CONNECTION + JG END KIT	1	PZ	RC1372A0	Ø10M-1/4 M CIL. STRAIGHT FITTING	2	PZ																				
					Code	Description	Qty	UOM																																					
					0H7472A1	DISTRIBUTOR SUPPORT PLATE	1	PZ																																					
					RC1004A0	Ø10-Ø8-8 Y CONNECTION	1	PZ																																					
RC1243A0	Ø10F-Ø10M ELBOW CONNECTION + JG END KIT	1	PZ																																										
RC1372A0	Ø10M-1/4 M CIL. STRAIGHT FITTING	2	PZ																																										

COMPONENT			SPARE PART																																						
Code	Description	Image	Code	Description	Components list																																				
VL1062C	PRESSURE REDUCER-FILTER LOCKING FORK		KVL1117A	EUR MM 2016+LMT FILTER+PRESS. RED. KIT	<table border="1"> <thead> <tr> <th>Code</th> <th>Description</th> <th>Qty</th> <th>UOM</th> </tr> </thead> <tbody> <tr> <td>VI1013A1</td> <td>30.5X39.5X3 NYLON FLAT WASHER</td> <td>1</td> <td>PZ</td> </tr> <tr> <td>VI1220A1</td> <td>4,2X12 TCB SELF-TAPPIN G SCREW</td> <td>2</td> <td>PZ</td> </tr> <tr> <td>VL1014A0</td> <td>PRESSURE REDUCER WITH DISTRIBUTOR</td> <td>1</td> <td>PZ</td> </tr> <tr> <td>VL1014B0</td> <td>PRESSURE REDUCER WITH DISTRIBUTOR</td> <td>1</td> <td>PZ</td> </tr> <tr> <td>VL1034C0</td> <td>MESH WATER FILTER D10</td> <td>1</td> <td>PZ</td> </tr> <tr> <td>VL1062C0</td> <td>PRESSURE REDUCER-FIL TER LOCKING FORK</td> <td>1</td> <td>PZ</td> </tr> <tr> <td>VM1053A0</td> <td>1/8" CAP + O-RING</td> <td>2</td> <td>PZ</td> </tr> <tr> <td>VM1054A0</td> <td>H7.8 PRESSURE REDUCER RING NUT</td> <td>1</td> <td>PZ</td> </tr> </tbody> </table>	Code	Description	Qty	UOM	VI1013A1	30.5X39.5X3 NYLON FLAT WASHER	1	PZ	VI1220A1	4,2X12 TCB SELF-TAPPIN G SCREW	2	PZ	VL1014A0	PRESSURE REDUCER WITH DISTRIBUTOR	1	PZ	VL1014B0	PRESSURE REDUCER WITH DISTRIBUTOR	1	PZ	VL1034C0	MESH WATER FILTER D10	1	PZ	VL1062C0	PRESSURE REDUCER-FIL TER LOCKING FORK	1	PZ	VM1053A0	1/8" CAP + O-RING	2	PZ	VM1054A0	H7.8 PRESSURE REDUCER RING NUT	1	PZ
Code	Description	Qty	UOM																																						
VI1013A1	30.5X39.5X3 NYLON FLAT WASHER	1	PZ																																						
VI1220A1	4,2X12 TCB SELF-TAPPIN G SCREW	2	PZ																																						
VL1014A0	PRESSURE REDUCER WITH DISTRIBUTOR	1	PZ																																						
VL1014B0	PRESSURE REDUCER WITH DISTRIBUTOR	1	PZ																																						
VL1034C0	MESH WATER FILTER D10	1	PZ																																						
VL1062C0	PRESSURE REDUCER-FIL TER LOCKING FORK	1	PZ																																						
VM1053A0	1/8" CAP + O-RING	2	PZ																																						
VM1054A0	H7.8 PRESSURE REDUCER RING NUT	1	PZ																																						
RC1365A	3/4"-10 JG FEMALE CONNECTION		KRC1365A	3/4"-10 OR 8 JG FEMALE CONNECTION KI	<table border="1"> <thead> <tr> <th>Code</th> <th>Description</th> <th>Qty</th> <th>UOM</th> </tr> </thead> <tbody> <tr> <td>GN1200A1</td> <td>3/4 CONNECTION SEAL D=24 RUBBER+NET</td> <td>1</td> <td>PZ</td> </tr> <tr> <td>RC1002A0</td> <td>JG 10M-8F TERMINAL REDUCTION FITTING</td> <td>1</td> <td>PZ</td> </tr> <tr> <td>RC1365A0</td> <td>3/4"-10 JG FEMALE CONNECTION</td> <td>1</td> <td>PZ</td> </tr> </tbody> </table>	Code	Description	Qty	UOM	GN1200A1	3/4 CONNECTION SEAL D=24 RUBBER+NET	1	PZ	RC1002A0	JG 10M-8F TERMINAL REDUCTION FITTING	1	PZ	RC1365A0	3/4"-10 JG FEMALE CONNECTION	1	PZ																				
Code	Description	Qty	UOM																																						
GN1200A1	3/4 CONNECTION SEAL D=24 RUBBER+NET	1	PZ																																						
RC1002A0	JG 10M-8F TERMINAL REDUCTION FITTING	1	PZ																																						
RC1365A0	3/4"-10 JG FEMALE CONNECTION	1	PZ																																						
0H7472A	DISTRIBUTOR SUPPORT PLATE		KVL1117A	EUR MM 2016+LMT FILTER+PRESS. RED. KIT	<table border="1"> <thead> <tr> <th>Code</th> <th>Description</th> <th>Qty</th> <th>UOM</th> </tr> </thead> <tbody> <tr> <td>0H7472A1</td> <td>DISTRIBUTOR SUPPORT PLATE</td> <td>1</td> <td>PZ</td> </tr> <tr> <td>RC1004A0</td> <td>Ø10-Ø8-8 Y CONNECTION</td> <td>1</td> <td>PZ</td> </tr> <tr> <td>RC1243A0</td> <td>Ø10F-Ø10M ELBOW CONNECTION + JG END KIT</td> <td>1</td> <td>PZ</td> </tr> <tr> <td>RC1372A0</td> <td>Ø10M-1/4 M CIL. STRAIGHT FITTING</td> <td>2</td> <td>PZ</td> </tr> </tbody> </table>	Code	Description	Qty	UOM	0H7472A1	DISTRIBUTOR SUPPORT PLATE	1	PZ	RC1004A0	Ø10-Ø8-8 Y CONNECTION	1	PZ	RC1243A0	Ø10F-Ø10M ELBOW CONNECTION + JG END KIT	1	PZ	RC1372A0	Ø10M-1/4 M CIL. STRAIGHT FITTING	2	PZ																
Code	Description	Qty	UOM																																						
0H7472A1	DISTRIBUTOR SUPPORT PLATE	1	PZ																																						
RC1004A0	Ø10-Ø8-8 Y CONNECTION	1	PZ																																						
RC1243A0	Ø10F-Ø10M ELBOW CONNECTION + JG END KIT	1	PZ																																						
RC1372A0	Ø10M-1/4 M CIL. STRAIGHT FITTING	2	PZ																																						

COMPONENT			SPARE PART																																						
Code	Description	Image	Code	Description	Components list																																				
0H7472A	DISTRIBUTOR SUPPORT PLATE		KVL1117A	EUR MM 2016+LMT FILTER+PRESS. RED. KIT	<table border="1"> <thead> <tr> <th>Code</th> <th>Description</th> <th>Qty</th> <th>UOM</th> </tr> </thead> <tbody> <tr> <td>VI1013A1</td> <td>30.5X39.5X3 NYLON FLAT WASHER</td> <td>1</td> <td>PZ</td> </tr> <tr> <td>VI1220A1</td> <td>4,2X12 TCB SELF-TAPPIN G SCREW</td> <td>2</td> <td>PZ</td> </tr> <tr> <td>VL1014A0</td> <td>PRESSURE REDUCER WITH DISTRIBUTOR</td> <td>1</td> <td>PZ</td> </tr> <tr> <td>VL1014B0</td> <td>PRESSURE REDUCER WITH DISTRIBUTOR</td> <td>1</td> <td>PZ</td> </tr> <tr> <td>VL1034C0</td> <td>MESH WATER FILTER D10</td> <td>1</td> <td>PZ</td> </tr> <tr> <td>VL1062C0</td> <td>PRESSURE REDUCER-FIL TER LOCKING FORK</td> <td>1</td> <td>PZ</td> </tr> <tr> <td>VM1053A0</td> <td>1/8" CAP + O-RING</td> <td>2</td> <td>PZ</td> </tr> <tr> <td>VM1054A0</td> <td>H7.8 PRESSURE REDUCER RING NUT</td> <td>1</td> <td>PZ</td> </tr> </tbody> </table>	Code	Description	Qty	UOM	VI1013A1	30.5X39.5X3 NYLON FLAT WASHER	1	PZ	VI1220A1	4,2X12 TCB SELF-TAPPIN G SCREW	2	PZ	VL1014A0	PRESSURE REDUCER WITH DISTRIBUTOR	1	PZ	VL1014B0	PRESSURE REDUCER WITH DISTRIBUTOR	1	PZ	VL1034C0	MESH WATER FILTER D10	1	PZ	VL1062C0	PRESSURE REDUCER-FIL TER LOCKING FORK	1	PZ	VM1053A0	1/8" CAP + O-RING	2	PZ	VM1054A0	H7.8 PRESSURE REDUCER RING NUT	1	PZ
			Code	Description	Qty	UOM																																			
VI1013A1	30.5X39.5X3 NYLON FLAT WASHER	1	PZ																																						
VI1220A1	4,2X12 TCB SELF-TAPPIN G SCREW	2	PZ																																						
VL1014A0	PRESSURE REDUCER WITH DISTRIBUTOR	1	PZ																																						
VL1014B0	PRESSURE REDUCER WITH DISTRIBUTOR	1	PZ																																						
VL1034C0	MESH WATER FILTER D10	1	PZ																																						
VL1062C0	PRESSURE REDUCER-FIL TER LOCKING FORK	1	PZ																																						
VM1053A0	1/8" CAP + O-RING	2	PZ																																						
VM1054A0	H7.8 PRESSURE REDUCER RING NUT	1	PZ																																						
K0H7472A	DISTRIBUTOR SUPPORT PLATE KI	<table border="1"> <thead> <tr> <th>Code</th> <th>Description</th> <th>Qty</th> <th>UOM</th> </tr> </thead> <tbody> <tr> <td>0H7472A0</td> <td></td> <td>1</td> <td>PZ</td> </tr> <tr> <td>0H7472A1</td> <td>DISTRIBUTOR SUPPORT PLATE</td> <td>1</td> <td>PZ</td> </tr> </tbody> </table>	Code	Description	Qty	UOM	0H7472A0		1	PZ	0H7472A1	DISTRIBUTOR SUPPORT PLATE	1	PZ																											
Code	Description	Qty	UOM																																						
0H7472A0		1	PZ																																						
0H7472A1	DISTRIBUTOR SUPPORT PLATE	1	PZ																																						
RC1372A	Ø10M-1/4 M CIL. STRAIGHT FITTING		KVL1117A	EUR MM 2016+LMT FILTER+PRESS. RED. KIT	<table border="1"> <thead> <tr> <th>Code</th> <th>Description</th> <th>Qty</th> <th>UOM</th> </tr> </thead> <tbody> <tr> <td>0H7472A1</td> <td>DISTRIBUTOR SUPPORT PLATE</td> <td>1</td> <td>PZ</td> </tr> <tr> <td>RC1004A0</td> <td>Ø10-Ø8-8 Y CONNECTION</td> <td>1</td> <td>PZ</td> </tr> <tr> <td>RC1243A0</td> <td>Ø10F-Ø10M ELBOW CONNECTION + JG END KIT</td> <td>1</td> <td>PZ</td> </tr> <tr> <td>RC1372A0</td> <td>Ø10M-1/4 M CIL. STRAIGHT FITTING</td> <td>2</td> <td>PZ</td> </tr> <tr> <td>VI1013A1</td> <td>30.5X39.5X3 NYLON FLAT WASHER</td> <td>1</td> <td>PZ</td> </tr> <tr> <td>VI1220A1</td> <td>4,2X12 TCB SELF-TAPPIN G SCREW</td> <td>2</td> <td>PZ</td> </tr> </tbody> </table>	Code	Description	Qty	UOM	0H7472A1	DISTRIBUTOR SUPPORT PLATE	1	PZ	RC1004A0	Ø10-Ø8-8 Y CONNECTION	1	PZ	RC1243A0	Ø10F-Ø10M ELBOW CONNECTION + JG END KIT	1	PZ	RC1372A0	Ø10M-1/4 M CIL. STRAIGHT FITTING	2	PZ	VI1013A1	30.5X39.5X3 NYLON FLAT WASHER	1	PZ	VI1220A1	4,2X12 TCB SELF-TAPPIN G SCREW	2	PZ								
Code	Description	Qty	UOM																																						
0H7472A1	DISTRIBUTOR SUPPORT PLATE	1	PZ																																						
RC1004A0	Ø10-Ø8-8 Y CONNECTION	1	PZ																																						
RC1243A0	Ø10F-Ø10M ELBOW CONNECTION + JG END KIT	1	PZ																																						
RC1372A0	Ø10M-1/4 M CIL. STRAIGHT FITTING	2	PZ																																						
VI1013A1	30.5X39.5X3 NYLON FLAT WASHER	1	PZ																																						
VI1220A1	4,2X12 TCB SELF-TAPPIN G SCREW	2	PZ																																						



COMPONENT			SPARE PART																																										
Code	Description	Image	Code	Description	Components list																																								
RC1372A	Ø10M-1/4 M CIL. STRAIGHT FITTING		KVL1117A	EUR MM 2016+LMT FILTER+PRESS. RED. KIT	<table border="1"> <thead> <tr> <th>Code</th> <th>Description</th> <th>Qty</th> <th>UOM</th> </tr> </thead> <tbody> <tr> <td>VL1014A0</td> <td>PRESSURE REDUCER WITH DISTRIBUTOR</td> <td>1</td> <td>PZ</td> </tr> <tr> <td>VL1014B0</td> <td>PRESSURE REDUCER WITH DISTRIBUTOR</td> <td>1</td> <td>PZ</td> </tr> <tr> <td>VL1034C0</td> <td>MESH WATER FILTER D10</td> <td>1</td> <td>PZ</td> </tr> <tr> <td>VL1062C0</td> <td>PRESSURE REDUCER-FIL TER LOCKING FORK</td> <td>1</td> <td>PZ</td> </tr> <tr> <td>VM1053A0</td> <td>1/8" CAP + O-RING</td> <td>2</td> <td>PZ</td> </tr> <tr> <td>VM1054A0</td> <td>H7.8 PRESSURE REDUCER RING NUT</td> <td>1</td> <td>PZ</td> </tr> </tbody> </table>	Code	Description	Qty	UOM	VL1014A0	PRESSURE REDUCER WITH DISTRIBUTOR	1	PZ	VL1014B0	PRESSURE REDUCER WITH DISTRIBUTOR	1	PZ	VL1034C0	MESH WATER FILTER D10	1	PZ	VL1062C0	PRESSURE REDUCER-FIL TER LOCKING FORK	1	PZ	VM1053A0	1/8" CAP + O-RING	2	PZ	VM1054A0	H7.8 PRESSURE REDUCER RING NUT	1	PZ												
			Code	Description	Qty	UOM																																							
VL1014A0	PRESSURE REDUCER WITH DISTRIBUTOR	1	PZ																																										
VL1014B0	PRESSURE REDUCER WITH DISTRIBUTOR	1	PZ																																										
VL1034C0	MESH WATER FILTER D10	1	PZ																																										
VL1062C0	PRESSURE REDUCER-FIL TER LOCKING FORK	1	PZ																																										
VM1053A0	1/8" CAP + O-RING	2	PZ																																										
VM1054A0	H7.8 PRESSURE REDUCER RING NUT	1	PZ																																										
KRC1372A	D 10M-1/4 M CIL STRAIGHT CONNECTION KIT	<table border="1"> <thead> <tr> <th>Code</th> <th>Description</th> <th>Qty</th> <th>UOM</th> </tr> </thead> <tbody> <tr> <td>RC1372A0</td> <td>Ø10M-1/4 M CIL. STRAIGHT FITTING</td> <td>1</td> <td>PZ</td> </tr> </tbody> </table>	Code	Description	Qty	UOM	RC1372A0	Ø10M-1/4 M CIL. STRAIGHT FITTING	1	PZ																																			
Code	Description	Qty	UOM																																										
RC1372A0	Ø10M-1/4 M CIL. STRAIGHT FITTING	1	PZ																																										
VL1014B	PRESSURE REDUCER WITH DISTRIBUTOR		KVL1117A	EUR MM 2016+LMT FILTER+PRESS. RED. KIT	<table border="1"> <thead> <tr> <th>Code</th> <th>Description</th> <th>Qty</th> <th>UOM</th> </tr> </thead> <tbody> <tr> <td>0H7472A1</td> <td>DISTRIBUTOR SUPPORT PLATE</td> <td>1</td> <td>PZ</td> </tr> <tr> <td>RC1004A0</td> <td>Ø10-Ø8-8 Y CONNECTION</td> <td>1</td> <td>PZ</td> </tr> <tr> <td>RC1243A0</td> <td>Ø10F-Ø10M ELBOW CONNECTION + JG END KIT</td> <td>1</td> <td>PZ</td> </tr> <tr> <td>RC1372A0</td> <td>Ø10M-1/4 M CIL. STRAIGHT FITTING</td> <td>2</td> <td>PZ</td> </tr> <tr> <td>VI1013A1</td> <td>30.5X39.5X3 NYLON FLAT WASHER</td> <td>1</td> <td>PZ</td> </tr> <tr> <td>VI1220A1</td> <td>4,2X12 TCB SELF-TAPPIN G SCREW</td> <td>2</td> <td>PZ</td> </tr> <tr> <td>VL1014A0</td> <td>PRESSURE REDUCER WITH DISTRIBUTOR</td> <td>1</td> <td>PZ</td> </tr> <tr> <td>VL1014B0</td> <td>PRESSURE REDUCER WITH DISTRIBUTOR</td> <td>1</td> <td>PZ</td> </tr> <tr> <td>VL1034C0</td> <td>MESH WATER FILTER D10</td> <td>1</td> <td>PZ</td> </tr> </tbody> </table>	Code	Description	Qty	UOM	0H7472A1	DISTRIBUTOR SUPPORT PLATE	1	PZ	RC1004A0	Ø10-Ø8-8 Y CONNECTION	1	PZ	RC1243A0	Ø10F-Ø10M ELBOW CONNECTION + JG END KIT	1	PZ	RC1372A0	Ø10M-1/4 M CIL. STRAIGHT FITTING	2	PZ	VI1013A1	30.5X39.5X3 NYLON FLAT WASHER	1	PZ	VI1220A1	4,2X12 TCB SELF-TAPPIN G SCREW	2	PZ	VL1014A0	PRESSURE REDUCER WITH DISTRIBUTOR	1	PZ	VL1014B0	PRESSURE REDUCER WITH DISTRIBUTOR	1	PZ	VL1034C0	MESH WATER FILTER D10	1	PZ
			Code	Description	Qty	UOM																																							
			0H7472A1	DISTRIBUTOR SUPPORT PLATE	1	PZ																																							
			RC1004A0	Ø10-Ø8-8 Y CONNECTION	1	PZ																																							
			RC1243A0	Ø10F-Ø10M ELBOW CONNECTION + JG END KIT	1	PZ																																							
			RC1372A0	Ø10M-1/4 M CIL. STRAIGHT FITTING	2	PZ																																							
			VI1013A1	30.5X39.5X3 NYLON FLAT WASHER	1	PZ																																							
			VI1220A1	4,2X12 TCB SELF-TAPPIN G SCREW	2	PZ																																							
			VL1014A0	PRESSURE REDUCER WITH DISTRIBUTOR	1	PZ																																							
			VL1014B0	PRESSURE REDUCER WITH DISTRIBUTOR	1	PZ																																							
VL1034C0	MESH WATER FILTER D10	1	PZ																																										





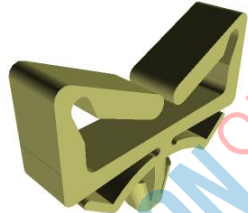
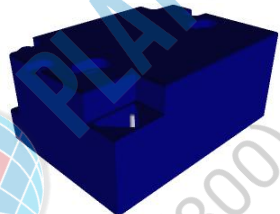

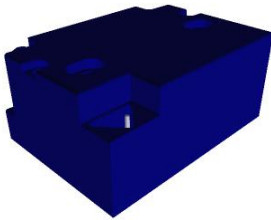
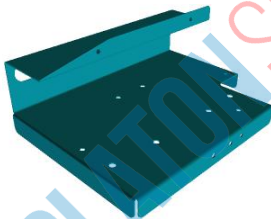
COMPONENT			SPARE PART																																							
Code	Description	Image	Code	Description	Components list																																					
VL1014B	PRESSURE REDUCER WITH DISTRIBUTOR		KVL1117A	EUR MM 2016+LMT FILTER+PRESS. RED. KIT	<table border="1"> <thead> <tr> <th>Code</th> <th>Description</th> <th>Qty</th> <th>UOM</th> </tr> </thead> <tbody> <tr> <td>VL1062C0</td> <td>PRESSURE REDUCER-FILTER LOCKING FORK</td> <td>1</td> <td>PZ</td> </tr> <tr> <td>VM1053A0</td> <td>1/8" CAP + O-RING</td> <td>2</td> <td>PZ</td> </tr> <tr> <td>VM1054A0</td> <td>H7.8 PRESSURE REDUCER RING NUT</td> <td>1</td> <td>PZ</td> </tr> </tbody> </table>	Code	Description	Qty	UOM	VL1062C0	PRESSURE REDUCER-FILTER LOCKING FORK	1	PZ	VM1053A0	1/8" CAP + O-RING	2	PZ	VM1054A0	H7.8 PRESSURE REDUCER RING NUT	1	PZ																					
			Code	Description	Qty	UOM																																				
			VL1062C0	PRESSURE REDUCER-FILTER LOCKING FORK	1	PZ																																				
VM1053A0	1/8" CAP + O-RING	2	PZ																																							
VM1054A0	H7.8 PRESSURE REDUCER RING NUT	1	PZ																																							
KVL1014B	MIND. MAPS PRESSURE REDUCER KIT	<table border="1"> <thead> <tr> <th>Code</th> <th>Description</th> <th>Qty</th> <th>UOM</th> </tr> </thead> <tbody> <tr> <td>EL1185A0</td> <td>Ø8F - Ø8F ELBOW CONNECTION</td> <td>1</td> <td>PZ</td> </tr> <tr> <td>RC1003A0</td> <td>8M-1/8 BSPP FITTING</td> <td>2</td> <td>PZ</td> </tr> <tr> <td>RC1372A0</td> <td>Ø10M-1/4 M CIL. STRAIGHT FITTING</td> <td>1</td> <td>PZ</td> </tr> <tr> <td>RC1396A0</td> <td>JG D10-1/4 STRAIGHT END FITTING</td> <td>1</td> <td>PZ</td> </tr> <tr> <td>VL1014B0</td> <td>PRESSURE REDUCER WITH DISTRIBUTOR</td> <td>1</td> <td>PZ</td> </tr> <tr> <td>VL1071A0</td> <td>PRESSURE REDUCER WITH DISTRIBUTOR</td> <td>1</td> <td>PZ</td> </tr> <tr> <td>VM1054A0</td> <td>H7.8 PRESSURE REDUCER RING NUT</td> <td>1</td> <td>PZ</td> </tr> <tr> <td>VM2028A0</td> <td>20X10X4 RUBBER WASHER</td> <td>1</td> <td>PZ</td> </tr> <tr> <td>VM2059A0</td> <td>1/4" CAP WITH O-RING SEAL</td> <td>1</td> <td>PZ</td> </tr> </tbody> </table>	Code	Description	Qty	UOM	EL1185A0	Ø8F - Ø8F ELBOW CONNECTION	1	PZ	RC1003A0	8M-1/8 BSPP FITTING	2	PZ	RC1372A0	Ø10M-1/4 M CIL. STRAIGHT FITTING	1	PZ	RC1396A0	JG D10-1/4 STRAIGHT END FITTING	1	PZ	VL1014B0	PRESSURE REDUCER WITH DISTRIBUTOR	1	PZ	VL1071A0	PRESSURE REDUCER WITH DISTRIBUTOR	1	PZ	VM1054A0	H7.8 PRESSURE REDUCER RING NUT	1	PZ	VM2028A0	20X10X4 RUBBER WASHER	1	PZ	VM2059A0	1/4" CAP WITH O-RING SEAL	1	PZ
Code	Description	Qty	UOM																																							
EL1185A0	Ø8F - Ø8F ELBOW CONNECTION	1	PZ																																							
RC1003A0	8M-1/8 BSPP FITTING	2	PZ																																							
RC1372A0	Ø10M-1/4 M CIL. STRAIGHT FITTING	1	PZ																																							
RC1396A0	JG D10-1/4 STRAIGHT END FITTING	1	PZ																																							
VL1014B0	PRESSURE REDUCER WITH DISTRIBUTOR	1	PZ																																							
VL1071A0	PRESSURE REDUCER WITH DISTRIBUTOR	1	PZ																																							
VM1054A0	H7.8 PRESSURE REDUCER RING NUT	1	PZ																																							
VM2028A0	20X10X4 RUBBER WASHER	1	PZ																																							
VM2059A0	1/4" CAP WITH O-RING SEAL	1	PZ																																							
KVL0014B	EUR 2017 MIND.MAPS PRESSURE REDUCER KIT	<table border="1"> <thead> <tr> <th>Code</th> <th>Description</th> <th>Qty</th> <th>UOM</th> </tr> </thead> <tbody> <tr> <td>RC1372A0</td> <td>Ø10M-1/4 M CIL. STRAIGHT FITTING</td> <td>1</td> <td>PZ</td> </tr> <tr> <td>RC1396A0</td> <td>JG D10-1/4 STRAIGHT END FITTING</td> <td>1</td> <td>PZ</td> </tr> <tr> <td>VL1014B0</td> <td>PRESSURE REDUCER WITH DISTRIBUTOR</td> <td>1</td> <td>PZ</td> </tr> <tr> <td>VM1054A0</td> <td>H7.8 PRESSURE REDUCER RING NUT</td> <td>1</td> <td>PZ</td> </tr> </tbody> </table>	Code	Description	Qty	UOM	RC1372A0	Ø10M-1/4 M CIL. STRAIGHT FITTING	1	PZ	RC1396A0	JG D10-1/4 STRAIGHT END FITTING	1	PZ	VL1014B0	PRESSURE REDUCER WITH DISTRIBUTOR	1	PZ	VM1054A0	H7.8 PRESSURE REDUCER RING NUT	1	PZ																				
Code	Description	Qty	UOM																																							
RC1372A0	Ø10M-1/4 M CIL. STRAIGHT FITTING	1	PZ																																							
RC1396A0	JG D10-1/4 STRAIGHT END FITTING	1	PZ																																							
VL1014B0	PRESSURE REDUCER WITH DISTRIBUTOR	1	PZ																																							
VM1054A0	H7.8 PRESSURE REDUCER RING NUT	1	PZ																																							

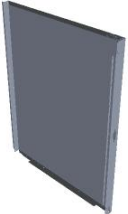

COMPONENT			SPARE PART																										
Code	Description	Image	Code	Description	Components list																								
VL1014B	PRESSURE REDUCER WITH DISTRIBUTOR		KVL0014A	EUR MIND.MAPS PRESSURE REDUCER KIT	<table border="1"> <thead> <tr> <th>Code</th> <th>Description</th> <th>Qty</th> <th>UOM</th> </tr> </thead> <tbody> <tr> <td>RC1372A0</td> <td>Ø10M-1/4 M CIL. STRAIGHT FITTING</td> <td>2</td> <td>PZ</td> </tr> <tr> <td>VL1014A0</td> <td>PRESSURE REDUCER WITH DISTRIBUTOR</td> <td>1</td> <td>PZ</td> </tr> <tr> <td>VL1014B0</td> <td>PRESSURE REDUCER WITH DISTRIBUTOR</td> <td>1</td> <td>PZ</td> </tr> <tr> <td>VM1053A0</td> <td>1/8" CAP + O-RING</td> <td>2</td> <td>PZ</td> </tr> <tr> <td>VM1054A0</td> <td>H7.8 PRESSURE REDUCER RING NUT</td> <td>1</td> <td>PZ</td> </tr> </tbody> </table>	Code	Description	Qty	UOM	RC1372A0	Ø10M-1/4 M CIL. STRAIGHT FITTING	2	PZ	VL1014A0	PRESSURE REDUCER WITH DISTRIBUTOR	1	PZ	VL1014B0	PRESSURE REDUCER WITH DISTRIBUTOR	1	PZ	VM1053A0	1/8" CAP + O-RING	2	PZ	VM1054A0	H7.8 PRESSURE REDUCER RING NUT	1	PZ
			Code	Description	Qty	UOM																							
RC1372A0	Ø10M-1/4 M CIL. STRAIGHT FITTING	2	PZ																										
VL1014A0	PRESSURE REDUCER WITH DISTRIBUTOR	1	PZ																										
VL1014B0	PRESSURE REDUCER WITH DISTRIBUTOR	1	PZ																										
VM1053A0	1/8" CAP + O-RING	2	PZ																										
VM1054A0	H7.8 PRESSURE REDUCER RING NUT	1	PZ																										
KVL0010A	S.4 - 5 WATER PRESSURE REDUCER KIT	<table border="1"> <thead> <tr> <th>Code</th> <th>Description</th> <th>Qty</th> <th>UOM</th> </tr> </thead> <tbody> <tr> <td>EL1210A0</td> <td>J. GUEST STRAIGHT END CONNECTION</td> <td>2</td> <td>PZ</td> </tr> <tr> <td>VL1014A0</td> <td>PRESSURE REDUCER WITH DISTRIBUTOR</td> <td>1</td> <td>PZ</td> </tr> <tr> <td>VL1014B0</td> <td>PRESSURE REDUCER WITH DISTRIBUTOR</td> <td>1</td> <td>PZ</td> </tr> <tr> <td>VM1053A0</td> <td>1/8" CAP + O-RING</td> <td>2</td> <td>PZ</td> </tr> </tbody> </table>	Code	Description	Qty	UOM	EL1210A0	J. GUEST STRAIGHT END CONNECTION	2	PZ	VL1014A0	PRESSURE REDUCER WITH DISTRIBUTOR	1	PZ	VL1014B0	PRESSURE REDUCER WITH DISTRIBUTOR	1	PZ	VM1053A0	1/8" CAP + O-RING	2	PZ							
Code	Description	Qty	UOM																										
EL1210A0	J. GUEST STRAIGHT END CONNECTION	2	PZ																										
VL1014A0	PRESSURE REDUCER WITH DISTRIBUTOR	1	PZ																										
VL1014B0	PRESSURE REDUCER WITH DISTRIBUTOR	1	PZ																										
VM1053A0	1/8" CAP + O-RING	2	PZ																										
ASM3121A	General overview		ASM3121A0	General overview																									
VE1115A	20 A 230V 4 POLES MINICONTACTOR		KVE1115A	20A 230V 4 POLES MINICONTACTOR KI	<table border="1"> <thead> <tr> <th>Code</th> <th>Description</th> <th>Qty</th> <th>UOM</th> </tr> </thead> <tbody> <tr> <td>VE1115A0</td> <td>20 A 230V 4 POLES MINICONTACT OR</td> <td>1</td> <td>PZ</td> </tr> <tr> <td>VM1075A1</td> <td>PLASTIC CLIP TO FIX CONTACTORS</td> <td>4</td> <td>PZ</td> </tr> </tbody> </table>	Code	Description	Qty	UOM	VE1115A0	20 A 230V 4 POLES MINICONTACT OR	1	PZ	VM1075A1	PLASTIC CLIP TO FIX CONTACTORS	4	PZ												
Code	Description	Qty	UOM																										
VE1115A0	20 A 230V 4 POLES MINICONTACT OR	1	PZ																										
VM1075A1	PLASTIC CLIP TO FIX CONTACTORS	4	PZ																										

COMPONENT			SPARE PART																																																						
Code	Description	Image	Code	Description	Components list																																																				
VM1056A	SMALL CONTACTOR BRACKET VE1115A		VM1056A0	SMALL CONTACTOR BRACKET VE1115A																																																					
VM1066A	SADDLE CLIP FOR CABLES PASSING		VM1066A0	SADDLE CLIP FOR CABLES PASSING																																																					
VE1625A	5E SERIES GAS LIGHTER		KVE0009B	EUROPE VERSION GAS IGNITER KIT	<table border="1"> <thead> <tr> <th>Code</th> <th>Description</th> <th>Qty</th> <th>UOM</th> </tr> </thead> <tbody> <tr> <td>0H5126A0</td> <td>IGNITER FIXING OMEG</td> <td>1</td> <td>PZ</td> </tr> <tr> <td>0H6825A0</td> <td>METAL CLAMP</td> <td>1</td> <td>PZ</td> </tr> <tr> <td>CE1390A0</td> <td>YELLOW CABLE UNIP RUBB.SIL. Ø 0,75 MMQ</td> <td>0.260</td> <td>M</td> </tr> <tr> <td>CE1395A0</td> <td>6,3 X 0,8 MALE FASTO</td> <td>4</td> <td>PZ</td> </tr> <tr> <td>CE1661A0</td> <td>MALE FASTON COVER 6,3X0,</td> <td>4</td> <td>PZ</td> </tr> <tr> <td>CE1777A0</td> <td>HV L=650 STARTER FIDA CABLE</td> <td>2</td> <td>PZ</td> </tr> <tr> <td>CE1777A1</td> <td>HV START UP CABLE L=700 WITH SILICON CAP</td> <td>2</td> <td>PZ</td> </tr> <tr> <td>CE1782A0</td> <td>HV L=300 BRIDGE FIDA CABLE</td> <td>1</td> <td>PZ</td> </tr> <tr> <td>CE1783A0</td> <td>HIGH VOLTAGE BRIDGE CABLE L=600</td> <td>1</td> <td>PZ</td> </tr> <tr> <td>CE1792A0</td> <td>FLAME DETECTOR CANDLE CABL</td> <td>1</td> <td>PZ</td> </tr> <tr> <td>CE1811A1</td> <td>LIGHTER CONNECTING CABLE PLUG 90°</td> <td>1</td> <td>PZ</td> </tr> <tr> <td>GN1328A1</td> <td>BACK BLACK ADESIVE GASKET 8X3</td> <td>0.500</td> <td>M</td> </tr> </tbody> </table>	Code	Description	Qty	UOM	0H5126A0	IGNITER FIXING OMEG	1	PZ	0H6825A0	METAL CLAMP	1	PZ	CE1390A0	YELLOW CABLE UNIP RUBB.SIL. Ø 0,75 MMQ	0.260	M	CE1395A0	6,3 X 0,8 MALE FASTO	4	PZ	CE1661A0	MALE FASTON COVER 6,3X0,	4	PZ	CE1777A0	HV L=650 STARTER FIDA CABLE	2	PZ	CE1777A1	HV START UP CABLE L=700 WITH SILICON CAP	2	PZ	CE1782A0	HV L=300 BRIDGE FIDA CABLE	1	PZ	CE1783A0	HIGH VOLTAGE BRIDGE CABLE L=600	1	PZ	CE1792A0	FLAME DETECTOR CANDLE CABL	1	PZ	CE1811A1	LIGHTER CONNECTING CABLE PLUG 90°	1	PZ	GN1328A1	BACK BLACK ADESIVE GASKET 8X3	0.500	M
Code	Description	Qty	UOM																																																						
0H5126A0	IGNITER FIXING OMEG	1	PZ																																																						
0H6825A0	METAL CLAMP	1	PZ																																																						
CE1390A0	YELLOW CABLE UNIP RUBB.SIL. Ø 0,75 MMQ	0.260	M																																																						
CE1395A0	6,3 X 0,8 MALE FASTO	4	PZ																																																						
CE1661A0	MALE FASTON COVER 6,3X0,	4	PZ																																																						
CE1777A0	HV L=650 STARTER FIDA CABLE	2	PZ																																																						
CE1777A1	HV START UP CABLE L=700 WITH SILICON CAP	2	PZ																																																						
CE1782A0	HV L=300 BRIDGE FIDA CABLE	1	PZ																																																						
CE1783A0	HIGH VOLTAGE BRIDGE CABLE L=600	1	PZ																																																						
CE1792A0	FLAME DETECTOR CANDLE CABL	1	PZ																																																						
CE1811A1	LIGHTER CONNECTING CABLE PLUG 90°	1	PZ																																																						
GN1328A1	BACK BLACK ADESIVE GASKET 8X3	0.500	M																																																						

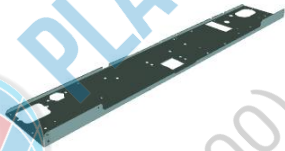
COMPONENT			SPARE PART																						
Code	Description	Image	Code	Description	Components list																				
VE1625A	5E SERIES GAS LIGHTER		KVE0009B	EUROPE VERSION GAS IGNITER KIT	<table border="1"> <thead> <tr> <th>Code</th> <th>Description</th> <th>Qty</th> <th>UOM</th> </tr> </thead> <tbody> <tr> <td>VE1625A0</td> <td>5E SERIES GAS LIGHTER</td> <td>1</td> <td>PZ</td> </tr> <tr> <td>VI1220A1</td> <td>4,2X12 TCB SELF-TAPPIN G SCREW</td> <td>2</td> <td>PZ</td> </tr> <tr> <td>VI1950A0</td> <td>ST. STEEL 4,2X13 TCB SELF-DRILLIN G SCREW</td> <td>1</td> <td>PZ</td> </tr> <tr> <td>VM1255A1</td> <td>THREAD-COV ERING CAP MARUTEX</td> <td>1</td> <td>PZ</td> </tr> </tbody> </table>	Code	Description	Qty	UOM	VE1625A0	5E SERIES GAS LIGHTER	1	PZ	VI1220A1	4,2X12 TCB SELF-TAPPIN G SCREW	2	PZ	VI1950A0	ST. STEEL 4,2X13 TCB SELF-DRILLIN G SCREW	1	PZ	VM1255A1	THREAD-COV ERING CAP MARUTEX	1	PZ
Code	Description	Qty	UOM																						
VE1625A0	5E SERIES GAS LIGHTER	1	PZ																						
VI1220A1	4,2X12 TCB SELF-TAPPIN G SCREW	2	PZ																						
VI1950A0	ST. STEEL 4,2X13 TCB SELF-DRILLIN G SCREW	1	PZ																						
VM1255A1	THREAD-COV ERING CAP MARUTEX	1	PZ																						
0H7810A	SUPPORT PLATE DOUBLE LIGHTER		K0H7493B	DOUBLE IGNITER HOLDING PLATE KIT	<table border="1"> <thead> <tr> <th>Code</th> <th>Description</th> <th>Qty</th> <th>UOM</th> </tr> </thead> <tbody> <tr> <td>0H7493B0</td> <td>VE1625A DOUBLE IGNITER STOPPING PLATE</td> <td>1</td> <td>PZ</td> </tr> </tbody> </table>	Code	Description	Qty	UOM	0H7493B0	VE1625A DOUBLE IGNITER STOPPING PLATE	1	PZ												
Code	Description	Qty	UOM																						
0H7493B0	VE1625A DOUBLE IGNITER STOPPING PLATE	1	PZ																						
0E1353B	XEBC GAS OVEN EXT. BOTTOM PANE		0E1353B1	XEBC GAS OVEN EXT. BOTTOM PANE																					
0D2310A																									
0D2311A																									



COMPONENT			SPARE PART																																										
Code	Description	Image	Code	Description	Components list																																								
0D2316B	XEBC GAS OVEN EXTERNAL FRONT BACK COVER		0D2316B0	XEBC GAS OVEN EXTERNAL FRONT BACK COVER																																									
0F1510B	XEBC-10EU-G BACK PANEL																																												
0H7276A	XEBC GAS PREMIX SUPPORT BEAM		0H7276A2	XEBC GAS PREMIX SUPPORT BEAM																																									
VL1067A	WASHING SYSTEM INLETS DISTRIBUTO		KVL1073A	EUR 1 ROTOR ARM PLUS CHEMICAL PUMP KIT	<table border="1"> <thead> <tr> <th>Code</th> <th>Description</th> <th>Qty</th> <th>UOM</th> </tr> </thead> <tbody> <tr> <td>GN1526A0</td> <td>INT. D.=6.9 TH=1.8 O-RIN</td> <td>1</td> <td>PZ</td> </tr> <tr> <td>RC1019A0</td> <td>D=10 ELASTIC CLAMP</td> <td>4</td> <td>PZ</td> </tr> <tr> <td>RC1130A0</td> <td>130X2,6 CLAM</td> <td>1</td> <td>PZ</td> </tr> <tr> <td>RC1242A0</td> <td>D=10 CLOSED CAP</td> <td>2</td> <td>PZ</td> </tr> <tr> <td>RC1408A0</td> <td>DOUBLE WIRE SPRING CLAMP D10.8 ZN</td> <td>2</td> <td>PZ</td> </tr> <tr> <td>TB2820A0</td> <td>PIPE EPDM FOR WASHING SYSTEM</td> <td>0.120</td> <td>M</td> </tr> <tr> <td>VL1019A0</td> <td>VIBRATION PUMP</td> <td>1</td> <td>PZ</td> </tr> <tr> <td>VL1064A0</td> <td>WASHING SYSTEM OUTLETS DISTRIBUTOR</td> <td>1</td> <td>PZ</td> </tr> <tr> <td>VL1067A0</td> <td>WASHING SYSTEM INLETS DISTRIBUTOR</td> <td>1</td> <td>PZ</td> </tr> </tbody> </table>	Code	Description	Qty	UOM	GN1526A0	INT. D.=6.9 TH=1.8 O-RIN	1	PZ	RC1019A0	D=10 ELASTIC CLAMP	4	PZ	RC1130A0	130X2,6 CLAM	1	PZ	RC1242A0	D=10 CLOSED CAP	2	PZ	RC1408A0	DOUBLE WIRE SPRING CLAMP D10.8 ZN	2	PZ	TB2820A0	PIPE EPDM FOR WASHING SYSTEM	0.120	M	VL1019A0	VIBRATION PUMP	1	PZ	VL1064A0	WASHING SYSTEM OUTLETS DISTRIBUTOR	1	PZ	VL1067A0	WASHING SYSTEM INLETS DISTRIBUTOR	1	PZ
Code	Description	Qty	UOM																																										
GN1526A0	INT. D.=6.9 TH=1.8 O-RIN	1	PZ																																										
RC1019A0	D=10 ELASTIC CLAMP	4	PZ																																										
RC1130A0	130X2,6 CLAM	1	PZ																																										
RC1242A0	D=10 CLOSED CAP	2	PZ																																										
RC1408A0	DOUBLE WIRE SPRING CLAMP D10.8 ZN	2	PZ																																										
TB2820A0	PIPE EPDM FOR WASHING SYSTEM	0.120	M																																										
VL1019A0	VIBRATION PUMP	1	PZ																																										
VL1064A0	WASHING SYSTEM OUTLETS DISTRIBUTOR	1	PZ																																										
VL1067A0	WASHING SYSTEM INLETS DISTRIBUTOR	1	PZ																																										

COMPONENT			SPARE PART																																																														
Code	Description	Image	Code	Description	Components list																																																												
VL1067A	WASHING SYSTEM INLETS DISTRIBUTO		KVL1073A	EUR 1 ROTOR ARM PLUS CHEMICAL PUMP KIT	<table border="1"> <thead> <tr> <th>Code</th> <th>Description</th> <th>Qty</th> <th>UOM</th> </tr> </thead> <tbody> <tr> <td>VL1081A0</td> <td>D6 BARBED NO RETURN VALVE</td> <td>1</td> <td>PZ</td> </tr> <tr> <td>VL1128A0</td> <td>BARBED CHECK VALVE D6</td> <td>1</td> <td>PZ</td> </tr> <tr> <td>VM2172A0</td> <td>PUMP LOCKING CLIP</td> <td>1</td> <td>PZ</td> </tr> </tbody> </table>	Code	Description	Qty	UOM	VL1081A0	D6 BARBED NO RETURN VALVE	1	PZ	VL1128A0	BARBED CHECK VALVE D6	1	PZ	VM2172A0	PUMP LOCKING CLIP	1	PZ																																												
Code	Description	Qty	UOM																																																														
VL1081A0	D6 BARBED NO RETURN VALVE	1	PZ																																																														
VL1128A0	BARBED CHECK VALVE D6	1	PZ																																																														
VM2172A0	PUMP LOCKING CLIP	1	PZ																																																														
VL1019A	VIBRATION PUMP		KVL1120A	USA COMPACT PLUS CLEANING SYSTEM KIT	<table border="1"> <thead> <tr> <th>Code</th> <th>Description</th> <th>Qty</th> <th>UOM</th> </tr> </thead> <tbody> <tr> <td>0H7553D0</td> <td>XECC PLUS WASHING SYSTEM PLAT</td> <td>1</td> <td>PZ</td> </tr> <tr> <td>EL1422A1</td> <td>1 WAY SOLENOID VALVE + D8-D10 REDUCTION</td> <td>1</td> <td>PZ</td> </tr> <tr> <td>EL1426A0</td> <td>H2O UL SOLENOID JG D8-PIPE HOLDER</td> <td>1</td> <td>PZ</td> </tr> <tr> <td>EL1437A0</td> <td>H2O SOLENOID JG D6 UL CHECK VALVE</td> <td>1</td> <td>PZ</td> </tr> <tr> <td>GN1312A0</td> <td>RUBBER CABLE-PASSI NG DE=26 DI=15 SP=10</td> <td>1</td> <td>PZ</td> </tr> <tr> <td>GN1526A0</td> <td>INT. D.=6.9 TH=1.8 O-RIN</td> <td>1</td> <td>PZ</td> </tr> <tr> <td>RC1019A0</td> <td>D=10 ELASTIC CLAMP</td> <td>8</td> <td>PZ</td> </tr> <tr> <td>RC1242A0</td> <td>D=10 CLOSED CAP</td> <td>2</td> <td>PZ</td> </tr> <tr> <td>RC1356A0</td> <td>STRAIGHT THREADED FEMALE END 8X1/4" BSP</td> <td>1</td> <td>PZ</td> </tr> <tr> <td>RC1408A0</td> <td>DOUBLE WIRE SPRING CLAMP D10.8 ZN</td> <td>2</td> <td>PZ</td> </tr> <tr> <td>TB2820A0</td> <td>PIPE EPDM FOR WASHING SYSTEM</td> <td>1.200</td> <td>M</td> </tr> <tr> <td>VI1220A1</td> <td>4,2X12 TCB SELF-TAPPIN G SCREW</td> <td>9</td> <td>PZ</td> </tr> <tr> <td>VL1019A0</td> <td>VIBRATION PUMP</td> <td>1</td> <td>PZ</td> </tr> <tr> <td>VL1054B0</td> <td>ONE WASHING SYS INLET DISTRIBUTOR</td> <td>1</td> <td>PZ</td> </tr> </tbody> </table>	Code	Description	Qty	UOM	0H7553D0	XECC PLUS WASHING SYSTEM PLAT	1	PZ	EL1422A1	1 WAY SOLENOID VALVE + D8-D10 REDUCTION	1	PZ	EL1426A0	H2O UL SOLENOID JG D8-PIPE HOLDER	1	PZ	EL1437A0	H2O SOLENOID JG D6 UL CHECK VALVE	1	PZ	GN1312A0	RUBBER CABLE-PASSI NG DE=26 DI=15 SP=10	1	PZ	GN1526A0	INT. D.=6.9 TH=1.8 O-RIN	1	PZ	RC1019A0	D=10 ELASTIC CLAMP	8	PZ	RC1242A0	D=10 CLOSED CAP	2	PZ	RC1356A0	STRAIGHT THREADED FEMALE END 8X1/4" BSP	1	PZ	RC1408A0	DOUBLE WIRE SPRING CLAMP D10.8 ZN	2	PZ	TB2820A0	PIPE EPDM FOR WASHING SYSTEM	1.200	M	VI1220A1	4,2X12 TCB SELF-TAPPIN G SCREW	9	PZ	VL1019A0	VIBRATION PUMP	1	PZ	VL1054B0	ONE WASHING SYS INLET DISTRIBUTOR	1	PZ
Code	Description	Qty	UOM																																																														
0H7553D0	XECC PLUS WASHING SYSTEM PLAT	1	PZ																																																														
EL1422A1	1 WAY SOLENOID VALVE + D8-D10 REDUCTION	1	PZ																																																														
EL1426A0	H2O UL SOLENOID JG D8-PIPE HOLDER	1	PZ																																																														
EL1437A0	H2O SOLENOID JG D6 UL CHECK VALVE	1	PZ																																																														
GN1312A0	RUBBER CABLE-PASSI NG DE=26 DI=15 SP=10	1	PZ																																																														
GN1526A0	INT. D.=6.9 TH=1.8 O-RIN	1	PZ																																																														
RC1019A0	D=10 ELASTIC CLAMP	8	PZ																																																														
RC1242A0	D=10 CLOSED CAP	2	PZ																																																														
RC1356A0	STRAIGHT THREADED FEMALE END 8X1/4" BSP	1	PZ																																																														
RC1408A0	DOUBLE WIRE SPRING CLAMP D10.8 ZN	2	PZ																																																														
TB2820A0	PIPE EPDM FOR WASHING SYSTEM	1.200	M																																																														
VI1220A1	4,2X12 TCB SELF-TAPPIN G SCREW	9	PZ																																																														
VL1019A0	VIBRATION PUMP	1	PZ																																																														
VL1054B0	ONE WASHING SYS INLET DISTRIBUTOR	1	PZ																																																														

COMPONENT			SPARE PART																																															
Code	Description	Image	Code	Description	Components list																																													
VL1019A	VIBRATION PUMP		KVL1120A	USA COMPACT PLUS CLEANING SYSTEM KIT	<table border="1"> <thead> <tr> <th>Code</th> <th>Description</th> <th>Qty</th> <th>UOM</th> </tr> </thead> <tbody> <tr> <td>VL1064A0</td> <td>WASHING SYSTEM OUTLETS DISTRIBUTOR</td> <td>1</td> <td>PZ</td> </tr> <tr> <td>VL1065A1</td> <td>1/4 MALE N.O. PRESSURE SWITCH</td> <td>1</td> <td>PZ</td> </tr> <tr> <td>VL1081A0</td> <td>D6 BARBED NO RETURN VALVE</td> <td>1</td> <td>PZ</td> </tr> <tr> <td>VL1102A0</td> <td></td> <td>1</td> <td>PZ</td> </tr> <tr> <td>VL1102A1</td> <td>DETERGENT LINE FILTER + BARBED VNR 6 MM</td> <td>1</td> <td>PZ</td> </tr> <tr> <td>VL1128A0</td> <td>BARBED CHECK VALVE D6</td> <td>1</td> <td>PZ</td> </tr> <tr> <td>VM2172A0</td> <td>PUMP LOCKING CLIP</td> <td>1</td> <td>PZ</td> </tr> </tbody> </table>	Code	Description	Qty	UOM	VL1064A0	WASHING SYSTEM OUTLETS DISTRIBUTOR	1	PZ	VL1065A1	1/4 MALE N.O. PRESSURE SWITCH	1	PZ	VL1081A0	D6 BARBED NO RETURN VALVE	1	PZ	VL1102A0		1	PZ	VL1102A1	DETERGENT LINE FILTER + BARBED VNR 6 MM	1	PZ	VL1128A0	BARBED CHECK VALVE D6	1	PZ	VM2172A0	PUMP LOCKING CLIP	1	PZ													
			Code	Description	Qty	UOM																																												
VL1064A0	WASHING SYSTEM OUTLETS DISTRIBUTOR	1	PZ																																															
VL1065A1	1/4 MALE N.O. PRESSURE SWITCH	1	PZ																																															
VL1081A0	D6 BARBED NO RETURN VALVE	1	PZ																																															
VL1102A0		1	PZ																																															
VL1102A1	DETERGENT LINE FILTER + BARBED VNR 6 MM	1	PZ																																															
VL1128A0	BARBED CHECK VALVE D6	1	PZ																																															
VM2172A0	PUMP LOCKING CLIP	1	PZ																																															
KVL1119A	EUR PLUS COMPACT CLEANING SYSTEM KIT	<table border="1"> <thead> <tr> <th>Code</th> <th>Description</th> <th>Qty</th> <th>UOM</th> </tr> </thead> <tbody> <tr> <td>0H7553C0</td> <td>XECC PLUS WASHING SYSTEM PLAT</td> <td>1</td> <td>PZ</td> </tr> <tr> <td>0H7553D0</td> <td>XECC PLUS WASHING SYSTEM PLAT</td> <td>1</td> <td>PZ</td> </tr> <tr> <td>EL1252A1</td> <td>1 WAY WATER VALVE + J.G. CONNECTION</td> <td>1</td> <td>PZ</td> </tr> <tr> <td>EL1424A0</td> <td>D8 CONNECTION WATER SOLENOID VALVE</td> <td>1</td> <td>PZ</td> </tr> <tr> <td>EL1436A0</td> <td>H2O SOLENOID JG D8 CHECK VALVE</td> <td>1</td> <td>PZ</td> </tr> <tr> <td>GN1312A0</td> <td>RUBBER CABLE-PASSI NG DE=26 DI=15 SP=10</td> <td>1</td> <td>PZ</td> </tr> <tr> <td>GN1526A0</td> <td>INT. D.=6.9 TH=1.8 O-RIN</td> <td>1</td> <td>PZ</td> </tr> <tr> <td>RC1006A0</td> <td>D8 PET PIPE GUIDE BEND</td> <td>2</td> <td>PZ</td> </tr> <tr> <td>RC1019A0</td> <td>D=10 ELASTIC CLAMP</td> <td>9</td> <td>PZ</td> </tr> <tr> <td>RC1242A0</td> <td>D=10 CLOSED CAP</td> <td>2</td> <td>PZ</td> </tr> <tr> <td>RC1356A0</td> <td>STRAIGHT THREADED FEMALE END 8X1/4" BSP</td> <td>1</td> <td>PZ</td> </tr> </tbody> </table>	Code	Description	Qty	UOM	0H7553C0	XECC PLUS WASHING SYSTEM PLAT	1	PZ	0H7553D0	XECC PLUS WASHING SYSTEM PLAT	1	PZ	EL1252A1	1 WAY WATER VALVE + J.G. CONNECTION	1	PZ	EL1424A0	D8 CONNECTION WATER SOLENOID VALVE	1	PZ	EL1436A0	H2O SOLENOID JG D8 CHECK VALVE	1	PZ	GN1312A0	RUBBER CABLE-PASSI NG DE=26 DI=15 SP=10	1	PZ	GN1526A0	INT. D.=6.9 TH=1.8 O-RIN	1	PZ	RC1006A0	D8 PET PIPE GUIDE BEND	2	PZ	RC1019A0	D=10 ELASTIC CLAMP	9	PZ	RC1242A0	D=10 CLOSED CAP	2	PZ	RC1356A0	STRAIGHT THREADED FEMALE END 8X1/4" BSP	1	PZ
Code	Description	Qty	UOM																																															
0H7553C0	XECC PLUS WASHING SYSTEM PLAT	1	PZ																																															
0H7553D0	XECC PLUS WASHING SYSTEM PLAT	1	PZ																																															
EL1252A1	1 WAY WATER VALVE + J.G. CONNECTION	1	PZ																																															
EL1424A0	D8 CONNECTION WATER SOLENOID VALVE	1	PZ																																															
EL1436A0	H2O SOLENOID JG D8 CHECK VALVE	1	PZ																																															
GN1312A0	RUBBER CABLE-PASSI NG DE=26 DI=15 SP=10	1	PZ																																															
GN1526A0	INT. D.=6.9 TH=1.8 O-RIN	1	PZ																																															
RC1006A0	D8 PET PIPE GUIDE BEND	2	PZ																																															
RC1019A0	D=10 ELASTIC CLAMP	9	PZ																																															
RC1242A0	D=10 CLOSED CAP	2	PZ																																															
RC1356A0	STRAIGHT THREADED FEMALE END 8X1/4" BSP	1	PZ																																															

COMPONENT			SPARE PART																																																																		
Code	Description	Image	Code	Description	Components list																																																																
VL1019A	VIBRATION PUMP		KVL1119A	EUR PLUS COMPACT CLEANING SYSTEM KIT	<table border="1"> <thead> <tr> <th>Code</th> <th>Description</th> <th>Qty</th> <th>UOM</th> </tr> </thead> <tbody> <tr> <td>RC1408A0</td> <td>DOUBLE WIRE SPRING CLAMP D10.8 ZN</td> <td>2</td> <td>PZ</td> </tr> <tr> <td>TB1818A0</td> <td>8X4.75 BLUE PE WATER INLET PIPE</td> <td>0.680</td> <td>M</td> </tr> <tr> <td>TB2820A0</td> <td>PIPE EPDM FOR WASHING SYSTEM</td> <td>1.700</td> <td>M</td> </tr> <tr> <td>V11220A1</td> <td>4,2X12 TCB SELF-TAPPIN G SCREW</td> <td>10</td> <td>PZ</td> </tr> <tr> <td>VL1019A0</td> <td>VIBRATION PUMP</td> <td>1</td> <td>PZ</td> </tr> <tr> <td>VL1054B0</td> <td>ONE WASHING SYS INLET DISTRIBUTOR</td> <td>1</td> <td>PZ</td> </tr> <tr> <td>VL1064A0</td> <td>WASHING SYSTEM OUTLETS DISTRIBUTOR</td> <td>1</td> <td>PZ</td> </tr> <tr> <td>VL1065A1</td> <td>1/4 MALE N.O. PRESSURE SWITCH</td> <td>1</td> <td>PZ</td> </tr> <tr> <td>VL1081A0</td> <td>D6 BARBED NO RETURN VALVE</td> <td>1</td> <td>PZ</td> </tr> <tr> <td>VL1083A0</td> <td>D=10 CONNECTION - D=6 PIPE FITTING</td> <td>1</td> <td>PZ</td> </tr> <tr> <td>VL1102A0</td> <td></td> <td>1</td> <td>PZ</td> </tr> <tr> <td>VL1102A1</td> <td>DETERGENT LINE FILTER + BARBED VNR 6 MM</td> <td>1</td> <td>PZ</td> </tr> <tr> <td>VL1128A0</td> <td>BARBED CHECK VALVE D6</td> <td>1</td> <td>PZ</td> </tr> <tr> <td>VM1610A0</td> <td>CLIP TWIST LOCK DIAM. 7,6-10,2 MM</td> <td>3</td> <td>PZ</td> </tr> <tr> <td>VM2172A0</td> <td>PUMP LOCKING CLIP</td> <td>1</td> <td>PZ</td> </tr> </tbody> </table>	Code	Description	Qty	UOM	RC1408A0	DOUBLE WIRE SPRING CLAMP D10.8 ZN	2	PZ	TB1818A0	8X4.75 BLUE PE WATER INLET PIPE	0.680	M	TB2820A0	PIPE EPDM FOR WASHING SYSTEM	1.700	M	V11220A1	4,2X12 TCB SELF-TAPPIN G SCREW	10	PZ	VL1019A0	VIBRATION PUMP	1	PZ	VL1054B0	ONE WASHING SYS INLET DISTRIBUTOR	1	PZ	VL1064A0	WASHING SYSTEM OUTLETS DISTRIBUTOR	1	PZ	VL1065A1	1/4 MALE N.O. PRESSURE SWITCH	1	PZ	VL1081A0	D6 BARBED NO RETURN VALVE	1	PZ	VL1083A0	D=10 CONNECTION - D=6 PIPE FITTING	1	PZ	VL1102A0		1	PZ	VL1102A1	DETERGENT LINE FILTER + BARBED VNR 6 MM	1	PZ	VL1128A0	BARBED CHECK VALVE D6	1	PZ	VM1610A0	CLIP TWIST LOCK DIAM. 7,6-10,2 MM	3	PZ	VM2172A0	PUMP LOCKING CLIP	1	PZ
Code	Description	Qty	UOM																																																																		
RC1408A0	DOUBLE WIRE SPRING CLAMP D10.8 ZN	2	PZ																																																																		
TB1818A0	8X4.75 BLUE PE WATER INLET PIPE	0.680	M																																																																		
TB2820A0	PIPE EPDM FOR WASHING SYSTEM	1.700	M																																																																		
V11220A1	4,2X12 TCB SELF-TAPPIN G SCREW	10	PZ																																																																		
VL1019A0	VIBRATION PUMP	1	PZ																																																																		
VL1054B0	ONE WASHING SYS INLET DISTRIBUTOR	1	PZ																																																																		
VL1064A0	WASHING SYSTEM OUTLETS DISTRIBUTOR	1	PZ																																																																		
VL1065A1	1/4 MALE N.O. PRESSURE SWITCH	1	PZ																																																																		
VL1081A0	D6 BARBED NO RETURN VALVE	1	PZ																																																																		
VL1083A0	D=10 CONNECTION - D=6 PIPE FITTING	1	PZ																																																																		
VL1102A0		1	PZ																																																																		
VL1102A1	DETERGENT LINE FILTER + BARBED VNR 6 MM	1	PZ																																																																		
VL1128A0	BARBED CHECK VALVE D6	1	PZ																																																																		
VM1610A0	CLIP TWIST LOCK DIAM. 7,6-10,2 MM	3	PZ																																																																		
VM2172A0	PUMP LOCKING CLIP	1	PZ																																																																		
			KVL1118A	EUR COMPACT ONE CLEANING SYSTEM KIT	<table border="1"> <thead> <tr> <th>Code</th> <th>Description</th> <th>Qty</th> <th>UOM</th> </tr> </thead> <tbody> <tr> <td>0H7173C0</td> <td>XECC ONE WASHING SYSTEM PLAT</td> <td>1</td> <td>PZ</td> </tr> <tr> <td>EL1436A0</td> <td>H2O SOLENOID J.G D8 CHECK VALVE</td> <td>1</td> <td>PZ</td> </tr> </tbody> </table>	Code	Description	Qty	UOM	0H7173C0	XECC ONE WASHING SYSTEM PLAT	1	PZ	EL1436A0	H2O SOLENOID J.G D8 CHECK VALVE	1	PZ																																																				
Code	Description	Qty	UOM																																																																		
0H7173C0	XECC ONE WASHING SYSTEM PLAT	1	PZ																																																																		
EL1436A0	H2O SOLENOID J.G D8 CHECK VALVE	1	PZ																																																																		

COMPONENT			SPARE PART																																																														
Code	Description	Image	Code	Description	Components list																																																												
VL1019A	VIBRATION PUMP		KVL1118A	EUR COMPACT ONE CLEANING SYSTEM KIT	<table border="1"> <thead> <tr> <th>Code</th> <th>Description</th> <th>Qty</th> <th>UOM</th> </tr> </thead> <tbody> <tr> <td>GN1526A0</td> <td>INT. D.=6.9 TH=1.8 O-RIN</td> <td>1</td> <td>PZ</td> </tr> <tr> <td>RC1019A0</td> <td>D=10 ELASTIC CLAMP</td> <td>10</td> <td>PZ</td> </tr> <tr> <td>RC1242A0</td> <td>D=10 CLOSED CAP</td> <td>2</td> <td>PZ</td> </tr> <tr> <td>RC1408A0</td> <td>DOUBLE WIRE SPRING CLAMP D10.8 ZN</td> <td>2</td> <td>PZ</td> </tr> <tr> <td>TB2820A0</td> <td>PIPE EPDM FOR WASHING SYSTEM</td> <td>1.200</td> <td>M</td> </tr> <tr> <td>VI1220A1</td> <td>4,2X12 TCB SELF-TAPPIN G SCREW</td> <td>6</td> <td>PZ</td> </tr> <tr> <td>VL1019A0</td> <td>VIBRATION PUMP</td> <td>1</td> <td>PZ</td> </tr> <tr> <td>VL1053B0</td> <td>ONE WASHING SYS EXT DISTRIBUTOR</td> <td>1</td> <td>PZ</td> </tr> <tr> <td>VL1054B0</td> <td>ONE WASHING SYS INLET DISTRIBUTOR</td> <td>1</td> <td>PZ</td> </tr> <tr> <td>VL1081A0</td> <td>D6 BARBED NO RETURN VALVE</td> <td>1</td> <td>PZ</td> </tr> <tr> <td>VL1102A0</td> <td></td> <td>1</td> <td>PZ</td> </tr> <tr> <td>VL1102A1</td> <td>DETERGENT LINE FILTER + BARBED VNR 6 MM</td> <td>1</td> <td>PZ</td> </tr> <tr> <td>VL1128A0</td> <td>BARBED CHECK VALVE D6</td> <td>1</td> <td>PZ</td> </tr> <tr> <td>VM2172A0</td> <td>PUMP LOCKING CLIP</td> <td>1</td> <td>PZ</td> </tr> </tbody> </table>	Code	Description	Qty	UOM	GN1526A0	INT. D.=6.9 TH=1.8 O-RIN	1	PZ	RC1019A0	D=10 ELASTIC CLAMP	10	PZ	RC1242A0	D=10 CLOSED CAP	2	PZ	RC1408A0	DOUBLE WIRE SPRING CLAMP D10.8 ZN	2	PZ	TB2820A0	PIPE EPDM FOR WASHING SYSTEM	1.200	M	VI1220A1	4,2X12 TCB SELF-TAPPIN G SCREW	6	PZ	VL1019A0	VIBRATION PUMP	1	PZ	VL1053B0	ONE WASHING SYS EXT DISTRIBUTOR	1	PZ	VL1054B0	ONE WASHING SYS INLET DISTRIBUTOR	1	PZ	VL1081A0	D6 BARBED NO RETURN VALVE	1	PZ	VL1102A0		1	PZ	VL1102A1	DETERGENT LINE FILTER + BARBED VNR 6 MM	1	PZ	VL1128A0	BARBED CHECK VALVE D6	1	PZ	VM2172A0	PUMP LOCKING CLIP	1	PZ
					Code	Description	Qty	UOM																																																									
GN1526A0	INT. D.=6.9 TH=1.8 O-RIN	1	PZ																																																														
RC1019A0	D=10 ELASTIC CLAMP	10	PZ																																																														
RC1242A0	D=10 CLOSED CAP	2	PZ																																																														
RC1408A0	DOUBLE WIRE SPRING CLAMP D10.8 ZN	2	PZ																																																														
TB2820A0	PIPE EPDM FOR WASHING SYSTEM	1.200	M																																																														
VI1220A1	4,2X12 TCB SELF-TAPPIN G SCREW	6	PZ																																																														
VL1019A0	VIBRATION PUMP	1	PZ																																																														
VL1053B0	ONE WASHING SYS EXT DISTRIBUTOR	1	PZ																																																														
VL1054B0	ONE WASHING SYS INLET DISTRIBUTOR	1	PZ																																																														
VL1081A0	D6 BARBED NO RETURN VALVE	1	PZ																																																														
VL1102A0		1	PZ																																																														
VL1102A1	DETERGENT LINE FILTER + BARBED VNR 6 MM	1	PZ																																																														
VL1128A0	BARBED CHECK VALVE D6	1	PZ																																																														
VM2172A0	PUMP LOCKING CLIP	1	PZ																																																														
			KVL1109A	EUR 2 ROTOR ARMS ONE CLEANING SYSTEM KIT	<table border="1"> <thead> <tr> <th>Code</th> <th>Description</th> <th>Qty</th> <th>UOM</th> </tr> </thead> <tbody> <tr> <td>0H7324A0</td> <td>ONE OVENS WASHING SYST HOLDING PLATE</td> <td>2</td> <td>PZ</td> </tr> <tr> <td>0H7515A0</td> <td>XEVC-2011-E1 R DOUBLE WASHING SYS PLATE</td> <td>1</td> <td>PZ</td> </tr> <tr> <td>CH1000A0</td> <td>SNIP PIPE CUTTER</td> <td>1</td> <td>PZ</td> </tr> <tr> <td>EL1115A0</td> <td>Ø8 Y CONNECTION</td> <td>1</td> <td>PZ</td> </tr> </tbody> </table>	Code	Description	Qty	UOM	0H7324A0	ONE OVENS WASHING SYST HOLDING PLATE	2	PZ	0H7515A0	XEVC-2011-E1 R DOUBLE WASHING SYS PLATE	1	PZ	CH1000A0	SNIP PIPE CUTTER	1	PZ	EL1115A0	Ø8 Y CONNECTION	1	PZ																																								
Code	Description	Qty	UOM																																																														
0H7324A0	ONE OVENS WASHING SYST HOLDING PLATE	2	PZ																																																														
0H7515A0	XEVC-2011-E1 R DOUBLE WASHING SYS PLATE	1	PZ																																																														
CH1000A0	SNIP PIPE CUTTER	1	PZ																																																														
EL1115A0	Ø8 Y CONNECTION	1	PZ																																																														



COMPONENT			SPARE PART																																																																																					
Code	Description	Image	Code	Description	Components list																																																																																			
VL1019A	VIBRATION PUMP		KVL1109A	EUR 2 ROTOR ARMS ONE CLEANING SYSTEM KIT	<table border="1"> <thead> <tr> <th>Code</th> <th>Description</th> <th>Qty</th> <th>UOM</th> </tr> </thead> <tbody> <tr> <td>EL1436A0</td> <td>H2O SOLENOID JG D8 CHECK VALVE</td> <td>2</td> <td>PZ</td> </tr> <tr> <td>GN1526A0</td> <td>INT. D.=6.9 TH=1.8 O-RIN</td> <td>2</td> <td>PZ</td> </tr> <tr> <td>RC1006A0</td> <td>D8 PET PIPE GUIDE BEND</td> <td>4</td> <td>PZ</td> </tr> <tr> <td>RC1019A0</td> <td>D=10 ELASTIC CLAMP</td> <td>30</td> <td>PZ</td> </tr> <tr> <td>RC1242A0</td> <td>D=10 CLOSED CAP</td> <td>4</td> <td>PZ</td> </tr> <tr> <td>TB1818A0</td> <td>8X4.75 BLUE PE WATER INLET PIPE</td> <td>1.640</td> <td>M</td> </tr> <tr> <td>TB2820A0</td> <td>PIPE EPDM FOR WASHING SYSTEM</td> <td>2.760</td> <td>M</td> </tr> <tr> <td>VI1220A1</td> <td>4,2X12 TCB SELF-TAPPIN G SCREW</td> <td>8</td> <td>PZ</td> </tr> <tr> <td>VL1019A0</td> <td>VIBRATION PUMP</td> <td>2</td> <td>PZ</td> </tr> <tr> <td>VL1053B0</td> <td>ONE WASHING SYS EXT DISTRIBUTOR</td> <td>2</td> <td>PZ</td> </tr> <tr> <td>VL1054B0</td> <td>ONE WASHING SYS INLET DISTRIBUTOR</td> <td>2</td> <td>PZ</td> </tr> <tr> <td>VL1080A0</td> <td>DETERGENT FILTER</td> <td>2</td> <td>PZ</td> </tr> <tr> <td>VL1081A0</td> <td>D6 BARBED NO RETURN VALVE</td> <td>4</td> <td>PZ</td> </tr> <tr> <td>VL1102A0</td> <td></td> <td>2</td> <td>PZ</td> </tr> <tr> <td>VL1102A1</td> <td>DETERGENT LINE FILTER + BARBED VNR 6 MM</td> <td>2</td> <td>PZ</td> </tr> <tr> <td>VL1128A0</td> <td>BARBED CHECK VALVE D6</td> <td>2</td> <td>PZ</td> </tr> <tr> <td>VM2172A0</td> <td>PUMP LOCKING CLIP</td> <td>2</td> <td>PZ</td> </tr> </tbody> </table>	Code	Description	Qty	UOM	EL1436A0	H2O SOLENOID JG D8 CHECK VALVE	2	PZ	GN1526A0	INT. D.=6.9 TH=1.8 O-RIN	2	PZ	RC1006A0	D8 PET PIPE GUIDE BEND	4	PZ	RC1019A0	D=10 ELASTIC CLAMP	30	PZ	RC1242A0	D=10 CLOSED CAP	4	PZ	TB1818A0	8X4.75 BLUE PE WATER INLET PIPE	1.640	M	TB2820A0	PIPE EPDM FOR WASHING SYSTEM	2.760	M	VI1220A1	4,2X12 TCB SELF-TAPPIN G SCREW	8	PZ	VL1019A0	VIBRATION PUMP	2	PZ	VL1053B0	ONE WASHING SYS EXT DISTRIBUTOR	2	PZ	VL1054B0	ONE WASHING SYS INLET DISTRIBUTOR	2	PZ	VL1080A0	DETERGENT FILTER	2	PZ	VL1081A0	D6 BARBED NO RETURN VALVE	4	PZ	VL1102A0		2	PZ	VL1102A1	DETERGENT LINE FILTER + BARBED VNR 6 MM	2	PZ	VL1128A0	BARBED CHECK VALVE D6	2	PZ	VM2172A0	PUMP LOCKING CLIP	2	PZ	KVL1108A	04EU ONE EUR 1 ROTOR CLEANING SYSTEM KIT	<table border="1"> <thead> <tr> <th>Code</th> <th>Description</th> <th>Qty</th> <th>UOM</th> </tr> </thead> <tbody> <tr> <td>0H7323A0</td> <td>WASHING SYSTEM HOLDING PLATE</td> <td>1</td> <td>PZ</td> </tr> </tbody> </table>	Code	Description	Qty	UOM	0H7323A0	WASHING SYSTEM HOLDING PLATE	1	PZ
			Code	Description	Qty	UOM																																																																																		
EL1436A0	H2O SOLENOID JG D8 CHECK VALVE	2	PZ																																																																																					
GN1526A0	INT. D.=6.9 TH=1.8 O-RIN	2	PZ																																																																																					
RC1006A0	D8 PET PIPE GUIDE BEND	4	PZ																																																																																					
RC1019A0	D=10 ELASTIC CLAMP	30	PZ																																																																																					
RC1242A0	D=10 CLOSED CAP	4	PZ																																																																																					
TB1818A0	8X4.75 BLUE PE WATER INLET PIPE	1.640	M																																																																																					
TB2820A0	PIPE EPDM FOR WASHING SYSTEM	2.760	M																																																																																					
VI1220A1	4,2X12 TCB SELF-TAPPIN G SCREW	8	PZ																																																																																					
VL1019A0	VIBRATION PUMP	2	PZ																																																																																					
VL1053B0	ONE WASHING SYS EXT DISTRIBUTOR	2	PZ																																																																																					
VL1054B0	ONE WASHING SYS INLET DISTRIBUTOR	2	PZ																																																																																					
VL1080A0	DETERGENT FILTER	2	PZ																																																																																					
VL1081A0	D6 BARBED NO RETURN VALVE	4	PZ																																																																																					
VL1102A0		2	PZ																																																																																					
VL1102A1	DETERGENT LINE FILTER + BARBED VNR 6 MM	2	PZ																																																																																					
VL1128A0	BARBED CHECK VALVE D6	2	PZ																																																																																					
VM2172A0	PUMP LOCKING CLIP	2	PZ																																																																																					
Code	Description	Qty	UOM																																																																																					
0H7323A0	WASHING SYSTEM HOLDING PLATE	1	PZ																																																																																					

COMPONENT			SPARE PART																																																																														
Code	Description	Image	Code	Description	Components list																																																																												
VL1019A	VIBRATION PUMP		KVL1108A	04EU ONE EUR 1 ROTOR CLEANING SYSTEM KIT	<table border="1"> <thead> <tr> <th>Code</th> <th>Description</th> <th>Qty</th> <th>UOM</th> </tr> </thead> <tbody> <tr> <td>0H7511A0</td> <td>ONE OVENS WASHING SYST HOLDING PLATE</td> <td>1</td> <td>PZ</td> </tr> <tr> <td>EL1252A1</td> <td>1 WAY WATER VALVE + J.G. CONNECTION</td> <td>1</td> <td>PZ</td> </tr> <tr> <td>EL1424A0</td> <td>D8 CONNECTION WATER SOLENOID VALVE</td> <td>1</td> <td>PZ</td> </tr> <tr> <td>EL1436A0</td> <td>H2O SOLENOID JG D8 CHECK VALVE</td> <td>1</td> <td>PZ</td> </tr> <tr> <td>GN1526A0</td> <td>INT. D.=6.9 TH=1.8 O-RIN</td> <td>1</td> <td>PZ</td> </tr> <tr> <td>RC1006A0</td> <td>D8 PET PIPE GUIDE BEND</td> <td>2</td> <td>PZ</td> </tr> <tr> <td>RC1019A0</td> <td>D=10 ELASTIC CLAMP</td> <td>11</td> <td>PZ</td> </tr> <tr> <td>RC1130A0</td> <td>130X2,6 CLAM</td> <td>1</td> <td>PZ</td> </tr> <tr> <td>RC1242A0</td> <td>D=10 CLOSED CAP</td> <td>2</td> <td>PZ</td> </tr> <tr> <td>RC1310A0</td> <td>140X4 CLAMP WITH CLIP</td> <td>2</td> <td>PZ</td> </tr> <tr> <td>RC1356A0</td> <td>STRAIGHT THREADED FEMALE END 8X1/4" BSP</td> <td>1</td> <td>PZ</td> </tr> <tr> <td>TB1818A0</td> <td>8X4.75 BLUE PE WATER INLET PIPE</td> <td>0.220</td> <td>M</td> </tr> <tr> <td>TB2820A0</td> <td>PIPE EPDM FOR WASHING SYSTEM</td> <td>1.240</td> <td>M</td> </tr> <tr> <td>VI1220A1</td> <td>4,2X12 TCB SELF-TAPPIN G SCREW</td> <td>2</td> <td>PZ</td> </tr> <tr> <td>VL1019A0</td> <td>VIBRATION PUMP</td> <td>1</td> <td>PZ</td> </tr> <tr> <td>VL1053B0</td> <td>ONE WASHING SYS EXT DISTRIBUTOR</td> <td>1</td> <td>PZ</td> </tr> <tr> <td>VL1054B0</td> <td>ONE WASHING SYS INLET DISTRIBUTOR</td> <td>1</td> <td>PZ</td> </tr> <tr> <td>VL1064A0</td> <td>WASHING SYSTEM OUTLETS DISTRIBUTOR</td> <td>1</td> <td>PZ</td> </tr> </tbody> </table>	Code	Description	Qty	UOM	0H7511A0	ONE OVENS WASHING SYST HOLDING PLATE	1	PZ	EL1252A1	1 WAY WATER VALVE + J.G. CONNECTION	1	PZ	EL1424A0	D8 CONNECTION WATER SOLENOID VALVE	1	PZ	EL1436A0	H2O SOLENOID JG D8 CHECK VALVE	1	PZ	GN1526A0	INT. D.=6.9 TH=1.8 O-RIN	1	PZ	RC1006A0	D8 PET PIPE GUIDE BEND	2	PZ	RC1019A0	D=10 ELASTIC CLAMP	11	PZ	RC1130A0	130X2,6 CLAM	1	PZ	RC1242A0	D=10 CLOSED CAP	2	PZ	RC1310A0	140X4 CLAMP WITH CLIP	2	PZ	RC1356A0	STRAIGHT THREADED FEMALE END 8X1/4" BSP	1	PZ	TB1818A0	8X4.75 BLUE PE WATER INLET PIPE	0.220	M	TB2820A0	PIPE EPDM FOR WASHING SYSTEM	1.240	M	VI1220A1	4,2X12 TCB SELF-TAPPIN G SCREW	2	PZ	VL1019A0	VIBRATION PUMP	1	PZ	VL1053B0	ONE WASHING SYS EXT DISTRIBUTOR	1	PZ	VL1054B0	ONE WASHING SYS INLET DISTRIBUTOR	1	PZ	VL1064A0	WASHING SYSTEM OUTLETS DISTRIBUTOR	1	PZ
Code	Description	Qty	UOM																																																																														
0H7511A0	ONE OVENS WASHING SYST HOLDING PLATE	1	PZ																																																																														
EL1252A1	1 WAY WATER VALVE + J.G. CONNECTION	1	PZ																																																																														
EL1424A0	D8 CONNECTION WATER SOLENOID VALVE	1	PZ																																																																														
EL1436A0	H2O SOLENOID JG D8 CHECK VALVE	1	PZ																																																																														
GN1526A0	INT. D.=6.9 TH=1.8 O-RIN	1	PZ																																																																														
RC1006A0	D8 PET PIPE GUIDE BEND	2	PZ																																																																														
RC1019A0	D=10 ELASTIC CLAMP	11	PZ																																																																														
RC1130A0	130X2,6 CLAM	1	PZ																																																																														
RC1242A0	D=10 CLOSED CAP	2	PZ																																																																														
RC1310A0	140X4 CLAMP WITH CLIP	2	PZ																																																																														
RC1356A0	STRAIGHT THREADED FEMALE END 8X1/4" BSP	1	PZ																																																																														
TB1818A0	8X4.75 BLUE PE WATER INLET PIPE	0.220	M																																																																														
TB2820A0	PIPE EPDM FOR WASHING SYSTEM	1.240	M																																																																														
VI1220A1	4,2X12 TCB SELF-TAPPIN G SCREW	2	PZ																																																																														
VL1019A0	VIBRATION PUMP	1	PZ																																																																														
VL1053B0	ONE WASHING SYS EXT DISTRIBUTOR	1	PZ																																																																														
VL1054B0	ONE WASHING SYS INLET DISTRIBUTOR	1	PZ																																																																														
VL1064A0	WASHING SYSTEM OUTLETS DISTRIBUTOR	1	PZ																																																																														

COMPONENT			SPARE PART																																															
Code	Description	Image	Code	Description	Components list																																													
VL1019A	VIBRATION PUMP		KVL1108A	04EU ONE EUR 1 ROTOR CLEANING SYSTEM KIT	<table border="1"> <thead> <tr> <th>Code</th> <th>Description</th> <th>Qty</th> <th>UOM</th> </tr> </thead> <tbody> <tr> <td>VL1065A1</td> <td>1/4 MALE N.O. PRESSURE SWITCH</td> <td>1</td> <td>PZ</td> </tr> <tr> <td>VL1067A0</td> <td>WASHING SYSTEM INLETS DISTRIBUTOR</td> <td>1</td> <td>PZ</td> </tr> <tr> <td>VL1080A0</td> <td>DETERGENT FILTER</td> <td>1</td> <td>PZ</td> </tr> <tr> <td>VL1081A0</td> <td>D6 BARBED NO RETURN VALVE</td> <td>2</td> <td>PZ</td> </tr> <tr> <td>VL1083A0</td> <td>D=10 CONNECTION - D=6 PIPE FITTING</td> <td>1</td> <td>PZ</td> </tr> <tr> <td>VL1102A0</td> <td></td> <td>1</td> <td>PZ</td> </tr> <tr> <td>VL1128A0</td> <td>BARBED CHECK VALVE D6</td> <td>1</td> <td>PZ</td> </tr> <tr> <td>VM2172A0</td> <td>PUMP LOCKING CLIP</td> <td>1</td> <td>PZ</td> </tr> </tbody> </table>	Code	Description	Qty	UOM	VL1065A1	1/4 MALE N.O. PRESSURE SWITCH	1	PZ	VL1067A0	WASHING SYSTEM INLETS DISTRIBUTOR	1	PZ	VL1080A0	DETERGENT FILTER	1	PZ	VL1081A0	D6 BARBED NO RETURN VALVE	2	PZ	VL1083A0	D=10 CONNECTION - D=6 PIPE FITTING	1	PZ	VL1102A0		1	PZ	VL1128A0	BARBED CHECK VALVE D6	1	PZ	VM2172A0	PUMP LOCKING CLIP	1	PZ									
			Code	Description	Qty	UOM																																												
VL1065A1	1/4 MALE N.O. PRESSURE SWITCH	1	PZ																																															
VL1067A0	WASHING SYSTEM INLETS DISTRIBUTOR	1	PZ																																															
VL1080A0	DETERGENT FILTER	1	PZ																																															
VL1081A0	D6 BARBED NO RETURN VALVE	2	PZ																																															
VL1083A0	D=10 CONNECTION - D=6 PIPE FITTING	1	PZ																																															
VL1102A0		1	PZ																																															
VL1128A0	BARBED CHECK VALVE D6	1	PZ																																															
VM2172A0	PUMP LOCKING CLIP	1	PZ																																															
KVL1107A	04EU PLUS EUR 1 ROTOR CLEANING SYSTEM KIT	<table border="1"> <thead> <tr> <th>Code</th> <th>Description</th> <th>Qty</th> <th>UOM</th> </tr> </thead> <tbody> <tr> <td>0H7323A0</td> <td>WASHING SYSTEM HOLDING PLATE</td> <td>1</td> <td>PZ</td> </tr> <tr> <td>EL1252A1</td> <td>1 WAY WATER VALVE + J.G. CONNECTION</td> <td>1</td> <td>PZ</td> </tr> <tr> <td>EL1424A0</td> <td>D8 CONNECTION WATER SOLENOID VALVE</td> <td>1</td> <td>PZ</td> </tr> <tr> <td>EL1436A0</td> <td>H2O SOLENOID JG D8 CHECK VALVE</td> <td>1</td> <td>PZ</td> </tr> <tr> <td>GN1526A0</td> <td>INT. D.=6.9 TH=1.8 O-RIN</td> <td>1</td> <td>PZ</td> </tr> <tr> <td>RC1019A0</td> <td>D=10 ELASTIC CLAMP</td> <td>11</td> <td>PZ</td> </tr> <tr> <td>RC1130A0</td> <td>130X2,6 CLAM</td> <td>1</td> <td>PZ</td> </tr> <tr> <td>RC1242A0</td> <td>D=10 CLOSED CAP</td> <td>2</td> <td>PZ</td> </tr> <tr> <td>RC1310A0</td> <td>140X4 CLAMP WITH CLIP</td> <td>2</td> <td>PZ</td> </tr> <tr> <td>RC1356A0</td> <td>STRAIGHT THREADED FEMALE END 8X1/4" BSP</td> <td>1</td> <td>PZ</td> </tr> <tr> <td>TB2820A0</td> <td>PIPE EPDM FOR WASHING SYSTEM</td> <td>2.040</td> <td>M</td> </tr> </tbody> </table>	Code	Description	Qty	UOM	0H7323A0	WASHING SYSTEM HOLDING PLATE	1	PZ	EL1252A1	1 WAY WATER VALVE + J.G. CONNECTION	1	PZ	EL1424A0	D8 CONNECTION WATER SOLENOID VALVE	1	PZ	EL1436A0	H2O SOLENOID JG D8 CHECK VALVE	1	PZ	GN1526A0	INT. D.=6.9 TH=1.8 O-RIN	1	PZ	RC1019A0	D=10 ELASTIC CLAMP	11	PZ	RC1130A0	130X2,6 CLAM	1	PZ	RC1242A0	D=10 CLOSED CAP	2	PZ	RC1310A0	140X4 CLAMP WITH CLIP	2	PZ	RC1356A0	STRAIGHT THREADED FEMALE END 8X1/4" BSP	1	PZ	TB2820A0	PIPE EPDM FOR WASHING SYSTEM	2.040	M
Code	Description	Qty	UOM																																															
0H7323A0	WASHING SYSTEM HOLDING PLATE	1	PZ																																															
EL1252A1	1 WAY WATER VALVE + J.G. CONNECTION	1	PZ																																															
EL1424A0	D8 CONNECTION WATER SOLENOID VALVE	1	PZ																																															
EL1436A0	H2O SOLENOID JG D8 CHECK VALVE	1	PZ																																															
GN1526A0	INT. D.=6.9 TH=1.8 O-RIN	1	PZ																																															
RC1019A0	D=10 ELASTIC CLAMP	11	PZ																																															
RC1130A0	130X2,6 CLAM	1	PZ																																															
RC1242A0	D=10 CLOSED CAP	2	PZ																																															
RC1310A0	140X4 CLAMP WITH CLIP	2	PZ																																															
RC1356A0	STRAIGHT THREADED FEMALE END 8X1/4" BSP	1	PZ																																															
TB2820A0	PIPE EPDM FOR WASHING SYSTEM	2.040	M																																															



COMPONENT			SPARE PART																																																						
Code	Description	Image	Code	Description	Components list																																																				
VL1019A	VIBRATION PUMP		KVL1107A	04EU PLUS EUR 1 ROTOR CLEANING SYSTEM KIT	<table border="1"> <thead> <tr> <th>Code</th> <th>Description</th> <th>Qty</th> <th>UOM</th> </tr> </thead> <tbody> <tr> <td>VI1220A1</td> <td>4,2X12 TCB SELF-TAPPIN G SCREW</td> <td>2</td> <td>PZ</td> </tr> <tr> <td>VL1019A0</td> <td>VIBRATION PUMP</td> <td>1</td> <td>PZ</td> </tr> <tr> <td>VL1064A0</td> <td>WASHING SYSTEM OUTLETS DISTRIBUTOR</td> <td>1</td> <td>PZ</td> </tr> <tr> <td>VL1065A1</td> <td>1/4 MALE N.O. PRESSURE SWITCH</td> <td>1</td> <td>PZ</td> </tr> <tr> <td>VL1067A0</td> <td>WASHING SYSTEM INLETS DISTRIBUTOR</td> <td>1</td> <td>PZ</td> </tr> <tr> <td>VL1080A0</td> <td>DETERGENT FILTER</td> <td>1</td> <td>PZ</td> </tr> <tr> <td>VL1081A0</td> <td>D6 BARBED NO RETURN VALVE</td> <td>2</td> <td>PZ</td> </tr> <tr> <td>VL1083A0</td> <td>D=10 CONNECTION - D=6 PIPE FITTING</td> <td>1</td> <td>PZ</td> </tr> <tr> <td>VL1102A0</td> <td></td> <td>1</td> <td>PZ</td> </tr> <tr> <td>VL1102A1</td> <td>DETERGENT LINE FILTER + BARBED VNR 6 MM</td> <td>1</td> <td>PZ</td> </tr> <tr> <td>VL1128A0</td> <td>BARBED CHECK VALVE D6</td> <td>1</td> <td>PZ</td> </tr> <tr> <td>VM2172A0</td> <td>PUMP LOCKING CLIP</td> <td>1</td> <td>PZ</td> </tr> </tbody> </table>	Code	Description	Qty	UOM	VI1220A1	4,2X12 TCB SELF-TAPPIN G SCREW	2	PZ	VL1019A0	VIBRATION PUMP	1	PZ	VL1064A0	WASHING SYSTEM OUTLETS DISTRIBUTOR	1	PZ	VL1065A1	1/4 MALE N.O. PRESSURE SWITCH	1	PZ	VL1067A0	WASHING SYSTEM INLETS DISTRIBUTOR	1	PZ	VL1080A0	DETERGENT FILTER	1	PZ	VL1081A0	D6 BARBED NO RETURN VALVE	2	PZ	VL1083A0	D=10 CONNECTION - D=6 PIPE FITTING	1	PZ	VL1102A0		1	PZ	VL1102A1	DETERGENT LINE FILTER + BARBED VNR 6 MM	1	PZ	VL1128A0	BARBED CHECK VALVE D6	1	PZ	VM2172A0	PUMP LOCKING CLIP	1	PZ
					Code	Description	Qty	UOM																																																	
VI1220A1	4,2X12 TCB SELF-TAPPIN G SCREW	2	PZ																																																						
VL1019A0	VIBRATION PUMP	1	PZ																																																						
VL1064A0	WASHING SYSTEM OUTLETS DISTRIBUTOR	1	PZ																																																						
VL1065A1	1/4 MALE N.O. PRESSURE SWITCH	1	PZ																																																						
VL1067A0	WASHING SYSTEM INLETS DISTRIBUTOR	1	PZ																																																						
VL1080A0	DETERGENT FILTER	1	PZ																																																						
VL1081A0	D6 BARBED NO RETURN VALVE	2	PZ																																																						
VL1083A0	D=10 CONNECTION - D=6 PIPE FITTING	1	PZ																																																						
VL1102A0		1	PZ																																																						
VL1102A1	DETERGENT LINE FILTER + BARBED VNR 6 MM	1	PZ																																																						
VL1128A0	BARBED CHECK VALVE D6	1	PZ																																																						
VM2172A0	PUMP LOCKING CLIP	1	PZ																																																						
			KVL1106A	EUR 1 ROTOR ARM ONE CLEANING SYSTEM KIT	<table border="1"> <thead> <tr> <th>Code</th> <th>Description</th> <th>Qty</th> <th>UOM</th> </tr> </thead> <tbody> <tr> <td>0H7324A0</td> <td>ONE OVENS WASHING SYST HOLDING PLATE</td> <td>1</td> <td>PZ</td> </tr> <tr> <td>0H7819A0</td> <td>ONE WASHING SYS SUPPORT WITH STEAM VALVE</td> <td>1</td> <td>PZ</td> </tr> <tr> <td>EL1436A0</td> <td>H2O SOLENOID JG D8 CHECK VALVE</td> <td>1</td> <td>PZ</td> </tr> <tr> <td>GN1526A0</td> <td>INT. D.=6.9 TH=1.8 O-RIN</td> <td>1</td> <td>PZ</td> </tr> <tr> <td>RC1006A0</td> <td>D8 PET PIPE GUIDE BEND</td> <td>2</td> <td>PZ</td> </tr> </tbody> </table>	Code	Description	Qty	UOM	0H7324A0	ONE OVENS WASHING SYST HOLDING PLATE	1	PZ	0H7819A0	ONE WASHING SYS SUPPORT WITH STEAM VALVE	1	PZ	EL1436A0	H2O SOLENOID JG D8 CHECK VALVE	1	PZ	GN1526A0	INT. D.=6.9 TH=1.8 O-RIN	1	PZ	RC1006A0	D8 PET PIPE GUIDE BEND	2	PZ																												
Code	Description	Qty	UOM																																																						
0H7324A0	ONE OVENS WASHING SYST HOLDING PLATE	1	PZ																																																						
0H7819A0	ONE WASHING SYS SUPPORT WITH STEAM VALVE	1	PZ																																																						
EL1436A0	H2O SOLENOID JG D8 CHECK VALVE	1	PZ																																																						
GN1526A0	INT. D.=6.9 TH=1.8 O-RIN	1	PZ																																																						
RC1006A0	D8 PET PIPE GUIDE BEND	2	PZ																																																						



COMPONENT			SPARE PART																																																																																	
Code	Description	Image	Code	Description	Components list																																																																															
VL1019A	VIBRATION PUMP		KVL1106A	EUR 1 ROTOR ARM ONE CLEANING SYSTEM KIT	<table border="1"> <thead> <tr> <th>Code</th> <th>Description</th> <th>Qty</th> <th>UOM</th> </tr> </thead> <tbody> <tr> <td>RC1019A0</td> <td>D=10 ELASTIC CLAMP</td> <td>15</td> <td>PZ</td> </tr> <tr> <td>RC1242A0</td> <td>D=10 CLOSED CAP</td> <td>2</td> <td>PZ</td> </tr> <tr> <td>RC1408A0</td> <td>DOUBLE WIRE SPRING CLAMP D10.8 ZN</td> <td>2</td> <td>PZ</td> </tr> <tr> <td>TB1818A0</td> <td>8X4.75 BLUE PE WATER INLET PIPE</td> <td>0.320</td> <td>M</td> </tr> <tr> <td>TB2820A0</td> <td>PIPE EPDM FOR WASHING SYSTEM</td> <td>1.380</td> <td>M</td> </tr> <tr> <td>VI1220A1</td> <td>4,2X12 TCB SELF-TAPPIN G SCREW</td> <td>1</td> <td>PZ</td> </tr> <tr> <td>VL1019A0</td> <td>VIBRATION PUMP</td> <td>1</td> <td>PZ</td> </tr> <tr> <td>VL1053B0</td> <td>ONE WASHING SYS EXT DISTRIBUTOR</td> <td>1</td> <td>PZ</td> </tr> <tr> <td>VL1054B0</td> <td>ONE WASHING SYS INLET DISTRIBUTOR</td> <td>1</td> <td>PZ</td> </tr> <tr> <td>VL1080A0</td> <td>DETERGENT FILTER</td> <td>1</td> <td>PZ</td> </tr> <tr> <td>VL1081A0</td> <td>D6 BARBED NO RETURN VALVE</td> <td>1</td> <td>PZ</td> </tr> <tr> <td>VL1102A0</td> <td></td> <td>1</td> <td>PZ</td> </tr> <tr> <td>VL1102A1</td> <td>DETERGENT LINE FILTER + BARBED VNR 6 MM</td> <td>1</td> <td>PZ</td> </tr> <tr> <td>VL1128A0</td> <td>BARBED CHECK VALVE D6</td> <td>1</td> <td>PZ</td> </tr> <tr> <td>VM2172A0</td> <td>PUMP LOCKING CLIP</td> <td>1</td> <td>PZ</td> </tr> </tbody> </table>	Code	Description	Qty	UOM	RC1019A0	D=10 ELASTIC CLAMP	15	PZ	RC1242A0	D=10 CLOSED CAP	2	PZ	RC1408A0	DOUBLE WIRE SPRING CLAMP D10.8 ZN	2	PZ	TB1818A0	8X4.75 BLUE PE WATER INLET PIPE	0.320	M	TB2820A0	PIPE EPDM FOR WASHING SYSTEM	1.380	M	VI1220A1	4,2X12 TCB SELF-TAPPIN G SCREW	1	PZ	VL1019A0	VIBRATION PUMP	1	PZ	VL1053B0	ONE WASHING SYS EXT DISTRIBUTOR	1	PZ	VL1054B0	ONE WASHING SYS INLET DISTRIBUTOR	1	PZ	VL1080A0	DETERGENT FILTER	1	PZ	VL1081A0	D6 BARBED NO RETURN VALVE	1	PZ	VL1102A0		1	PZ	VL1102A1	DETERGENT LINE FILTER + BARBED VNR 6 MM	1	PZ	VL1128A0	BARBED CHECK VALVE D6	1	PZ	VM2172A0	PUMP LOCKING CLIP	1	PZ	KVL1105A	USA 2 ROTOR ARMS PLUS CLEANING SYSTEM KIT	<table border="1"> <thead> <tr> <th>Code</th> <th>Description</th> <th>Qty</th> <th>UOM</th> </tr> </thead> <tbody> <tr> <td>0H7323A0</td> <td>WASHING SYSTEM HOLDING PLATE</td> <td>1</td> <td>PZ</td> </tr> <tr> <td>0H7820A0</td> <td>PLUS WASHING SY SUPPORT WITH STEAM VALVE</td> <td>1</td> <td>PZ</td> </tr> </tbody> </table>	Code	Description	Qty	UOM	0H7323A0	WASHING SYSTEM HOLDING PLATE	1	PZ	0H7820A0	PLUS WASHING SY SUPPORT WITH STEAM VALVE	1	PZ
			Code	Description	Qty	UOM																																																																														
RC1019A0	D=10 ELASTIC CLAMP	15	PZ																																																																																	
RC1242A0	D=10 CLOSED CAP	2	PZ																																																																																	
RC1408A0	DOUBLE WIRE SPRING CLAMP D10.8 ZN	2	PZ																																																																																	
TB1818A0	8X4.75 BLUE PE WATER INLET PIPE	0.320	M																																																																																	
TB2820A0	PIPE EPDM FOR WASHING SYSTEM	1.380	M																																																																																	
VI1220A1	4,2X12 TCB SELF-TAPPIN G SCREW	1	PZ																																																																																	
VL1019A0	VIBRATION PUMP	1	PZ																																																																																	
VL1053B0	ONE WASHING SYS EXT DISTRIBUTOR	1	PZ																																																																																	
VL1054B0	ONE WASHING SYS INLET DISTRIBUTOR	1	PZ																																																																																	
VL1080A0	DETERGENT FILTER	1	PZ																																																																																	
VL1081A0	D6 BARBED NO RETURN VALVE	1	PZ																																																																																	
VL1102A0		1	PZ																																																																																	
VL1102A1	DETERGENT LINE FILTER + BARBED VNR 6 MM	1	PZ																																																																																	
VL1128A0	BARBED CHECK VALVE D6	1	PZ																																																																																	
VM2172A0	PUMP LOCKING CLIP	1	PZ																																																																																	
Code	Description	Qty	UOM																																																																																	
0H7323A0	WASHING SYSTEM HOLDING PLATE	1	PZ																																																																																	
0H7820A0	PLUS WASHING SY SUPPORT WITH STEAM VALVE	1	PZ																																																																																	



COMPONENT			SPARE PART																																																																										
Code	Description	Image	Code	Description	Components list																																																																								
VL1019A	VIBRATION PUMP		KVL1105A	USA 2ROTOR ARMS PLUS CLEANING SYSTEM KIT	<table border="1"> <thead> <tr> <th>Code</th> <th>Description</th> <th>Qty</th> <th>UOM</th> </tr> </thead> <tbody> <tr> <td>EL1020A1</td> <td>D8 INTERMEDIAT E T-SHAPED FITTING</td> <td>1</td> <td>PZ</td> </tr> <tr> <td>EL1422A0</td> <td>1 WAY SOLENOID VALVE + D8-D10 REDUCTION</td> <td>1</td> <td>PZ</td> </tr> <tr> <td>EL1422A1</td> <td>1 WAY SOLENOID VALVE + D8-D10 REDUCTION</td> <td>1</td> <td>PZ</td> </tr> <tr> <td>EL1426A0</td> <td>H2O UL SOLENOID JG D8-PIPE HOLDER</td> <td>2</td> <td>PZ</td> </tr> <tr> <td>EL1437A0</td> <td>H2O SOLENOID JG D6 UL CHECK VALVE</td> <td>1</td> <td>PZ</td> </tr> <tr> <td>GN1526A0</td> <td>INT. D.=6.9 TH=1.8 O-RIN</td> <td>1</td> <td>PZ</td> </tr> <tr> <td>RC1019A0</td> <td>D=10 ELASTIC CLAMP</td> <td>12</td> <td>PZ</td> </tr> <tr> <td>RC1130A0</td> <td>130X2,6 CLAM</td> <td>1</td> <td>PZ</td> </tr> <tr> <td>RC1242A0</td> <td>D=10 CLOSED CAP</td> <td>2</td> <td>PZ</td> </tr> <tr> <td>RC1310A0</td> <td>140X4 CLAMP WITH CLIP</td> <td>2</td> <td>PZ</td> </tr> <tr> <td>RC1356A0</td> <td>STRAIGHT THREADED FEMALE END 8X1/4" BSP</td> <td>1</td> <td>PZ</td> </tr> <tr> <td>RC1408A0</td> <td>DOUBLE WIRE SPRING CLAMP D10.8 ZN</td> <td>2</td> <td>PZ</td> </tr> <tr> <td>TB1818A0</td> <td>8X4.75 BLUE PE WATER INLET PIPE</td> <td>0.300</td> <td>M</td> </tr> <tr> <td>TB2820A0</td> <td>PIPE EPDM FOR WASHING SYSTEM</td> <td>2.040</td> <td>M</td> </tr> <tr> <td>VI1220A1</td> <td>4,2X12 TCB SELF-TAPPIN G SCREW</td> <td>2</td> <td>PZ</td> </tr> <tr> <td>VL1019A0</td> <td>VIBRATION PUMP</td> <td>1</td> <td>PZ</td> </tr> <tr> <td>VL1065A1</td> <td>1/4 MALE N.O. PRESSURE SWITCH</td> <td>1</td> <td>PZ</td> </tr> </tbody> </table>	Code	Description	Qty	UOM	EL1020A1	D8 INTERMEDIAT E T-SHAPED FITTING	1	PZ	EL1422A0	1 WAY SOLENOID VALVE + D8-D10 REDUCTION	1	PZ	EL1422A1	1 WAY SOLENOID VALVE + D8-D10 REDUCTION	1	PZ	EL1426A0	H2O UL SOLENOID JG D8-PIPE HOLDER	2	PZ	EL1437A0	H2O SOLENOID JG D6 UL CHECK VALVE	1	PZ	GN1526A0	INT. D.=6.9 TH=1.8 O-RIN	1	PZ	RC1019A0	D=10 ELASTIC CLAMP	12	PZ	RC1130A0	130X2,6 CLAM	1	PZ	RC1242A0	D=10 CLOSED CAP	2	PZ	RC1310A0	140X4 CLAMP WITH CLIP	2	PZ	RC1356A0	STRAIGHT THREADED FEMALE END 8X1/4" BSP	1	PZ	RC1408A0	DOUBLE WIRE SPRING CLAMP D10.8 ZN	2	PZ	TB1818A0	8X4.75 BLUE PE WATER INLET PIPE	0.300	M	TB2820A0	PIPE EPDM FOR WASHING SYSTEM	2.040	M	VI1220A1	4,2X12 TCB SELF-TAPPIN G SCREW	2	PZ	VL1019A0	VIBRATION PUMP	1	PZ	VL1065A1	1/4 MALE N.O. PRESSURE SWITCH	1	PZ
Code	Description	Qty	UOM																																																																										
EL1020A1	D8 INTERMEDIAT E T-SHAPED FITTING	1	PZ																																																																										
EL1422A0	1 WAY SOLENOID VALVE + D8-D10 REDUCTION	1	PZ																																																																										
EL1422A1	1 WAY SOLENOID VALVE + D8-D10 REDUCTION	1	PZ																																																																										
EL1426A0	H2O UL SOLENOID JG D8-PIPE HOLDER	2	PZ																																																																										
EL1437A0	H2O SOLENOID JG D6 UL CHECK VALVE	1	PZ																																																																										
GN1526A0	INT. D.=6.9 TH=1.8 O-RIN	1	PZ																																																																										
RC1019A0	D=10 ELASTIC CLAMP	12	PZ																																																																										
RC1130A0	130X2,6 CLAM	1	PZ																																																																										
RC1242A0	D=10 CLOSED CAP	2	PZ																																																																										
RC1310A0	140X4 CLAMP WITH CLIP	2	PZ																																																																										
RC1356A0	STRAIGHT THREADED FEMALE END 8X1/4" BSP	1	PZ																																																																										
RC1408A0	DOUBLE WIRE SPRING CLAMP D10.8 ZN	2	PZ																																																																										
TB1818A0	8X4.75 BLUE PE WATER INLET PIPE	0.300	M																																																																										
TB2820A0	PIPE EPDM FOR WASHING SYSTEM	2.040	M																																																																										
VI1220A1	4,2X12 TCB SELF-TAPPIN G SCREW	2	PZ																																																																										
VL1019A0	VIBRATION PUMP	1	PZ																																																																										
VL1065A1	1/4 MALE N.O. PRESSURE SWITCH	1	PZ																																																																										





COMPONENT			SPARE PART																																										
Code	Description	Image	Code	Description	Components list																																								
VL1019A	VIBRATION PUMP		KVL1105A	USA 2 ROTOR ARMS PLUS CLEANING SYSTEM KIT	<table border="1"> <thead> <tr> <th>Code</th> <th>Description</th> <th>Qty</th> <th>UOM</th> </tr> </thead> <tbody> <tr> <td>VL1067A0</td> <td>WASHING SYSTEM INLETS DISTRIBUTOR</td> <td>1</td> <td>PZ</td> </tr> <tr> <td>VL1080A0</td> <td>DETERGENT FILTER</td> <td>1</td> <td>PZ</td> </tr> <tr> <td>VL1081A0</td> <td>D6 BARBED NO RETURN VALVE</td> <td>2</td> <td>PZ</td> </tr> <tr> <td>VL1083A0</td> <td>D=10 CONNECTION - D=6 PIPE FITTING</td> <td>1</td> <td>PZ</td> </tr> <tr> <td>VL1092A0</td> <td>WASHING SYSTEM OUTLET DOUBLE DISTRIBUTOR</td> <td>1</td> <td>PZ</td> </tr> <tr> <td>VL1102A0</td> <td></td> <td>1</td> <td>PZ</td> </tr> <tr> <td>VL1102A1</td> <td>DETERGENT LINE FILTER + BARBED VNR 6 MM</td> <td>1</td> <td>PZ</td> </tr> <tr> <td>VL1128A0</td> <td>BARBED CHECK VALVE D6</td> <td>1</td> <td>PZ</td> </tr> <tr> <td>VM2172A0</td> <td>PUMP LOCKING CLIP</td> <td>1</td> <td>PZ</td> </tr> </tbody> </table>	Code	Description	Qty	UOM	VL1067A0	WASHING SYSTEM INLETS DISTRIBUTOR	1	PZ	VL1080A0	DETERGENT FILTER	1	PZ	VL1081A0	D6 BARBED NO RETURN VALVE	2	PZ	VL1083A0	D=10 CONNECTION - D=6 PIPE FITTING	1	PZ	VL1092A0	WASHING SYSTEM OUTLET DOUBLE DISTRIBUTOR	1	PZ	VL1102A0		1	PZ	VL1102A1	DETERGENT LINE FILTER + BARBED VNR 6 MM	1	PZ	VL1128A0	BARBED CHECK VALVE D6	1	PZ	VM2172A0	PUMP LOCKING CLIP	1	PZ
			Code	Description	Qty	UOM																																							
VL1067A0	WASHING SYSTEM INLETS DISTRIBUTOR	1	PZ																																										
VL1080A0	DETERGENT FILTER	1	PZ																																										
VL1081A0	D6 BARBED NO RETURN VALVE	2	PZ																																										
VL1083A0	D=10 CONNECTION - D=6 PIPE FITTING	1	PZ																																										
VL1092A0	WASHING SYSTEM OUTLET DOUBLE DISTRIBUTOR	1	PZ																																										
VL1102A0		1	PZ																																										
VL1102A1	DETERGENT LINE FILTER + BARBED VNR 6 MM	1	PZ																																										
VL1128A0	BARBED CHECK VALVE D6	1	PZ																																										
VM2172A0	PUMP LOCKING CLIP	1	PZ																																										
KVL1104A	USA 1 ROTOR ARM PLUS CLEANING SYSTEM KIT	<table border="1"> <thead> <tr> <th>Code</th> <th>Description</th> <th>Qty</th> <th>UOM</th> </tr> </thead> <tbody> <tr> <td>0H7323A0</td> <td>WASHING SYSTEM HOLDING PLATE</td> <td>1</td> <td>PZ</td> </tr> <tr> <td>0H7820A0</td> <td>PLUS WASHING SY SUPPORT WITH STEAM VALVE</td> <td>1</td> <td>PZ</td> </tr> <tr> <td>EL1020A1</td> <td>D8 INTERMEDIAT E T-SHAPED FITTING</td> <td>1</td> <td>PZ</td> </tr> <tr> <td>EL1422A0</td> <td>1 WAY SOLENOID VALVE + D8-D10 REDUCTION</td> <td>1</td> <td>PZ</td> </tr> <tr> <td>EL1422A1</td> <td>1 WAY SOLENOID VALVE + D8-D10 REDUCTION</td> <td>1</td> <td>PZ</td> </tr> </tbody> </table>	Code	Description	Qty	UOM	0H7323A0	WASHING SYSTEM HOLDING PLATE	1	PZ	0H7820A0	PLUS WASHING SY SUPPORT WITH STEAM VALVE	1	PZ	EL1020A1	D8 INTERMEDIAT E T-SHAPED FITTING	1	PZ	EL1422A0	1 WAY SOLENOID VALVE + D8-D10 REDUCTION	1	PZ	EL1422A1	1 WAY SOLENOID VALVE + D8-D10 REDUCTION	1	PZ																			
Code	Description	Qty	UOM																																										
0H7323A0	WASHING SYSTEM HOLDING PLATE	1	PZ																																										
0H7820A0	PLUS WASHING SY SUPPORT WITH STEAM VALVE	1	PZ																																										
EL1020A1	D8 INTERMEDIAT E T-SHAPED FITTING	1	PZ																																										
EL1422A0	1 WAY SOLENOID VALVE + D8-D10 REDUCTION	1	PZ																																										
EL1422A1	1 WAY SOLENOID VALVE + D8-D10 REDUCTION	1	PZ																																										



COMPONENT			SPARE PART																																																																														
Code	Description	Image	Code	Description	Components list																																																																												
VL1019A	VIBRATION PUMP		KVL1104A	USA 1 ROTOR ARM PLUS CLEANING SYSTEM KIT	<table border="1"> <thead> <tr> <th>Code</th> <th>Description</th> <th>Qty</th> <th>UOM</th> </tr> </thead> <tbody> <tr> <td>EL1426A0</td> <td>H2O UL SOLENOID JG D8-PIPE HOLDER</td> <td>1</td> <td>PZ</td> </tr> <tr> <td>EL1437A0</td> <td>H2O SOLENOID JG D6 UL CHECK VALVE</td> <td>1</td> <td>PZ</td> </tr> <tr> <td>GN1526A0</td> <td>INT. D.=6.9 TH=1.8 O-RIN</td> <td>1</td> <td>PZ</td> </tr> <tr> <td>RC1019A0</td> <td>D=10 ELASTIC CLAMP</td> <td>11</td> <td>PZ</td> </tr> <tr> <td>RC1130A0</td> <td>130X2,6 CLAM</td> <td>1</td> <td>PZ</td> </tr> <tr> <td>RC1242A0</td> <td>D=10 CLOSED CAP</td> <td>2</td> <td>PZ</td> </tr> <tr> <td>RC1310A0</td> <td>140X4 CLAMP WITH CLIP</td> <td>2</td> <td>PZ</td> </tr> <tr> <td>RC1356A0</td> <td>STRAIGHT THREADED FEMALE END 8X1/4" BSP</td> <td>1</td> <td>PZ</td> </tr> <tr> <td>RC1408A0</td> <td>DOUBLE WIRE SPRING CLAMP D10.8 ZN</td> <td>2</td> <td>PZ</td> </tr> <tr> <td>TB1818A0</td> <td>8X4.75 BLUE PE WATER INLET PIPE</td> <td>0.300</td> <td>M</td> </tr> <tr> <td>TB2820A0</td> <td>PIPE EPDM FOR WASHING SYSTEM</td> <td>1.240</td> <td>M</td> </tr> <tr> <td>VH1220A1</td> <td>4,2X12 TCB SELF-TAPPIN G SCREW</td> <td>2</td> <td>PZ</td> </tr> <tr> <td>VL1019A0</td> <td>VIBRATION PUMP</td> <td>1</td> <td>PZ</td> </tr> <tr> <td>VL1064A0</td> <td>WASHING SYSTEM OUTLETS DISTRIBUTOR</td> <td>1</td> <td>PZ</td> </tr> <tr> <td>VL1065A1</td> <td>1/4 MALE N.O. PRESSURE SWITCH</td> <td>1</td> <td>PZ</td> </tr> <tr> <td>VL1067A0</td> <td>WASHING SYSTEM INLETS DISTRIBUTOR</td> <td>1</td> <td>PZ</td> </tr> <tr> <td>VL1080A0</td> <td>DETERGENT FILTER</td> <td>1</td> <td>PZ</td> </tr> <tr> <td>VL1081A0</td> <td>D6 BARBED NO RETURN VALVE</td> <td>2</td> <td>PZ</td> </tr> </tbody> </table>	Code	Description	Qty	UOM	EL1426A0	H2O UL SOLENOID JG D8-PIPE HOLDER	1	PZ	EL1437A0	H2O SOLENOID JG D6 UL CHECK VALVE	1	PZ	GN1526A0	INT. D.=6.9 TH=1.8 O-RIN	1	PZ	RC1019A0	D=10 ELASTIC CLAMP	11	PZ	RC1130A0	130X2,6 CLAM	1	PZ	RC1242A0	D=10 CLOSED CAP	2	PZ	RC1310A0	140X4 CLAMP WITH CLIP	2	PZ	RC1356A0	STRAIGHT THREADED FEMALE END 8X1/4" BSP	1	PZ	RC1408A0	DOUBLE WIRE SPRING CLAMP D10.8 ZN	2	PZ	TB1818A0	8X4.75 BLUE PE WATER INLET PIPE	0.300	M	TB2820A0	PIPE EPDM FOR WASHING SYSTEM	1.240	M	VH1220A1	4,2X12 TCB SELF-TAPPIN G SCREW	2	PZ	VL1019A0	VIBRATION PUMP	1	PZ	VL1064A0	WASHING SYSTEM OUTLETS DISTRIBUTOR	1	PZ	VL1065A1	1/4 MALE N.O. PRESSURE SWITCH	1	PZ	VL1067A0	WASHING SYSTEM INLETS DISTRIBUTOR	1	PZ	VL1080A0	DETERGENT FILTER	1	PZ	VL1081A0	D6 BARBED NO RETURN VALVE	2	PZ
Code	Description	Qty	UOM																																																																														
EL1426A0	H2O UL SOLENOID JG D8-PIPE HOLDER	1	PZ																																																																														
EL1437A0	H2O SOLENOID JG D6 UL CHECK VALVE	1	PZ																																																																														
GN1526A0	INT. D.=6.9 TH=1.8 O-RIN	1	PZ																																																																														
RC1019A0	D=10 ELASTIC CLAMP	11	PZ																																																																														
RC1130A0	130X2,6 CLAM	1	PZ																																																																														
RC1242A0	D=10 CLOSED CAP	2	PZ																																																																														
RC1310A0	140X4 CLAMP WITH CLIP	2	PZ																																																																														
RC1356A0	STRAIGHT THREADED FEMALE END 8X1/4" BSP	1	PZ																																																																														
RC1408A0	DOUBLE WIRE SPRING CLAMP D10.8 ZN	2	PZ																																																																														
TB1818A0	8X4.75 BLUE PE WATER INLET PIPE	0.300	M																																																																														
TB2820A0	PIPE EPDM FOR WASHING SYSTEM	1.240	M																																																																														
VH1220A1	4,2X12 TCB SELF-TAPPIN G SCREW	2	PZ																																																																														
VL1019A0	VIBRATION PUMP	1	PZ																																																																														
VL1064A0	WASHING SYSTEM OUTLETS DISTRIBUTOR	1	PZ																																																																														
VL1065A1	1/4 MALE N.O. PRESSURE SWITCH	1	PZ																																																																														
VL1067A0	WASHING SYSTEM INLETS DISTRIBUTOR	1	PZ																																																																														
VL1080A0	DETERGENT FILTER	1	PZ																																																																														
VL1081A0	D6 BARBED NO RETURN VALVE	2	PZ																																																																														





COMPONENT			SPARE PART																																																			
Code	Description	Image	Code	Description	Components list																																																	
VL1019A	VIBRATION PUMP		KVL1104A	USA 1 ROTOR ARM PLUS CLEANING SYSTEM KIT	<table border="1"> <thead> <tr> <th>Code</th> <th>Description</th> <th>Qty</th> <th>UOM</th> </tr> </thead> <tbody> <tr> <td>VL1083A0</td> <td>D=10 CONNECTION - D=6 PIPE FITTING</td> <td>1</td> <td>PZ</td> </tr> <tr> <td>VL1102A0</td> <td></td> <td>1</td> <td>PZ</td> </tr> <tr> <td>VL1102A1</td> <td>DETERGENT LINE FILTER + BARBED VNR 6 MM</td> <td>1</td> <td>PZ</td> </tr> <tr> <td>VL1128A0</td> <td>BARBED CHECK VALVE D6</td> <td>1</td> <td>PZ</td> </tr> <tr> <td>VM2172A0</td> <td>PUMP LOCKING CLIP</td> <td>1</td> <td>PZ</td> </tr> </tbody> </table>	Code	Description	Qty	UOM	VL1083A0	D=10 CONNECTION - D=6 PIPE FITTING	1	PZ	VL1102A0		1	PZ	VL1102A1	DETERGENT LINE FILTER + BARBED VNR 6 MM	1	PZ	VL1128A0	BARBED CHECK VALVE D6	1	PZ	VM2172A0	PUMP LOCKING CLIP	1	PZ																									
			Code	Description	Qty	UOM																																																
VL1083A0	D=10 CONNECTION - D=6 PIPE FITTING	1	PZ																																																			
VL1102A0		1	PZ																																																			
VL1102A1	DETERGENT LINE FILTER + BARBED VNR 6 MM	1	PZ																																																			
VL1128A0	BARBED CHECK VALVE D6	1	PZ																																																			
VM2172A0	PUMP LOCKING CLIP	1	PZ																																																			
KVL1103A	EUR 2 ROTOR ARMS PLUS CLEANING SYSTEM KIT	<table border="1"> <thead> <tr> <th>Code</th> <th>Description</th> <th>Qty</th> <th>UOM</th> </tr> </thead> <tbody> <tr> <td>0H7323A0</td> <td>WASHING SYSTEM HOLDING PLATE</td> <td>1</td> <td>PZ</td> </tr> <tr> <td>0H7820A0</td> <td>PLUS WASHING SY SUPPORT WITH STEAM VALVE</td> <td>1</td> <td>PZ</td> </tr> <tr> <td>EL1252A1</td> <td>1 WAY WATER VALVE + J.G. CONNECTION</td> <td>1</td> <td>PZ</td> </tr> <tr> <td>EL1424A0</td> <td>D8 CONNECTION WATER SOLENOID VALVE</td> <td>2</td> <td>PZ</td> </tr> <tr> <td>EL1436A0</td> <td>H2O SOLENOID JG D8 CHECK VALVE</td> <td>1</td> <td>PZ</td> </tr> <tr> <td>GN1526A0</td> <td>INT. D.=6.9 TH=1.8 O-RIN</td> <td>1</td> <td>PZ</td> </tr> <tr> <td>RC1019A0</td> <td>D=10 ELASTIC CLAMP</td> <td>12</td> <td>PZ</td> </tr> <tr> <td>RC1130A0</td> <td>130X2,6 CLAM</td> <td>1</td> <td>PZ</td> </tr> <tr> <td>RC1242A0</td> <td>D=10 CLOSED CAP</td> <td>2</td> <td>PZ</td> </tr> <tr> <td>RC1310A0</td> <td>140X4 CLAMP WITH CLIP</td> <td>2</td> <td>PZ</td> </tr> <tr> <td>RC1356A0</td> <td>STRAIGHT THREADED FEMALE END 8X1/4" BSP</td> <td>1</td> <td>PZ</td> </tr> <tr> <td>RC1408A0</td> <td>DOUBLE WIRE SPRING CLAMP D10.8 ZN</td> <td>2</td> <td>PZ</td> </tr> </tbody> </table>	Code	Description	Qty	UOM	0H7323A0	WASHING SYSTEM HOLDING PLATE	1	PZ	0H7820A0	PLUS WASHING SY SUPPORT WITH STEAM VALVE	1	PZ	EL1252A1	1 WAY WATER VALVE + J.G. CONNECTION	1	PZ	EL1424A0	D8 CONNECTION WATER SOLENOID VALVE	2	PZ	EL1436A0	H2O SOLENOID JG D8 CHECK VALVE	1	PZ	GN1526A0	INT. D.=6.9 TH=1.8 O-RIN	1	PZ	RC1019A0	D=10 ELASTIC CLAMP	12	PZ	RC1130A0	130X2,6 CLAM	1	PZ	RC1242A0	D=10 CLOSED CAP	2	PZ	RC1310A0	140X4 CLAMP WITH CLIP	2	PZ	RC1356A0	STRAIGHT THREADED FEMALE END 8X1/4" BSP	1	PZ	RC1408A0	DOUBLE WIRE SPRING CLAMP D10.8 ZN	2	PZ
Code	Description	Qty	UOM																																																			
0H7323A0	WASHING SYSTEM HOLDING PLATE	1	PZ																																																			
0H7820A0	PLUS WASHING SY SUPPORT WITH STEAM VALVE	1	PZ																																																			
EL1252A1	1 WAY WATER VALVE + J.G. CONNECTION	1	PZ																																																			
EL1424A0	D8 CONNECTION WATER SOLENOID VALVE	2	PZ																																																			
EL1436A0	H2O SOLENOID JG D8 CHECK VALVE	1	PZ																																																			
GN1526A0	INT. D.=6.9 TH=1.8 O-RIN	1	PZ																																																			
RC1019A0	D=10 ELASTIC CLAMP	12	PZ																																																			
RC1130A0	130X2,6 CLAM	1	PZ																																																			
RC1242A0	D=10 CLOSED CAP	2	PZ																																																			
RC1310A0	140X4 CLAMP WITH CLIP	2	PZ																																																			
RC1356A0	STRAIGHT THREADED FEMALE END 8X1/4" BSP	1	PZ																																																			
RC1408A0	DOUBLE WIRE SPRING CLAMP D10.8 ZN	2	PZ																																																			

COMPONENT			SPARE PART																																																																													
Code	Description	Image	Code	Description	Components list																																																																											
VL1019A	VIBRATION PUMP		KVL1103A	EUR 2 ROTOR ARMS PLUS CLEANING SYSTEM KIT	<table border="1"> <thead> <tr> <th>Code</th> <th>Description</th> <th>Qty</th> <th>UOM</th> </tr> </thead> <tbody> <tr> <td>TB1818A0</td> <td>8X4.75 BLUE PE WATER INLET PIPE</td> <td>0.220</td> <td>M</td> </tr> <tr> <td>TB2820A0</td> <td>PIPE EPDM FOR WASHING SYSTEM</td> <td>2.040</td> <td>M</td> </tr> <tr> <td>VI1220A1</td> <td>4,2X12 TCB SELF-TAPPING SCREW</td> <td>2</td> <td>PZ</td> </tr> <tr> <td>VL1019A0</td> <td>VIBRATION PUMP</td> <td>1</td> <td>PZ</td> </tr> <tr> <td>VL1065A1</td> <td>1/4 MALE N.O. PRESSURE SWITCH</td> <td>1</td> <td>PZ</td> </tr> <tr> <td>VL1067A0</td> <td>WASHING SYSTEM INLETS DISTRIBUTOR</td> <td>1</td> <td>PZ</td> </tr> <tr> <td>VL1080A0</td> <td>DETERGENT FILTER</td> <td>1</td> <td>PZ</td> </tr> <tr> <td>VL1081A0</td> <td>D6 BARBED NO RETURN VALVE</td> <td>2</td> <td>PZ</td> </tr> <tr> <td>VL1083A0</td> <td>D=10 CONNECTION - D=6 PIPE FITTING</td> <td>1</td> <td>PZ</td> </tr> <tr> <td>VL1092A0</td> <td>WASHING SYSTEM OUTLET DOUBLE DISTRIBUTOR</td> <td>1</td> <td>PZ</td> </tr> <tr> <td>VL1102A0</td> <td></td> <td>1</td> <td>PZ</td> </tr> <tr> <td>VL1102A1</td> <td>DETERGENT LINE FILTER + BARBED VNR 6 MM</td> <td>1</td> <td>PZ</td> </tr> <tr> <td>VL1128A0</td> <td>BARBED CHECK VALVE D6</td> <td>1</td> <td>PZ</td> </tr> <tr> <td>VM2172A0</td> <td>PUMP LOCKING CLIP</td> <td>1</td> <td>PZ</td> </tr> </tbody> </table>	Code	Description	Qty	UOM	TB1818A0	8X4.75 BLUE PE WATER INLET PIPE	0.220	M	TB2820A0	PIPE EPDM FOR WASHING SYSTEM	2.040	M	VI1220A1	4,2X12 TCB SELF-TAPPING SCREW	2	PZ	VL1019A0	VIBRATION PUMP	1	PZ	VL1065A1	1/4 MALE N.O. PRESSURE SWITCH	1	PZ	VL1067A0	WASHING SYSTEM INLETS DISTRIBUTOR	1	PZ	VL1080A0	DETERGENT FILTER	1	PZ	VL1081A0	D6 BARBED NO RETURN VALVE	2	PZ	VL1083A0	D=10 CONNECTION - D=6 PIPE FITTING	1	PZ	VL1092A0	WASHING SYSTEM OUTLET DOUBLE DISTRIBUTOR	1	PZ	VL1102A0		1	PZ	VL1102A1	DETERGENT LINE FILTER + BARBED VNR 6 MM	1	PZ	VL1128A0	BARBED CHECK VALVE D6	1	PZ	VM2172A0	PUMP LOCKING CLIP	1	PZ	KVL1101A	EUR 1 ROTOR ARM PLUS CLEANING SYSTEM KIT	<table border="1"> <thead> <tr> <th>Code</th> <th>Description</th> <th>Qty</th> <th>UOM</th> </tr> </thead> <tbody> <tr> <td>0H7323A0</td> <td>WASHING SYSTEM HOLDING PLATE</td> <td>1</td> <td>PZ</td> </tr> <tr> <td>0H7820A0</td> <td>PLUS WASHING SY SUPPORT WITH STEAM VALVE</td> <td>1</td> <td>PZ</td> </tr> </tbody> </table>	Code	Description	Qty	UOM	0H7323A0	WASHING SYSTEM HOLDING PLATE	1	PZ	0H7820A0	PLUS WASHING SY SUPPORT WITH STEAM VALVE	1	PZ
			Code	Description	Qty	UOM																																																																										
TB1818A0	8X4.75 BLUE PE WATER INLET PIPE	0.220	M																																																																													
TB2820A0	PIPE EPDM FOR WASHING SYSTEM	2.040	M																																																																													
VI1220A1	4,2X12 TCB SELF-TAPPING SCREW	2	PZ																																																																													
VL1019A0	VIBRATION PUMP	1	PZ																																																																													
VL1065A1	1/4 MALE N.O. PRESSURE SWITCH	1	PZ																																																																													
VL1067A0	WASHING SYSTEM INLETS DISTRIBUTOR	1	PZ																																																																													
VL1080A0	DETERGENT FILTER	1	PZ																																																																													
VL1081A0	D6 BARBED NO RETURN VALVE	2	PZ																																																																													
VL1083A0	D=10 CONNECTION - D=6 PIPE FITTING	1	PZ																																																																													
VL1092A0	WASHING SYSTEM OUTLET DOUBLE DISTRIBUTOR	1	PZ																																																																													
VL1102A0		1	PZ																																																																													
VL1102A1	DETERGENT LINE FILTER + BARBED VNR 6 MM	1	PZ																																																																													
VL1128A0	BARBED CHECK VALVE D6	1	PZ																																																																													
VM2172A0	PUMP LOCKING CLIP	1	PZ																																																																													
Code	Description	Qty	UOM																																																																													
0H7323A0	WASHING SYSTEM HOLDING PLATE	1	PZ																																																																													
0H7820A0	PLUS WASHING SY SUPPORT WITH STEAM VALVE	1	PZ																																																																													



COMPONENT			SPARE PART																																																																														
Code	Description	Image	Code	Description	Components list																																																																												
VL1019A	VIBRATION PUMP		KVL1101A	EUR 1 ROTOR ARM PLUS CLEANING SYSTEM KIT	<table border="1"> <thead> <tr> <th>Code</th> <th>Description</th> <th>Qty</th> <th>UOM</th> </tr> </thead> <tbody> <tr> <td>EL1252A1</td> <td>1 WAY WATER VALVE + J.G. CONNECTION</td> <td>1</td> <td>PZ</td> </tr> <tr> <td>EL1424A0</td> <td>D8 CONNECTION WATER SOLENOID VALVE</td> <td>1</td> <td>PZ</td> </tr> <tr> <td>EL1436A0</td> <td>H2O SOLENOID JG D8 CHECK VALVE</td> <td>1</td> <td>PZ</td> </tr> <tr> <td>GN1526A0</td> <td>INT. D.=6.9 TH=1.8 O-RIN</td> <td>1</td> <td>PZ</td> </tr> <tr> <td>RC1019A0</td> <td>D=10 ELASTIC CLAMP</td> <td>11</td> <td>PZ</td> </tr> <tr> <td>RC1130A0</td> <td>130X2,6 CLAM</td> <td>1</td> <td>PZ</td> </tr> <tr> <td>RC1242A0</td> <td>D=10 CLOSED CAP</td> <td>2</td> <td>PZ</td> </tr> <tr> <td>RC1310A0</td> <td>140X4 CLAMP WITH CLIP</td> <td>2</td> <td>PZ</td> </tr> <tr> <td>RC1356A0</td> <td>STRAIGHT THREADED FEMALE END 8X1/4" BSP</td> <td>1</td> <td>PZ</td> </tr> <tr> <td>RC1408A0</td> <td>DOUBLE WIRE SPRING CLAMP D10.8 ZN</td> <td>6</td> <td>PZ</td> </tr> <tr> <td>TB1818A0</td> <td>8X4.75 BLUE PE WATER INLET PIPE</td> <td>0.220</td> <td>M</td> </tr> <tr> <td>TB2820A0</td> <td>PIPE EPDM FOR WASHING SYSTEM</td> <td>1.240</td> <td>M</td> </tr> <tr> <td>VI1220A1</td> <td>4,2X12 TCB SELF-TAPPIN G SCREW</td> <td>2</td> <td>PZ</td> </tr> <tr> <td>VL1019A0</td> <td>VIBRATION PUMP</td> <td>1</td> <td>PZ</td> </tr> <tr> <td>VL1064A0</td> <td>WASHING SYSTEM OUTLETS DISTRIBUTOR</td> <td>1</td> <td>PZ</td> </tr> <tr> <td>VL1065A1</td> <td>1/4 MALE N.O. PRESSURE SWITCH</td> <td>1</td> <td>PZ</td> </tr> <tr> <td>VL1067A0</td> <td>WASHING SYSTEM INLETS DISTRIBUTOR</td> <td>1</td> <td>PZ</td> </tr> <tr> <td>VL1080A0</td> <td>DETERGENT FILTER</td> <td>1</td> <td>PZ</td> </tr> </tbody> </table>	Code	Description	Qty	UOM	EL1252A1	1 WAY WATER VALVE + J.G. CONNECTION	1	PZ	EL1424A0	D8 CONNECTION WATER SOLENOID VALVE	1	PZ	EL1436A0	H2O SOLENOID JG D8 CHECK VALVE	1	PZ	GN1526A0	INT. D.=6.9 TH=1.8 O-RIN	1	PZ	RC1019A0	D=10 ELASTIC CLAMP	11	PZ	RC1130A0	130X2,6 CLAM	1	PZ	RC1242A0	D=10 CLOSED CAP	2	PZ	RC1310A0	140X4 CLAMP WITH CLIP	2	PZ	RC1356A0	STRAIGHT THREADED FEMALE END 8X1/4" BSP	1	PZ	RC1408A0	DOUBLE WIRE SPRING CLAMP D10.8 ZN	6	PZ	TB1818A0	8X4.75 BLUE PE WATER INLET PIPE	0.220	M	TB2820A0	PIPE EPDM FOR WASHING SYSTEM	1.240	M	VI1220A1	4,2X12 TCB SELF-TAPPIN G SCREW	2	PZ	VL1019A0	VIBRATION PUMP	1	PZ	VL1064A0	WASHING SYSTEM OUTLETS DISTRIBUTOR	1	PZ	VL1065A1	1/4 MALE N.O. PRESSURE SWITCH	1	PZ	VL1067A0	WASHING SYSTEM INLETS DISTRIBUTOR	1	PZ	VL1080A0	DETERGENT FILTER	1	PZ
Code	Description	Qty	UOM																																																																														
EL1252A1	1 WAY WATER VALVE + J.G. CONNECTION	1	PZ																																																																														
EL1424A0	D8 CONNECTION WATER SOLENOID VALVE	1	PZ																																																																														
EL1436A0	H2O SOLENOID JG D8 CHECK VALVE	1	PZ																																																																														
GN1526A0	INT. D.=6.9 TH=1.8 O-RIN	1	PZ																																																																														
RC1019A0	D=10 ELASTIC CLAMP	11	PZ																																																																														
RC1130A0	130X2,6 CLAM	1	PZ																																																																														
RC1242A0	D=10 CLOSED CAP	2	PZ																																																																														
RC1310A0	140X4 CLAMP WITH CLIP	2	PZ																																																																														
RC1356A0	STRAIGHT THREADED FEMALE END 8X1/4" BSP	1	PZ																																																																														
RC1408A0	DOUBLE WIRE SPRING CLAMP D10.8 ZN	6	PZ																																																																														
TB1818A0	8X4.75 BLUE PE WATER INLET PIPE	0.220	M																																																																														
TB2820A0	PIPE EPDM FOR WASHING SYSTEM	1.240	M																																																																														
VI1220A1	4,2X12 TCB SELF-TAPPIN G SCREW	2	PZ																																																																														
VL1019A0	VIBRATION PUMP	1	PZ																																																																														
VL1064A0	WASHING SYSTEM OUTLETS DISTRIBUTOR	1	PZ																																																																														
VL1065A1	1/4 MALE N.O. PRESSURE SWITCH	1	PZ																																																																														
VL1067A0	WASHING SYSTEM INLETS DISTRIBUTOR	1	PZ																																																																														
VL1080A0	DETERGENT FILTER	1	PZ																																																																														



COMPONENT			SPARE PART																																																						
Code	Description	Image	Code	Description	Components list																																																				
VL1019A	VIBRATION PUMP		KVL1101A	EUR 1 ROTOR ARM PLUS CLEANING SYSTEM KIT	<table border="1"> <thead> <tr> <th>Code</th> <th>Description</th> <th>Qty</th> <th>UOM</th> </tr> </thead> <tbody> <tr> <td>VL1081A0</td> <td>D6 BARBED NO RETURN VALVE</td> <td>2</td> <td>PZ</td> </tr> <tr> <td>VL1083A0</td> <td>D=10 CONNECTION - D=6 PIPE FITTING</td> <td>1</td> <td>PZ</td> </tr> <tr> <td>VL1102A0</td> <td></td> <td>1</td> <td>PZ</td> </tr> <tr> <td>VL1102A1</td> <td>DETERGENT LINE FILTER + BARBED VNR 6 MM</td> <td>1</td> <td>PZ</td> </tr> <tr> <td>VL1128A0</td> <td>BARBED CHECK VALVE D6</td> <td>1</td> <td>PZ</td> </tr> <tr> <td>VM2172A0</td> <td>PUMP LOCKING CLIP</td> <td>1</td> <td>PZ</td> </tr> </tbody> </table>	Code	Description	Qty	UOM	VL1081A0	D6 BARBED NO RETURN VALVE	2	PZ	VL1083A0	D=10 CONNECTION - D=6 PIPE FITTING	1	PZ	VL1102A0		1	PZ	VL1102A1	DETERGENT LINE FILTER + BARBED VNR 6 MM	1	PZ	VL1128A0	BARBED CHECK VALVE D6	1	PZ	VM2172A0	PUMP LOCKING CLIP	1	PZ																								
Code	Description	Qty	UOM																																																						
VL1081A0	D6 BARBED NO RETURN VALVE	2	PZ																																																						
VL1083A0	D=10 CONNECTION - D=6 PIPE FITTING	1	PZ																																																						
VL1102A0		1	PZ																																																						
VL1102A1	DETERGENT LINE FILTER + BARBED VNR 6 MM	1	PZ																																																						
VL1128A0	BARBED CHECK VALVE D6	1	PZ																																																						
VM2172A0	PUMP LOCKING CLIP	1	PZ																																																						
			KVL1094A	0311 EUR CLEANING SYSTEM KIT	<table border="1"> <thead> <tr> <th>Code</th> <th>Description</th> <th>Qty</th> <th>UOM</th> </tr> </thead> <tbody> <tr> <td>0H7494A0</td> <td>ONE-03 WASHING SYST HOLDING PLATE</td> <td>1</td> <td>PZ</td> </tr> <tr> <td>0H7494B0</td> <td>ONE-03 WASHING SYST HOLDING PLATE</td> <td>1</td> <td>PZ</td> </tr> <tr> <td>EL1436A0</td> <td>H2O SOLENOID JG D8 CHECK VALVE</td> <td>1</td> <td>PZ</td> </tr> <tr> <td>GN1526A0</td> <td>INT. D.=6.9 TH=1.8 O-RING</td> <td>1</td> <td>PZ</td> </tr> <tr> <td>RC1006A0</td> <td>D8 PET PIPE GUIDE BEND</td> <td>2</td> <td>PZ</td> </tr> <tr> <td>RC1019A0</td> <td>D=10 ELASTIC CLAMP</td> <td>15</td> <td>PZ</td> </tr> <tr> <td>RC1242A0</td> <td>D=10 CLOSED CAP</td> <td>2</td> <td>PZ</td> </tr> <tr> <td>RC1408A0</td> <td>DOUBLE WIRE SPRING CLAMP D10.8 ZN</td> <td>4</td> <td>PZ</td> </tr> <tr> <td>TB1818A0</td> <td>8X4.75 BLUE PE WATER INLET PIPE</td> <td>0.320</td> <td>M</td> </tr> <tr> <td>TB2820A0</td> <td>PIPE EPDM FOR WASHING SYSTEM</td> <td>1.030</td> <td>M</td> </tr> <tr> <td>VI1220A1</td> <td>4,2X12 TCB SELF-TAPPIN G SCREW</td> <td>1</td> <td>PZ</td> </tr> <tr> <td>VL1019A0</td> <td>VIBRATION PUMP</td> <td>1</td> <td>PZ</td> </tr> </tbody> </table>	Code	Description	Qty	UOM	0H7494A0	ONE-03 WASHING SYST HOLDING PLATE	1	PZ	0H7494B0	ONE-03 WASHING SYST HOLDING PLATE	1	PZ	EL1436A0	H2O SOLENOID JG D8 CHECK VALVE	1	PZ	GN1526A0	INT. D.=6.9 TH=1.8 O-RING	1	PZ	RC1006A0	D8 PET PIPE GUIDE BEND	2	PZ	RC1019A0	D=10 ELASTIC CLAMP	15	PZ	RC1242A0	D=10 CLOSED CAP	2	PZ	RC1408A0	DOUBLE WIRE SPRING CLAMP D10.8 ZN	4	PZ	TB1818A0	8X4.75 BLUE PE WATER INLET PIPE	0.320	M	TB2820A0	PIPE EPDM FOR WASHING SYSTEM	1.030	M	VI1220A1	4,2X12 TCB SELF-TAPPIN G SCREW	1	PZ	VL1019A0	VIBRATION PUMP	1	PZ
Code	Description	Qty	UOM																																																						
0H7494A0	ONE-03 WASHING SYST HOLDING PLATE	1	PZ																																																						
0H7494B0	ONE-03 WASHING SYST HOLDING PLATE	1	PZ																																																						
EL1436A0	H2O SOLENOID JG D8 CHECK VALVE	1	PZ																																																						
GN1526A0	INT. D.=6.9 TH=1.8 O-RING	1	PZ																																																						
RC1006A0	D8 PET PIPE GUIDE BEND	2	PZ																																																						
RC1019A0	D=10 ELASTIC CLAMP	15	PZ																																																						
RC1242A0	D=10 CLOSED CAP	2	PZ																																																						
RC1408A0	DOUBLE WIRE SPRING CLAMP D10.8 ZN	4	PZ																																																						
TB1818A0	8X4.75 BLUE PE WATER INLET PIPE	0.320	M																																																						
TB2820A0	PIPE EPDM FOR WASHING SYSTEM	1.030	M																																																						
VI1220A1	4,2X12 TCB SELF-TAPPIN G SCREW	1	PZ																																																						
VL1019A0	VIBRATION PUMP	1	PZ																																																						

COMPONENT			SPARE PART																																																		
Code	Description	Image	Code	Description	Components list																																																
VL1019A	VIBRATION PUMP		KVL1094A	0311 EUR CLEANING SYSTEM KIT	<table border="1"> <thead> <tr> <th>Code</th> <th>Description</th> <th>Qty</th> <th>UOM</th> </tr> </thead> <tbody> <tr> <td>VL1053B0</td> <td>ONE WASHING SYS EXT DISTRIBUTOR</td> <td>1</td> <td>PZ</td> </tr> <tr> <td>VL1054B0</td> <td>ONE WASHING SYS INLET DISTRIBUTOR</td> <td>1</td> <td>PZ</td> </tr> <tr> <td>VL1080A0</td> <td>DETERGENT FILTER</td> <td>1</td> <td>PZ</td> </tr> <tr> <td>VL1081A0</td> <td>D6 BARBED NO RETURN VALVE</td> <td>1</td> <td>PZ</td> </tr> <tr> <td>VL1102A0</td> <td></td> <td>1</td> <td>PZ</td> </tr> <tr> <td>VL1102A1</td> <td>DETERGENT LINE FILTER + BARBED VNR 6 MM</td> <td>1</td> <td>PZ</td> </tr> <tr> <td>VL1128A0</td> <td>BARBED CHECK VALVE D6</td> <td>1</td> <td>PZ</td> </tr> <tr> <td>VM2172A0</td> <td>PUMP LOCKING CLIP</td> <td>1</td> <td>PZ</td> </tr> </tbody> </table>	Code	Description	Qty	UOM	VL1053B0	ONE WASHING SYS EXT DISTRIBUTOR	1	PZ	VL1054B0	ONE WASHING SYS INLET DISTRIBUTOR	1	PZ	VL1080A0	DETERGENT FILTER	1	PZ	VL1081A0	D6 BARBED NO RETURN VALVE	1	PZ	VL1102A0		1	PZ	VL1102A1	DETERGENT LINE FILTER + BARBED VNR 6 MM	1	PZ	VL1128A0	BARBED CHECK VALVE D6	1	PZ	VM2172A0	PUMP LOCKING CLIP	1	PZ												
Code	Description	Qty	UOM																																																		
VL1053B0	ONE WASHING SYS EXT DISTRIBUTOR	1	PZ																																																		
VL1054B0	ONE WASHING SYS INLET DISTRIBUTOR	1	PZ																																																		
VL1080A0	DETERGENT FILTER	1	PZ																																																		
VL1081A0	D6 BARBED NO RETURN VALVE	1	PZ																																																		
VL1102A0		1	PZ																																																		
VL1102A1	DETERGENT LINE FILTER + BARBED VNR 6 MM	1	PZ																																																		
VL1128A0	BARBED CHECK VALVE D6	1	PZ																																																		
VM2172A0	PUMP LOCKING CLIP	1	PZ																																																		
			KVL1092A	EUR 2 ROTOR ARMS PLUS CHEMICAL PUMP KIT	<table border="1"> <thead> <tr> <th>Code</th> <th>Description</th> <th>Qty</th> <th>UOM</th> </tr> </thead> <tbody> <tr> <td>GN1526A0</td> <td>INT. D.=6.9 TH=1.8 O-RIN</td> <td>1</td> <td>PZ</td> </tr> <tr> <td>RC1019A0</td> <td>D=10 ELASTIC CLAMP</td> <td>4</td> <td>PZ</td> </tr> <tr> <td>RC1130A0</td> <td>130X2,6 CLAM</td> <td>1</td> <td>PZ</td> </tr> <tr> <td>RC1242A0</td> <td>D=10 CLOSED CAP</td> <td>2</td> <td>PZ</td> </tr> <tr> <td>RC1408A0</td> <td>DOUBLE WIRE SPRING CLAMP D10.8 ZN</td> <td>4</td> <td>PZ</td> </tr> <tr> <td>TB2820A0</td> <td>PIPE EPDM FOR WASHING SYSTEM</td> <td>0.120</td> <td>M</td> </tr> <tr> <td>V11220A1</td> <td>4,2X12 TCB SELF-TAPPIN G SCREW</td> <td>2</td> <td>PZ</td> </tr> <tr> <td>VL1019A0</td> <td>VIBRATION PUMP</td> <td>1</td> <td>PZ</td> </tr> <tr> <td>VL1067A0</td> <td>WASHING SYSTEM INLETS DISTRIBUTOR</td> <td>1</td> <td>PZ</td> </tr> <tr> <td>VL1081A0</td> <td>D6 BARBED NO RETURN VALVE</td> <td>1</td> <td>PZ</td> </tr> <tr> <td>VL1092A0</td> <td>WASHING SYSTEM OUTLET DOUBLE DISTRIBUTOR</td> <td>1</td> <td>PZ</td> </tr> </tbody> </table>	Code	Description	Qty	UOM	GN1526A0	INT. D.=6.9 TH=1.8 O-RIN	1	PZ	RC1019A0	D=10 ELASTIC CLAMP	4	PZ	RC1130A0	130X2,6 CLAM	1	PZ	RC1242A0	D=10 CLOSED CAP	2	PZ	RC1408A0	DOUBLE WIRE SPRING CLAMP D10.8 ZN	4	PZ	TB2820A0	PIPE EPDM FOR WASHING SYSTEM	0.120	M	V11220A1	4,2X12 TCB SELF-TAPPIN G SCREW	2	PZ	VL1019A0	VIBRATION PUMP	1	PZ	VL1067A0	WASHING SYSTEM INLETS DISTRIBUTOR	1	PZ	VL1081A0	D6 BARBED NO RETURN VALVE	1	PZ	VL1092A0	WASHING SYSTEM OUTLET DOUBLE DISTRIBUTOR	1	PZ
Code	Description	Qty	UOM																																																		
GN1526A0	INT. D.=6.9 TH=1.8 O-RIN	1	PZ																																																		
RC1019A0	D=10 ELASTIC CLAMP	4	PZ																																																		
RC1130A0	130X2,6 CLAM	1	PZ																																																		
RC1242A0	D=10 CLOSED CAP	2	PZ																																																		
RC1408A0	DOUBLE WIRE SPRING CLAMP D10.8 ZN	4	PZ																																																		
TB2820A0	PIPE EPDM FOR WASHING SYSTEM	0.120	M																																																		
V11220A1	4,2X12 TCB SELF-TAPPIN G SCREW	2	PZ																																																		
VL1019A0	VIBRATION PUMP	1	PZ																																																		
VL1067A0	WASHING SYSTEM INLETS DISTRIBUTOR	1	PZ																																																		
VL1081A0	D6 BARBED NO RETURN VALVE	1	PZ																																																		
VL1092A0	WASHING SYSTEM OUTLET DOUBLE DISTRIBUTOR	1	PZ																																																		

COMPONENT			SPARE PART																																																			
Code	Description	Image	Code	Description	Components list																																																	
VL1019A	VIBRATION PUMP		KVL1092A	EUR 2 ROTOR ARMS PLUS CHEMICAL PUMP KIT	<table border="1"> <thead> <tr> <th>Code</th> <th>Description</th> <th>Qty</th> <th>UOM</th> </tr> </thead> <tbody> <tr> <td>VL1128A0</td> <td>BARBED CHECK VALVE D6</td> <td>1</td> <td>PZ</td> </tr> <tr> <td>VM2172A0</td> <td>PUMP LOCKING CLIP</td> <td>1</td> <td>PZ</td> </tr> </tbody> </table>	Code	Description	Qty	UOM	VL1128A0	BARBED CHECK VALVE D6	1	PZ	VM2172A0	PUMP LOCKING CLIP	1	PZ																																					
			Code	Description	Qty	UOM																																																
			VL1128A0	BARBED CHECK VALVE D6	1	PZ																																																
VM2172A0	PUMP LOCKING CLIP	1	PZ																																																			
KVL1073A	EUR 1 ROTOR ARM PLUS CHEMICAL PUMP KIT	<table border="1"> <thead> <tr> <th>Code</th> <th>Description</th> <th>Qty</th> <th>UOM</th> </tr> </thead> <tbody> <tr> <td>GN1526A0</td> <td>INT. D.=6.9 TH=1.8 O-RIN</td> <td>1</td> <td>PZ</td> </tr> <tr> <td>RC1019A0</td> <td>D=10 ELASTIC CLAMP</td> <td>4</td> <td>PZ</td> </tr> <tr> <td>RC1130A0</td> <td>130X2,6 CLAM</td> <td>1</td> <td>PZ</td> </tr> <tr> <td>RC1242A0</td> <td>D=10 CLOSED CAP</td> <td>2</td> <td>PZ</td> </tr> <tr> <td>RC1408A0</td> <td>DOUBLE WIRE SPRING CLAMP D10.8 ZN</td> <td>2</td> <td>PZ</td> </tr> <tr> <td>TB2820A0</td> <td>PIPE EPDM FOR WASHING SYSTEM</td> <td>0.120</td> <td>M</td> </tr> <tr> <td>VL1019A0</td> <td>VIBRATION PUMP</td> <td>1</td> <td>PZ</td> </tr> <tr> <td>VL1064A0</td> <td>WASHING SYSTEM OUTLETS DISTRIBUTOR</td> <td>1</td> <td>PZ</td> </tr> <tr> <td>VL1067A0</td> <td>WASHING SYSTEM INLETS DISTRIBUTOR</td> <td>1</td> <td>PZ</td> </tr> <tr> <td>VL1081A0</td> <td>D6 BARBED NO RETURN VALVE</td> <td>1</td> <td>PZ</td> </tr> <tr> <td>VL1128A0</td> <td>BARBED CHECK VALVE D6</td> <td>1</td> <td>PZ</td> </tr> <tr> <td>VM2172A0</td> <td>PUMP LOCKING CLIP</td> <td>1</td> <td>PZ</td> </tr> </tbody> </table>	Code	Description	Qty	UOM	GN1526A0	INT. D.=6.9 TH=1.8 O-RIN	1	PZ	RC1019A0	D=10 ELASTIC CLAMP	4	PZ	RC1130A0	130X2,6 CLAM	1	PZ	RC1242A0	D=10 CLOSED CAP	2	PZ	RC1408A0	DOUBLE WIRE SPRING CLAMP D10.8 ZN	2	PZ	TB2820A0	PIPE EPDM FOR WASHING SYSTEM	0.120	M	VL1019A0	VIBRATION PUMP	1	PZ	VL1064A0	WASHING SYSTEM OUTLETS DISTRIBUTOR	1	PZ	VL1067A0	WASHING SYSTEM INLETS DISTRIBUTOR	1	PZ	VL1081A0	D6 BARBED NO RETURN VALVE	1	PZ	VL1128A0	BARBED CHECK VALVE D6	1	PZ	VM2172A0	PUMP LOCKING CLIP	1	PZ
Code	Description	Qty	UOM																																																			
GN1526A0	INT. D.=6.9 TH=1.8 O-RIN	1	PZ																																																			
RC1019A0	D=10 ELASTIC CLAMP	4	PZ																																																			
RC1130A0	130X2,6 CLAM	1	PZ																																																			
RC1242A0	D=10 CLOSED CAP	2	PZ																																																			
RC1408A0	DOUBLE WIRE SPRING CLAMP D10.8 ZN	2	PZ																																																			
TB2820A0	PIPE EPDM FOR WASHING SYSTEM	0.120	M																																																			
VL1019A0	VIBRATION PUMP	1	PZ																																																			
VL1064A0	WASHING SYSTEM OUTLETS DISTRIBUTOR	1	PZ																																																			
VL1067A0	WASHING SYSTEM INLETS DISTRIBUTOR	1	PZ																																																			
VL1081A0	D6 BARBED NO RETURN VALVE	1	PZ																																																			
VL1128A0	BARBED CHECK VALVE D6	1	PZ																																																			
VM2172A0	PUMP LOCKING CLIP	1	PZ																																																			
KVL1072A	ONE SERIES CHEMICAL PUMP KI	<table border="1"> <thead> <tr> <th>Code</th> <th>Description</th> <th>Qty</th> <th>UOM</th> </tr> </thead> <tbody> <tr> <td>GN1526A0</td> <td>INT. D.=6.9 TH=1.8 O-RIN</td> <td>1</td> <td>PZ</td> </tr> <tr> <td>RC1019A0</td> <td>D=10 ELASTIC CLAMP</td> <td>3</td> <td>PZ</td> </tr> <tr> <td>RC1242A0</td> <td>D=10 CLOSED CAP</td> <td>2</td> <td>PZ</td> </tr> <tr> <td>RC1408A0</td> <td>DOUBLE WIRE SPRING CLAMP D10.8 ZN</td> <td>2</td> <td>PZ</td> </tr> <tr> <td>TB2820A0</td> <td>PIPE EPDM FOR WASHING SYSTEM</td> <td>0.120</td> <td>M</td> </tr> </tbody> </table>	Code	Description	Qty	UOM	GN1526A0	INT. D.=6.9 TH=1.8 O-RIN	1	PZ	RC1019A0	D=10 ELASTIC CLAMP	3	PZ	RC1242A0	D=10 CLOSED CAP	2	PZ	RC1408A0	DOUBLE WIRE SPRING CLAMP D10.8 ZN	2	PZ	TB2820A0	PIPE EPDM FOR WASHING SYSTEM	0.120	M																												
Code	Description	Qty	UOM																																																			
GN1526A0	INT. D.=6.9 TH=1.8 O-RIN	1	PZ																																																			
RC1019A0	D=10 ELASTIC CLAMP	3	PZ																																																			
RC1242A0	D=10 CLOSED CAP	2	PZ																																																			
RC1408A0	DOUBLE WIRE SPRING CLAMP D10.8 ZN	2	PZ																																																			
TB2820A0	PIPE EPDM FOR WASHING SYSTEM	0.120	M																																																			

COMPONENT			SPARE PART																																																		
Code	Description	Image	Code	Description	Components list																																																
VL1019A	VIBRATION PUMP		KVL1072A	ONE SERIES CHEMICAL PUMP KI	<table border="1"> <thead> <tr> <th>Code</th> <th>Description</th> <th>Qty</th> <th>UOM</th> </tr> </thead> <tbody> <tr> <td>VI1220A1</td> <td>4,2X12 TCB SELF-TAPPIN G SCREW</td> <td>1</td> <td>PZ</td> </tr> <tr> <td>VL1019A0</td> <td>VIBRATION PUMP</td> <td>1</td> <td>PZ</td> </tr> <tr> <td>VL1053B0</td> <td>ONE WASHING SYS EXT DISTRIBUTOR</td> <td>1</td> <td>PZ</td> </tr> <tr> <td>VL1054B0</td> <td>ONE WASHING SYS INLET DISTRIBUTOR</td> <td>1</td> <td>PZ</td> </tr> <tr> <td>VL1081A0</td> <td>D6 BARBED NO RETURN VALVE</td> <td>2</td> <td>PZ</td> </tr> <tr> <td>VL1128A0</td> <td>BARBED CHECK VALVE D6</td> <td>1</td> <td>PZ</td> </tr> <tr> <td>VM2172A0</td> <td>PUMP LOCKING CLIP</td> <td>1</td> <td>PZ</td> </tr> </tbody> </table>	Code	Description	Qty	UOM	VI1220A1	4,2X12 TCB SELF-TAPPIN G SCREW	1	PZ	VL1019A0	VIBRATION PUMP	1	PZ	VL1053B0	ONE WASHING SYS EXT DISTRIBUTOR	1	PZ	VL1054B0	ONE WASHING SYS INLET DISTRIBUTOR	1	PZ	VL1081A0	D6 BARBED NO RETURN VALVE	2	PZ	VL1128A0	BARBED CHECK VALVE D6	1	PZ	VM2172A0	PUMP LOCKING CLIP	1	PZ																
Code	Description	Qty	UOM																																																		
VI1220A1	4,2X12 TCB SELF-TAPPIN G SCREW	1	PZ																																																		
VL1019A0	VIBRATION PUMP	1	PZ																																																		
VL1053B0	ONE WASHING SYS EXT DISTRIBUTOR	1	PZ																																																		
VL1054B0	ONE WASHING SYS INLET DISTRIBUTOR	1	PZ																																																		
VL1081A0	D6 BARBED NO RETURN VALVE	2	PZ																																																		
VL1128A0	BARBED CHECK VALVE D6	1	PZ																																																		
VM2172A0	PUMP LOCKING CLIP	1	PZ																																																		
			KVL0001A	LM TOP CLEANING SYSTEM KIT	<table border="1"> <thead> <tr> <th>Code</th> <th>Description</th> <th>Qty</th> <th>UOM</th> </tr> </thead> <tbody> <tr> <td>0H1226A0</td> <td>LINEMISSTOP WASHING SYTEM CIRCUIT COVE</td> <td>1</td> <td>PZ</td> </tr> <tr> <td>0H1226B0</td> <td>LINEMISSTOP WASHING SYTEM CIRCUIT COVE</td> <td>1</td> <td>PZ</td> </tr> <tr> <td>EL1180A0</td> <td>Ø8-Ø8 FEMALE NON-RETURN CONNECTION</td> <td>1</td> <td>PZ</td> </tr> <tr> <td>GN1312A0</td> <td>RUBBER CABLE-PASSI NG DE=26 DI=15 SP=10</td> <td>1</td> <td>PZ</td> </tr> <tr> <td>GN1526A0</td> <td>INT. D.=6.9 TH=1.8 O-RIN</td> <td>1</td> <td>PZ</td> </tr> <tr> <td>RC1008A0</td> <td>D9 ELASTIC CLIP</td> <td>3</td> <td>PZ</td> </tr> <tr> <td>RC1019A0</td> <td>D=10 ELASTIC CLAMP</td> <td>3</td> <td>PZ</td> </tr> <tr> <td>RC1242A0</td> <td>D=10 CLOSED CAP</td> <td>2</td> <td>PZ</td> </tr> <tr> <td>RC1381A0</td> <td>BIFILAR PIPE CLIP D10,7</td> <td>3</td> <td>PZ</td> </tr> <tr> <td>RC1408A0</td> <td>DOUBLE WIRE SPRING CLAMP D10.8 ZN</td> <td>2</td> <td>PZ</td> </tr> <tr> <td>TB2343A0</td> <td>9X6 PVC TRANSPAREN T PIPE</td> <td>2.630</td> <td>M</td> </tr> </tbody> </table>	Code	Description	Qty	UOM	0H1226A0	LINEMISSTOP WASHING SYTEM CIRCUIT COVE	1	PZ	0H1226B0	LINEMISSTOP WASHING SYTEM CIRCUIT COVE	1	PZ	EL1180A0	Ø8-Ø8 FEMALE NON-RETURN CONNECTION	1	PZ	GN1312A0	RUBBER CABLE-PASSI NG DE=26 DI=15 SP=10	1	PZ	GN1526A0	INT. D.=6.9 TH=1.8 O-RIN	1	PZ	RC1008A0	D9 ELASTIC CLIP	3	PZ	RC1019A0	D=10 ELASTIC CLAMP	3	PZ	RC1242A0	D=10 CLOSED CAP	2	PZ	RC1381A0	BIFILAR PIPE CLIP D10,7	3	PZ	RC1408A0	DOUBLE WIRE SPRING CLAMP D10.8 ZN	2	PZ	TB2343A0	9X6 PVC TRANSPAREN T PIPE	2.630	M
Code	Description	Qty	UOM																																																		
0H1226A0	LINEMISSTOP WASHING SYTEM CIRCUIT COVE	1	PZ																																																		
0H1226B0	LINEMISSTOP WASHING SYTEM CIRCUIT COVE	1	PZ																																																		
EL1180A0	Ø8-Ø8 FEMALE NON-RETURN CONNECTION	1	PZ																																																		
GN1312A0	RUBBER CABLE-PASSI NG DE=26 DI=15 SP=10	1	PZ																																																		
GN1526A0	INT. D.=6.9 TH=1.8 O-RIN	1	PZ																																																		
RC1008A0	D9 ELASTIC CLIP	3	PZ																																																		
RC1019A0	D=10 ELASTIC CLAMP	3	PZ																																																		
RC1242A0	D=10 CLOSED CAP	2	PZ																																																		
RC1381A0	BIFILAR PIPE CLIP D10,7	3	PZ																																																		
RC1408A0	DOUBLE WIRE SPRING CLAMP D10.8 ZN	2	PZ																																																		
TB2343A0	9X6 PVC TRANSPAREN T PIPE	2.630	M																																																		











COMPONENT			SPARE PART																																																																						
Code	Description	Image	Code	Description	Components list																																																																				
VL1019A	VIBRATION PUMP		KVL0001A	LM TOP CLEANING SYSTEM KIT	<table border="1"> <thead> <tr> <th>Code</th> <th>Description</th> <th>Qty</th> <th>UOM</th> </tr> </thead> <tbody> <tr> <td>TB2820A0</td> <td>PIPE EPDM FOR WASHING SYSTEM</td> <td>0.990</td> <td>M</td> </tr> <tr> <td>VI1220A1</td> <td>4,2X12 TCB SELF-TAPPING SCREW</td> <td>1</td> <td>PZ</td> </tr> <tr> <td>VL1019A0</td> <td>VIBRATION PUMP</td> <td>1</td> <td>PZ</td> </tr> <tr> <td>VL1041C0</td> <td>DETERGENT CAP WITH Ø12 HOLE</td> <td>1</td> <td>PZ</td> </tr> <tr> <td>VL1047A1</td> <td>D6 PIPE HOLDER - D8 J.G. TERMINAL</td> <td>1</td> <td>PZ</td> </tr> <tr> <td>VL1053A1</td> <td></td> <td>1</td> <td>PZ</td> </tr> <tr> <td>VL1053B0</td> <td>ONE WASHING SYS EXT DISTRIBUTOR</td> <td>1</td> <td>PZ</td> </tr> <tr> <td>VL1054A1</td> <td></td> <td>1</td> <td>PZ</td> </tr> <tr> <td>VL1054B0</td> <td>ONE WASHING SYS INLET DISTRIBUTOR</td> <td>1</td> <td>PZ</td> </tr> <tr> <td>VL1061A0</td> <td>HOLD DOWN WEIGHT+NET FILTER+NON-RET. V.</td> <td>1</td> <td>PZ</td> </tr> <tr> <td>VL1081A0</td> <td>D6 BARBED NO RETURN VALVE</td> <td>1</td> <td>PZ</td> </tr> <tr> <td>VL1128A0</td> <td>BARBED CHECK VALVE D6</td> <td>2</td> <td>PZ</td> </tr> <tr> <td>VM1066A0</td> <td>SADDLE CLIP FOR CABLES PASSING</td> <td>3</td> <td>PZ</td> </tr> <tr> <td>VM1088A0</td> <td>NYLON CLICK CLAMP D7.9-D9.2</td> <td>1</td> <td>PZ</td> </tr> <tr> <td>VM1605A0</td> <td>CLIP TWIST LOCK DIAM. 10.2-12.7 MM</td> <td>1</td> <td>PZ</td> </tr> <tr> <td>VM2172A0</td> <td>PUMP LOCKING CLIP</td> <td>1</td> <td>PZ</td> </tr> </tbody> </table>	Code	Description	Qty	UOM	TB2820A0	PIPE EPDM FOR WASHING SYSTEM	0.990	M	VI1220A1	4,2X12 TCB SELF-TAPPING SCREW	1	PZ	VL1019A0	VIBRATION PUMP	1	PZ	VL1041C0	DETERGENT CAP WITH Ø12 HOLE	1	PZ	VL1047A1	D6 PIPE HOLDER - D8 J.G. TERMINAL	1	PZ	VL1053A1		1	PZ	VL1053B0	ONE WASHING SYS EXT DISTRIBUTOR	1	PZ	VL1054A1		1	PZ	VL1054B0	ONE WASHING SYS INLET DISTRIBUTOR	1	PZ	VL1061A0	HOLD DOWN WEIGHT+NET FILTER+NON-RET. V.	1	PZ	VL1081A0	D6 BARBED NO RETURN VALVE	1	PZ	VL1128A0	BARBED CHECK VALVE D6	2	PZ	VM1066A0	SADDLE CLIP FOR CABLES PASSING	3	PZ	VM1088A0	NYLON CLICK CLAMP D7.9-D9.2	1	PZ	VM1605A0	CLIP TWIST LOCK DIAM. 10.2-12.7 MM	1	PZ	VM2172A0	PUMP LOCKING CLIP	1	PZ
Code	Description	Qty	UOM																																																																						
TB2820A0	PIPE EPDM FOR WASHING SYSTEM	0.990	M																																																																						
VI1220A1	4,2X12 TCB SELF-TAPPING SCREW	1	PZ																																																																						
VL1019A0	VIBRATION PUMP	1	PZ																																																																						
VL1041C0	DETERGENT CAP WITH Ø12 HOLE	1	PZ																																																																						
VL1047A1	D6 PIPE HOLDER - D8 J.G. TERMINAL	1	PZ																																																																						
VL1053A1		1	PZ																																																																						
VL1053B0	ONE WASHING SYS EXT DISTRIBUTOR	1	PZ																																																																						
VL1054A1		1	PZ																																																																						
VL1054B0	ONE WASHING SYS INLET DISTRIBUTOR	1	PZ																																																																						
VL1061A0	HOLD DOWN WEIGHT+NET FILTER+NON-RET. V.	1	PZ																																																																						
VL1081A0	D6 BARBED NO RETURN VALVE	1	PZ																																																																						
VL1128A0	BARBED CHECK VALVE D6	2	PZ																																																																						
VM1066A0	SADDLE CLIP FOR CABLES PASSING	3	PZ																																																																						
VM1088A0	NYLON CLICK CLAMP D7.9-D9.2	1	PZ																																																																						
VM1605A0	CLIP TWIST LOCK DIAM. 10.2-12.7 MM	1	PZ																																																																						
VM2172A0	PUMP LOCKING CLIP	1	PZ																																																																						



PLATON SERVICE  
8 (800) 500-34-47  
www.platonservice.com







COMPONENT			SPARE PART																		
Code	Description	Image	Code	Description	Components list																
VM2172A	PUMP LOCKING CLI		VM2172A0	PUMP LOCKING CLI																	
RC1019A	D=10 ELASTIC CLAM		KRC1019A	Ø10 ZINC PLATED ELASTIC CLAMP 15 PCS KIT	<table border="1"> <thead> <tr> <th>Code</th> <th>Description</th> <th>Qty</th> <th>UOM</th> </tr> </thead> <tbody> <tr> <td>RC1019A0</td> <td>D=10 ELASTIC CLAMP</td> <td>15</td> <td>PZ</td> </tr> </tbody> </table>	Code	Description	Qty	UOM	RC1019A0	D=10 ELASTIC CLAMP	15	PZ								
Code	Description	Qty	UOM																		
RC1019A0	D=10 ELASTIC CLAMP	15	PZ																		
RC1356A	STRAIGHT THREADED FEMALE END 8X1/4" BSP		KRC1356A	STRAIGHT THREADED FEMALE END 8X1/4 BS	<table border="1"> <thead> <tr> <th>Code</th> <th>Description</th> <th>Qty</th> <th>UOM</th> </tr> </thead> <tbody> <tr> <td>RC1356A0</td> <td>STRAIGHT THREADED FEMALE END 8X1/4" BSP</td> <td>1</td> <td>PZ</td> </tr> </tbody> </table>	Code	Description	Qty	UOM	RC1356A0	STRAIGHT THREADED FEMALE END 8X1/4" BSP	1	PZ								
Code	Description	Qty	UOM																		
RC1356A0	STRAIGHT THREADED FEMALE END 8X1/4" BSP	1	PZ																		
VL1065A	1/4 MALE N.O. PRESSURE SWITCH		KVL1065A	1/4 M N.O. CIL. PRESSURE SWITCH KIT	<table border="1"> <thead> <tr> <th>Code</th> <th>Description</th> <th>Qty</th> <th>UOM</th> </tr> </thead> <tbody> <tr> <td>VL1065A1</td> <td>1/4 MALE N.O. PRESSURE SWITCH</td> <td>1</td> <td>PZ</td> </tr> </tbody> </table>	Code	Description	Qty	UOM	VL1065A1	1/4 MALE N.O. PRESSURE SWITCH	1	PZ								
Code	Description	Qty	UOM																		
VL1065A1	1/4 MALE N.O. PRESSURE SWITCH	1	PZ																		
VL1081A	D6 BARBED NO RETURN VALVE		KVL1128A	D6 VNR BARBED VALVE KIT	<table border="1"> <thead> <tr> <th>Code</th> <th>Description</th> <th>Qty</th> <th>UOM</th> </tr> </thead> <tbody> <tr> <td>RC1019A0</td> <td>D=10 ELASTIC CLAMP</td> <td>2</td> <td>PZ</td> </tr> <tr> <td>TB2820A0</td> <td>PIPE EPDM FOR WASHING SYSTEM</td> <td>0.080</td> <td>M</td> </tr> <tr> <td>VL1128A0</td> <td>BARBED CHECK VALVE D6</td> <td>1</td> <td>PZ</td> </tr> </tbody> </table>	Code	Description	Qty	UOM	RC1019A0	D=10 ELASTIC CLAMP	2	PZ	TB2820A0	PIPE EPDM FOR WASHING SYSTEM	0.080	M	VL1128A0	BARBED CHECK VALVE D6	1	PZ
Code	Description	Qty	UOM																		
RC1019A0	D=10 ELASTIC CLAMP	2	PZ																		
TB2820A0	PIPE EPDM FOR WASHING SYSTEM	0.080	M																		
VL1128A0	BARBED CHECK VALVE D6	1	PZ																		
			KVL1102A	DETERGENT FILTER + NRV KIT	<table border="1"> <thead> <tr> <th>Code</th> <th>Description</th> <th>Qty</th> <th>UOM</th> </tr> </thead> <tbody> <tr> <td>RC1019A0</td> <td>D=10 ELASTIC CLAMP</td> <td>3</td> <td>PZ</td> </tr> </tbody> </table>	Code	Description	Qty	UOM	RC1019A0	D=10 ELASTIC CLAMP	3	PZ								
Code	Description	Qty	UOM																		
RC1019A0	D=10 ELASTIC CLAMP	3	PZ																		





COMPONENT			SPARE PART																														
Code	Description	Image	Code	Description	Components list																												
VL1081A	D6 BARBED NO RETURN VALVE		KVL1102A	DETERGENT FILTER + NRV KIT	<table border="1"> <thead> <tr> <th>Code</th> <th>Description</th> <th>Qty</th> <th>UOM</th> </tr> </thead> <tbody> <tr> <td>TB2820A0</td> <td>PIPE EPDM FOR WASHING SYSTEM</td> <td>0.110</td> <td>M</td> </tr> <tr> <td>VL1102A0</td> <td></td> <td>1</td> <td>PZ</td> </tr> <tr> <td>VL1102A1</td> <td>DETERGENT LINE FILTER + BARBED VNR 6 MM</td> <td>1</td> <td>PZ</td> </tr> </tbody> </table>	Code	Description	Qty	UOM	TB2820A0	PIPE EPDM FOR WASHING SYSTEM	0.110	M	VL1102A0		1	PZ	VL1102A1	DETERGENT LINE FILTER + BARBED VNR 6 MM	1	PZ												
			Code	Description	Qty	UOM																											
TB2820A0	PIPE EPDM FOR WASHING SYSTEM	0.110	M																														
VL1102A0		1	PZ																														
VL1102A1	DETERGENT LINE FILTER + BARBED VNR 6 MM	1	PZ																														
KVL1081A	D6 BARBED NO RETURN VALVE 2PCS KIT	<table border="1"> <thead> <tr> <th>Code</th> <th>Description</th> <th>Qty</th> <th>UOM</th> </tr> </thead> <tbody> <tr> <td>TB2820A0</td> <td>PIPE EPDM FOR WASHING SYSTEM</td> <td>0.240</td> <td>M</td> </tr> <tr> <td>VL1081A0</td> <td>D6 BARBED NO RETURN VALVE</td> <td>3</td> <td>PZ</td> </tr> </tbody> </table>	Code	Description	Qty	UOM	TB2820A0	PIPE EPDM FOR WASHING SYSTEM	0.240	M	VL1081A0	D6 BARBED NO RETURN VALVE	3	PZ																			
Code	Description	Qty	UOM																														
TB2820A0	PIPE EPDM FOR WASHING SYSTEM	0.240	M																														
VL1081A0	D6 BARBED NO RETURN VALVE	3	PZ																														
VL1083A	D=10 CONNECTION - D=6 PIPE FITTING		KVL1083A	Ø8 CONNECTION-Ø6 BARBED PIPE HOLDER	<table border="1"> <thead> <tr> <th>Code</th> <th>Description</th> <th>Qty</th> <th>UOM</th> </tr> </thead> <tbody> <tr> <td>VL1083A0</td> <td>D=10 CONNECTION - D=6 PIPE FITTING</td> <td>1</td> <td>PZ</td> </tr> </tbody> </table>	Code	Description	Qty	UOM	VL1083A0	D=10 CONNECTION - D=6 PIPE FITTING	1	PZ																				
Code	Description	Qty	UOM																														
VL1083A0	D=10 CONNECTION - D=6 PIPE FITTING	1	PZ																														
RC1242A	D=10 CLOSED CAP		KRC1242A	Ø10 CLOSED CONNECTION 20PCS KIT	<table border="1"> <thead> <tr> <th>Code</th> <th>Description</th> <th>Qty</th> <th>UOM</th> </tr> </thead> <tbody> <tr> <td>RC1242A0</td> <td>D=10 CLOSED CAP</td> <td>20</td> <td>PZ</td> </tr> </tbody> </table>	Code	Description	Qty	UOM	RC1242A0	D=10 CLOSED CAP	20	PZ																				
Code	Description	Qty	UOM																														
RC1242A0	D=10 CLOSED CAP	20	PZ																														
VL1064A	WASHING SYSTEM OUTLETS DISTRIBUTOR		KVL1092A	EUR 2 ROTOR ARMS PLUS CHEMICAL PUMP KIT	<table border="1"> <thead> <tr> <th>Code</th> <th>Description</th> <th>Qty</th> <th>UOM</th> </tr> </thead> <tbody> <tr> <td>GN1526A0</td> <td>INT. D.=6.9 TH=1.8 O-RIN</td> <td>1</td> <td>PZ</td> </tr> <tr> <td>RC1019A0</td> <td>D=10 ELASTIC CLAMP</td> <td>4</td> <td>PZ</td> </tr> <tr> <td>RC1130A0</td> <td>130X2.6 CLAM</td> <td>1</td> <td>PZ</td> </tr> <tr> <td>RC1242A0</td> <td>D=10 CLOSED CAP</td> <td>2</td> <td>PZ</td> </tr> <tr> <td>RC1408A0</td> <td>DOUBLE WIRE SPRING CLAMP D10.8 ZN</td> <td>4</td> <td>PZ</td> </tr> <tr> <td>TB2820A0</td> <td>PIPE EPDM FOR WASHING SYSTEM</td> <td>0.120</td> <td>M</td> </tr> </tbody> </table>	Code	Description	Qty	UOM	GN1526A0	INT. D.=6.9 TH=1.8 O-RIN	1	PZ	RC1019A0	D=10 ELASTIC CLAMP	4	PZ	RC1130A0	130X2.6 CLAM	1	PZ	RC1242A0	D=10 CLOSED CAP	2	PZ	RC1408A0	DOUBLE WIRE SPRING CLAMP D10.8 ZN	4	PZ	TB2820A0	PIPE EPDM FOR WASHING SYSTEM	0.120	M
Code	Description	Qty	UOM																														
GN1526A0	INT. D.=6.9 TH=1.8 O-RIN	1	PZ																														
RC1019A0	D=10 ELASTIC CLAMP	4	PZ																														
RC1130A0	130X2.6 CLAM	1	PZ																														
RC1242A0	D=10 CLOSED CAP	2	PZ																														
RC1408A0	DOUBLE WIRE SPRING CLAMP D10.8 ZN	4	PZ																														
TB2820A0	PIPE EPDM FOR WASHING SYSTEM	0.120	M																														



COMPONENT			SPARE PART																																																			
Code	Description	Image	Code	Description	Components list																																																	
VL1064A	WASHING SYSTEM OUTLETS DISTRIBUTOR		KVL1092A	EUR 2 ROTOR ARMS PLUS CHEMICAL PUMP KIT	<table border="1"> <thead> <tr> <th>Code</th> <th>Description</th> <th>Qty</th> <th>UOM</th> </tr> </thead> <tbody> <tr> <td>VI1220A1</td> <td>4,2X12 TCB SELF-TAPPIN G SCREW</td> <td>2</td> <td>PZ</td> </tr> <tr> <td>VL1019A0</td> <td>VIBRATION PUMP</td> <td>1</td> <td>PZ</td> </tr> <tr> <td>VL1067A0</td> <td>WASHING SYSTEM INLETS DISTRIBUTOR</td> <td>1</td> <td>PZ</td> </tr> <tr> <td>VL1081A0</td> <td>D6 BARBED NO RETURN VALVE</td> <td>1</td> <td>PZ</td> </tr> <tr> <td>VL1092A0</td> <td>WASHING SYSTEM OUTLET DOUBLE DISTRIBUTOR</td> <td>1</td> <td>PZ</td> </tr> <tr> <td>VL1128A0</td> <td>BARBED CHECK VALVE D6</td> <td>1</td> <td>PZ</td> </tr> <tr> <td>VM2172A0</td> <td>PUMP LOCKING CLIP</td> <td>1</td> <td>PZ</td> </tr> </tbody> </table>	Code	Description	Qty	UOM	VI1220A1	4,2X12 TCB SELF-TAPPIN G SCREW	2	PZ	VL1019A0	VIBRATION PUMP	1	PZ	VL1067A0	WASHING SYSTEM INLETS DISTRIBUTOR	1	PZ	VL1081A0	D6 BARBED NO RETURN VALVE	1	PZ	VL1092A0	WASHING SYSTEM OUTLET DOUBLE DISTRIBUTOR	1	PZ	VL1128A0	BARBED CHECK VALVE D6	1	PZ	VM2172A0	PUMP LOCKING CLIP	1	PZ																	
			Code	Description	Qty	UOM																																																
VI1220A1	4,2X12 TCB SELF-TAPPIN G SCREW	2	PZ																																																			
VL1019A0	VIBRATION PUMP	1	PZ																																																			
VL1067A0	WASHING SYSTEM INLETS DISTRIBUTOR	1	PZ																																																			
VL1081A0	D6 BARBED NO RETURN VALVE	1	PZ																																																			
VL1092A0	WASHING SYSTEM OUTLET DOUBLE DISTRIBUTOR	1	PZ																																																			
VL1128A0	BARBED CHECK VALVE D6	1	PZ																																																			
VM2172A0	PUMP LOCKING CLIP	1	PZ																																																			
KVL1073A	EUR 1 ROTOR ARM PLUS CHEMICAL PUMP KIT	<table border="1"> <thead> <tr> <th>Code</th> <th>Description</th> <th>Qty</th> <th>UOM</th> </tr> </thead> <tbody> <tr> <td>GN1526A0</td> <td>INT. D.=6.9 TH=1.8 O-RIN</td> <td>1</td> <td>PZ</td> </tr> <tr> <td>RC1019A0</td> <td>D=10 ELASTIC CLAMP</td> <td>4</td> <td>PZ</td> </tr> <tr> <td>RC1130A0</td> <td>130X2,6 CLAM</td> <td>1</td> <td>PZ</td> </tr> <tr> <td>RC1242A0</td> <td>D=10 CLOSED CAP</td> <td>2</td> <td>PZ</td> </tr> <tr> <td>RC1408A0</td> <td>DOUBLE WIRE SPRING CLAMP D10.8 ZN</td> <td>2</td> <td>PZ</td> </tr> <tr> <td>TB2820A0</td> <td>PIPE EPDM FOR WASHING SYSTEM</td> <td>0.120</td> <td>M</td> </tr> <tr> <td>VL1019A0</td> <td>VIBRATION PUMP</td> <td>1</td> <td>PZ</td> </tr> <tr> <td>VL1064A0</td> <td>WASHING SYSTEM OUTLETS DISTRIBUTOR</td> <td>1</td> <td>PZ</td> </tr> <tr> <td>VL1067A0</td> <td>WASHING SYSTEM INLETS DISTRIBUTOR</td> <td>1</td> <td>PZ</td> </tr> <tr> <td>VL1081A0</td> <td>D6 BARBED NO RETURN VALVE</td> <td>1</td> <td>PZ</td> </tr> <tr> <td>VL1128A0</td> <td>BARBED CHECK VALVE D6</td> <td>1</td> <td>PZ</td> </tr> <tr> <td>VM2172A0</td> <td>PUMP LOCKING CLIP</td> <td>1</td> <td>PZ</td> </tr> </tbody> </table>	Code	Description	Qty	UOM	GN1526A0	INT. D.=6.9 TH=1.8 O-RIN	1	PZ	RC1019A0	D=10 ELASTIC CLAMP	4	PZ	RC1130A0	130X2,6 CLAM	1	PZ	RC1242A0	D=10 CLOSED CAP	2	PZ	RC1408A0	DOUBLE WIRE SPRING CLAMP D10.8 ZN	2	PZ	TB2820A0	PIPE EPDM FOR WASHING SYSTEM	0.120	M	VL1019A0	VIBRATION PUMP	1	PZ	VL1064A0	WASHING SYSTEM OUTLETS DISTRIBUTOR	1	PZ	VL1067A0	WASHING SYSTEM INLETS DISTRIBUTOR	1	PZ	VL1081A0	D6 BARBED NO RETURN VALVE	1	PZ	VL1128A0	BARBED CHECK VALVE D6	1	PZ	VM2172A0	PUMP LOCKING CLIP	1	PZ
Code	Description	Qty	UOM																																																			
GN1526A0	INT. D.=6.9 TH=1.8 O-RIN	1	PZ																																																			
RC1019A0	D=10 ELASTIC CLAMP	4	PZ																																																			
RC1130A0	130X2,6 CLAM	1	PZ																																																			
RC1242A0	D=10 CLOSED CAP	2	PZ																																																			
RC1408A0	DOUBLE WIRE SPRING CLAMP D10.8 ZN	2	PZ																																																			
TB2820A0	PIPE EPDM FOR WASHING SYSTEM	0.120	M																																																			
VL1019A0	VIBRATION PUMP	1	PZ																																																			
VL1064A0	WASHING SYSTEM OUTLETS DISTRIBUTOR	1	PZ																																																			
VL1067A0	WASHING SYSTEM INLETS DISTRIBUTOR	1	PZ																																																			
VL1081A0	D6 BARBED NO RETURN VALVE	1	PZ																																																			
VL1128A0	BARBED CHECK VALVE D6	1	PZ																																																			
VM2172A0	PUMP LOCKING CLIP	1	PZ																																																			



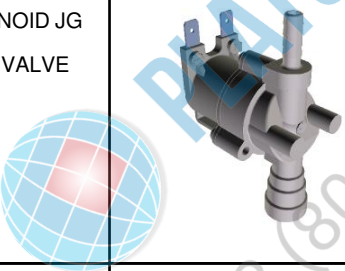
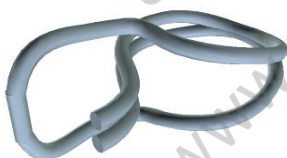

COMPONENT			SPARE PART																		
Code	Description	Image	Code	Description	Components list																
VL1064A	WASHING SYSTEM OUTLETS DISTRIBUTOR		KVL1064A	PLUS WASHING DISTRIBUTOR OUTLETS KIT	<table border="1"> <thead> <tr> <th>Code</th> <th>Description</th> <th>Qty</th> <th>UOM</th> </tr> </thead> <tbody> <tr> <td>VL1064A0</td> <td>WASHING SYSTEM OUTLETS DISTRIBUTOR</td> <td>1</td> <td>PZ</td> </tr> </tbody> </table>	Code	Description	Qty	UOM	VL1064A0	WASHING SYSTEM OUTLETS DISTRIBUTOR	1	PZ								
Code	Description	Qty	UOM																		
VL1064A0	WASHING SYSTEM OUTLETS DISTRIBUTOR	1	PZ																		
EL1424A	D8 CONNECTION WATER SOLENOID VALVE		KEL1436A  KEL1424A	D8 CONNECTION D6 SOLEN.VALVE KIT  EG1 JG D8-D6 SOLENOID VALVE KI	<table border="1"> <thead> <tr> <th>Code</th> <th>Description</th> <th>Qty</th> <th>UOM</th> </tr> </thead> <tbody> <tr> <td>EL1436A0</td> <td>H2O SOLENOID JG D8 CHECK VALVE</td> <td>1</td> <td>PZ</td> </tr> <tr> <td>EL1424A0</td> <td>D8 CONNECTION WATER SOLENOID VALVE</td> <td>1</td> <td>PZ</td> </tr> <tr> <td>VI1095A0</td> <td>3,9X9,5 SELF-THREADI NG SCREW</td> <td>2</td> <td>PZ</td> </tr> </tbody> </table>	Code	Description	Qty	UOM	EL1436A0	H2O SOLENOID JG D8 CHECK VALVE	1	PZ	EL1424A0	D8 CONNECTION WATER SOLENOID VALVE	1	PZ	VI1095A0	3,9X9,5 SELF-THREADI NG SCREW	2	PZ
Code	Description	Qty	UOM																		
EL1436A0	H2O SOLENOID JG D8 CHECK VALVE	1	PZ																		
EL1424A0	D8 CONNECTION WATER SOLENOID VALVE	1	PZ																		
VI1095A0	3,9X9,5 SELF-THREADI NG SCREW	2	PZ																		
EL1252A	1 WAY WATER VALVE + J.G. CONNECTION		KEL1252A	EL2 JG D8-D10 1 WAY SOLENOID VALVE KIT	<table border="1"> <thead> <tr> <th>Code</th> <th>Description</th> <th>Qty</th> <th>UOM</th> </tr> </thead> <tbody> <tr> <td>EL1252A1</td> <td>1 WAY WATER VALVE + J.G. CONNECTION</td> <td>1</td> <td>PZ</td> </tr> </tbody> </table>	Code	Description	Qty	UOM	EL1252A1	1 WAY WATER VALVE + J.G. CONNECTION	1	PZ								
Code	Description	Qty	UOM																		
EL1252A1	1 WAY WATER VALVE + J.G. CONNECTION	1	PZ																		
TB3005A	TB2820A-DET PLUS PIPE FOR FAN GUARD BACK		KTB1344A  KTB1343A	TB2820A0 6X10 EPM PIPE 100M KIT  TB2820A0 6X10 EPM PIPE 3M KIT	<table border="1"> <thead> <tr> <th>Code</th> <th>Description</th> <th>Qty</th> <th>UOM</th> </tr> </thead> <tbody> <tr> <td>TB2820A0</td> <td>PIPE EPDM FOR WASHING SYSTEM</td> <td>100</td> <td>M</td> </tr> <tr> <td>VM1059A1</td> <td>HEAT SHRINK FILM H800</td> <td>1.500</td> <td>M</td> </tr> <tr> <td>TB2820A0</td> <td>PIPE EPDM FOR WASHING SYSTEM</td> <td>3</td> <td>M</td> </tr> </tbody> </table>	Code	Description	Qty	UOM	TB2820A0	PIPE EPDM FOR WASHING SYSTEM	100	M	VM1059A1	HEAT SHRINK FILM H800	1.500	M	TB2820A0	PIPE EPDM FOR WASHING SYSTEM	3	M
Code	Description	Qty	UOM																		
TB2820A0	PIPE EPDM FOR WASHING SYSTEM	100	M																		
VM1059A1	HEAT SHRINK FILM H800	1.500	M																		
TB2820A0	PIPE EPDM FOR WASHING SYSTEM	3	M																		

COMPONENT			SPARE PART										
Code	Description	Image	Code	Description	Components list								
TB3025A			KTB1349A	8X4.75 BLUE PE WATER INLET PIPE L30M KIT	<table border="1"> <thead> <tr> <th>Code</th> <th>Description</th> <th>Qty</th> <th>UOM</th> </tr> </thead> <tbody> <tr> <td>TB1818A0</td> <td>8X4.75 BLUE PE WATER INLET PIPE</td> <td>30</td> <td>M</td> </tr> </tbody> </table>	Code	Description	Qty	UOM	TB1818A0	8X4.75 BLUE PE WATER INLET PIPE	30	M
Code	Description	Qty	UOM										
TB1818A0	8X4.75 BLUE PE WATER INLET PIPE	30	M										
TB3026A			KTB1349A	8X4.75 BLUE PE WATER INLET PIPE L30M KIT	<table border="1"> <thead> <tr> <th>Code</th> <th>Description</th> <th>Qty</th> <th>UOM</th> </tr> </thead> <tbody> <tr> <td>TB1818A0</td> <td>8X4.75 BLUE PE WATER INLET PIPE</td> <td>30</td> <td>M</td> </tr> </tbody> </table>	Code	Description	Qty	UOM	TB1818A0	8X4.75 BLUE PE WATER INLET PIPE	30	M
Code	Description	Qty	UOM										
TB1818A0	8X4.75 BLUE PE WATER INLET PIPE	30	M										
EL1436A	H2O SOLENOID JG D8 CHECK VALVE		KEL1436A	D8 CONNECTION D6 SOLEN.VALVE KIT	<table border="1"> <thead> <tr> <th>Code</th> <th>Description</th> <th>Qty</th> <th>UOM</th> </tr> </thead> <tbody> <tr> <td>EL1436A0</td> <td>H2O SOLENOID JG D8 CHECK VALVE</td> <td>1</td> <td>PZ</td> </tr> </tbody> </table>	Code	Description	Qty	UOM	EL1436A0	H2O SOLENOID JG D8 CHECK VALVE	1	PZ
Code	Description	Qty	UOM										
EL1436A0	H2O SOLENOID JG D8 CHECK VALVE	1	PZ										
RC1408A	DOUBLE WIRE SPRING CLAMP D10.8 ZN		KRC1408A	4 PCS D10.8 DOUBLE WIRE SPRING CLAMP KIT	<table border="1"> <thead> <tr> <th>Code</th> <th>Description</th> <th>Qty</th> <th>UOM</th> </tr> </thead> <tbody> <tr> <td>RC1408A0</td> <td>DOUBLE WIRE SPRING CLAMP D10.8 ZN</td> <td>4</td> <td>PZ</td> </tr> </tbody> </table>	Code	Description	Qty	UOM	RC1408A0	DOUBLE WIRE SPRING CLAMP D10.8 ZN	4	PZ
Code	Description	Qty	UOM										
RC1408A0	DOUBLE WIRE SPRING CLAMP D10.8 ZN	4	PZ										
TB3004A	TB2820A-PLUS DETERGENT COIL L=0,5M		KTB3004A	PLUS DETERGENT PIPE COIL ROTOR KI	<table border="1"> <thead> <tr> <th>Code</th> <th>Description</th> <th>Qty</th> <th>UOM</th> </tr> </thead> <tbody> <tr> <td>TB2820A0</td> <td>PIPE EPDM FOR WASHING SYSTEM</td> <td>0.500</td> <td>M</td> </tr> </tbody> </table>	Code	Description	Qty	UOM	TB2820A0	PIPE EPDM FOR WASHING SYSTEM	0.500	M
Code	Description	Qty	UOM										
TB2820A0	PIPE EPDM FOR WASHING SYSTEM	0.500	M										

COMPONENT			SPARE PART																						
Code	Description	Image	Code	Description	Components list																				
VL1102A			KVL1102A	DETERGENT FILTER + NRV KIT	<table border="1"> <thead> <tr> <th>Code</th> <th>Description</th> <th>Qty</th> <th>UOM</th> </tr> </thead> <tbody> <tr> <td>RC1019A0</td> <td>D=10 ELASTIC CLAMP</td> <td>3</td> <td>PZ</td> </tr> <tr> <td>TB2820A0</td> <td>PIPE EPDM FOR WASHING SYSTEM</td> <td>0.110</td> <td>M</td> </tr> <tr> <td>VL1102A0</td> <td></td> <td>1</td> <td>PZ</td> </tr> <tr> <td>VL1102A1</td> <td>DETERGENT LINE FILTER + BARBED VNR 6 MM</td> <td>1</td> <td>PZ</td> </tr> </tbody> </table>	Code	Description	Qty	UOM	RC1019A0	D=10 ELASTIC CLAMP	3	PZ	TB2820A0	PIPE EPDM FOR WASHING SYSTEM	0.110	M	VL1102A0		1	PZ	VL1102A1	DETERGENT LINE FILTER + BARBED VNR 6 MM	1	PZ
Code	Description	Qty	UOM																						
RC1019A0	D=10 ELASTIC CLAMP	3	PZ																						
TB2820A0	PIPE EPDM FOR WASHING SYSTEM	0.110	M																						
VL1102A0		1	PZ																						
VL1102A1	DETERGENT LINE FILTER + BARBED VNR 6 MM	1	PZ																						
TB3225B	TB2820A-TANK-WAS HYNG SYS CONNECTION		TB3225B0	TB2820A-TANK-WAS HYNG SYS CONNECTION																					
VM2074A	DRIP TRAY FIXING CLIP WITH SCREW		KVM1220A	CT/BT DRIP TRAY FIXING CLIPS 4PCS KIT	<table border="1"> <thead> <tr> <th>Code</th> <th>Description</th> <th>Qty</th> <th>UOM</th> </tr> </thead> <tbody> <tr> <td>V11220A1</td> <td>4,2X12 TCB SELF-TAPPING SCREW</td> <td>4</td> <td>PZ</td> </tr> <tr> <td>VM1220A0</td> <td>CLIP TO FIX DRIP TRAY C.T</td> <td>4</td> <td>PZ</td> </tr> <tr> <td>VM2074A0</td> <td>DRIP TRAY FIXING CLIP WITH SCREW</td> <td>4</td> <td>PZ</td> </tr> </tbody> </table>	Code	Description	Qty	UOM	V11220A1	4,2X12 TCB SELF-TAPPING SCREW	4	PZ	VM1220A0	CLIP TO FIX DRIP TRAY C.T	4	PZ	VM2074A0	DRIP TRAY FIXING CLIP WITH SCREW	4	PZ				
Code	Description	Qty	UOM																						
V11220A1	4,2X12 TCB SELF-TAPPING SCREW	4	PZ																						
VM1220A0	CLIP TO FIX DRIP TRAY C.T	4	PZ																						
VM2074A0	DRIP TRAY FIXING CLIP WITH SCREW	4	PZ																						
VM2249A	COOKING CHAMBER FRONT CORNER		KVM2249A	CHAMBER FRONT PROFILE CORNER KIT	<table border="1"> <thead> <tr> <th>Code</th> <th>Description</th> <th>Qty</th> <th>UOM</th> </tr> </thead> <tbody> <tr> <td>VM2249A0</td> <td>COOKING CHAMBER FRONT CORNER</td> <td>1</td> <td>PZ</td> </tr> </tbody> </table>	Code	Description	Qty	UOM	VM2249A0	COOKING CHAMBER FRONT CORNER	1	PZ												
Code	Description	Qty	UOM																						
VM2249A0	COOKING CHAMBER FRONT CORNER	1	PZ																						
VM2035A	DRAIN PIPE SUPPORT		KVM2035A	DRAIN PIPE SUPPORT 2 PCS. KI	<table border="1"> <thead> <tr> <th>Code</th> <th>Description</th> <th>Qty</th> <th>UOM</th> </tr> </thead> <tbody> <tr> <td>VM2035A0</td> <td>DRAIN PIPE SUPPORT</td> <td>2</td> <td>PZ</td> </tr> </tbody> </table>	Code	Description	Qty	UOM	VM2035A0	DRAIN PIPE SUPPORT	2	PZ												
Code	Description	Qty	UOM																						
VM2035A0	DRAIN PIPE SUPPORT	2	PZ																						



COMPONENT			SPARE PART										
Code	Description	Image	Code	Description	Components list								
VM1810A	WATER RIGHT SEALING CAP		VM1810A0	WATER RIGHT SEALING CAP									
VM1811A	WATER LEFT SEALING CAP		VM1811A0	WATER LEFT SEALING CAP									
VM2280A	DOOR LATCH COVE		KVM2280A	VM2280A HANDLE LATCH PLATE COVER KIT	<table border="1"> <thead> <tr> <th>Code</th> <th>Description</th> <th>Qty</th> <th>UOM</th> </tr> </thead> <tbody> <tr> <td>VM2280A0</td> <td>DOOR LATCH COVER</td> <td>1</td> <td>PZ</td> </tr> </tbody> </table>	Code	Description	Qty	UOM	VM2280A0	DOOR LATCH COVER	1	PZ
Code	Description	Qty	UOM										
VM2280A0	DOOR LATCH COVER	1	PZ										
VM2281A	DOOR LATCH HOLES COVER		KVM2281A	HOLE PLATE COVER KIT	<table border="1"> <thead> <tr> <th>Code</th> <th>Description</th> <th>Qty</th> <th>UOM</th> </tr> </thead> <tbody> <tr> <td>VM2281A0</td> <td>DOOR LATCH HOLES COVER</td> <td>1</td> <td>PZ</td> </tr> </tbody> </table>	Code	Description	Qty	UOM	VM2281A0	DOOR LATCH HOLES COVER	1	PZ
Code	Description	Qty	UOM										
VM2281A0	DOOR LATCH HOLES COVER	1	PZ										
VM2311A	SCREWS COVER		KVM2311A	SCREWS COVER PLATE KIT	<table border="1"> <thead> <tr> <th>Code</th> <th>Description</th> <th>Qty</th> <th>UOM</th> </tr> </thead> <tbody> <tr> <td>VM2311A0</td> <td>SCREWS COVER</td> <td>1</td> <td>PZ</td> </tr> </tbody> </table>	Code	Description	Qty	UOM	VM2311A0	SCREWS COVER	1	PZ
Code	Description	Qty	UOM										
VM2311A0	SCREWS COVER	1	PZ										

COMPONENT			SPARE PART																										
Code	Description	Image	Code	Description	Components list																								
VM1992A	E SERIES BAKERTOP DRIP TRAY		KVM1992A	E SERIES BAKERTOP DRIP TRAY	<table border="1"> <thead> <tr> <th>Code</th> <th>Description</th> <th>Qty</th> <th>UOM</th> </tr> </thead> <tbody> <tr> <td>VM1220A0</td> <td>CLIP TO FIX DRIP TRAY C.T</td> <td>4</td> <td>PZ</td> </tr> <tr> <td>VM1794A0</td> <td>250X4.8 PA66 BLACK CLAMP</td> <td>2</td> <td>PZ</td> </tr> <tr> <td>VM1992A0</td> <td>E SERIES BAKERTOP DRIP TRAY</td> <td>1</td> <td>PZ</td> </tr> <tr> <td>VM2074A0</td> <td>DRIP TRAY FIXING CLIP WITH SCREW</td> <td>4</td> <td>PZ</td> </tr> <tr> <td>VM2103A0</td> <td>CLAMP LOCK</td> <td>2</td> <td>PZ</td> </tr> </tbody> </table>	Code	Description	Qty	UOM	VM1220A0	CLIP TO FIX DRIP TRAY C.T	4	PZ	VM1794A0	250X4.8 PA66 BLACK CLAMP	2	PZ	VM1992A0	E SERIES BAKERTOP DRIP TRAY	1	PZ	VM2074A0	DRIP TRAY FIXING CLIP WITH SCREW	4	PZ	VM2103A0	CLAMP LOCK	2	PZ
Code	Description	Qty	UOM																										
VM1220A0	CLIP TO FIX DRIP TRAY C.T	4	PZ																										
VM1794A0	250X4.8 PA66 BLACK CLAMP	2	PZ																										
VM1992A0	E SERIES BAKERTOP DRIP TRAY	1	PZ																										
VM2074A0	DRIP TRAY FIXING CLIP WITH SCREW	4	PZ																										
VM2103A0	CLAMP LOCK	2	PZ																										
VM2308A	PREMIX BOX COVER		VM2308A0	PREMIX BOX COVER																									
VM2061A	ACCESSORIES CABLES WALL PASSING		KVM1505A	THROUGH-WALL CONNECTION+DIAPHRAGM KIT	<table border="1"> <thead> <tr> <th>Code</th> <th>Description</th> <th>Qty</th> <th>UOM</th> </tr> </thead> <tbody> <tr> <td>VH1220A1</td> <td>4,2X12 TCB SELF-TAPPIN G SCREW</td> <td>1</td> <td>PZ</td> </tr> <tr> <td>VM1505A0</td> <td>WALL PASSING WITH DIAPHRAGM</td> <td>3</td> <td>PZ</td> </tr> <tr> <td>VM2055A0</td> <td>UPPER THROUGH-WA LL CONNECTION</td> <td>1</td> <td>PZ</td> </tr> <tr> <td>VM2056A0</td> <td>LOWER THROUGH-WA LL CONNECTION</td> <td>1</td> <td>PZ</td> </tr> <tr> <td>VM2061A0</td> <td>ACCESSORIES CABLES WALL PASSING</td> <td>1</td> <td>PZ</td> </tr> </tbody> </table>	Code	Description	Qty	UOM	VH1220A1	4,2X12 TCB SELF-TAPPIN G SCREW	1	PZ	VM1505A0	WALL PASSING WITH DIAPHRAGM	3	PZ	VM2055A0	UPPER THROUGH-WA LL CONNECTION	1	PZ	VM2056A0	LOWER THROUGH-WA LL CONNECTION	1	PZ	VM2061A0	ACCESSORIES CABLES WALL PASSING	1	PZ
Code	Description	Qty	UOM																										
VH1220A1	4,2X12 TCB SELF-TAPPIN G SCREW	1	PZ																										
VM1505A0	WALL PASSING WITH DIAPHRAGM	3	PZ																										
VM2055A0	UPPER THROUGH-WA LL CONNECTION	1	PZ																										
VM2056A0	LOWER THROUGH-WA LL CONNECTION	1	PZ																										
VM2061A0	ACCESSORIES CABLES WALL PASSING	1	PZ																										

ASM1854A/0.D02 - General overview

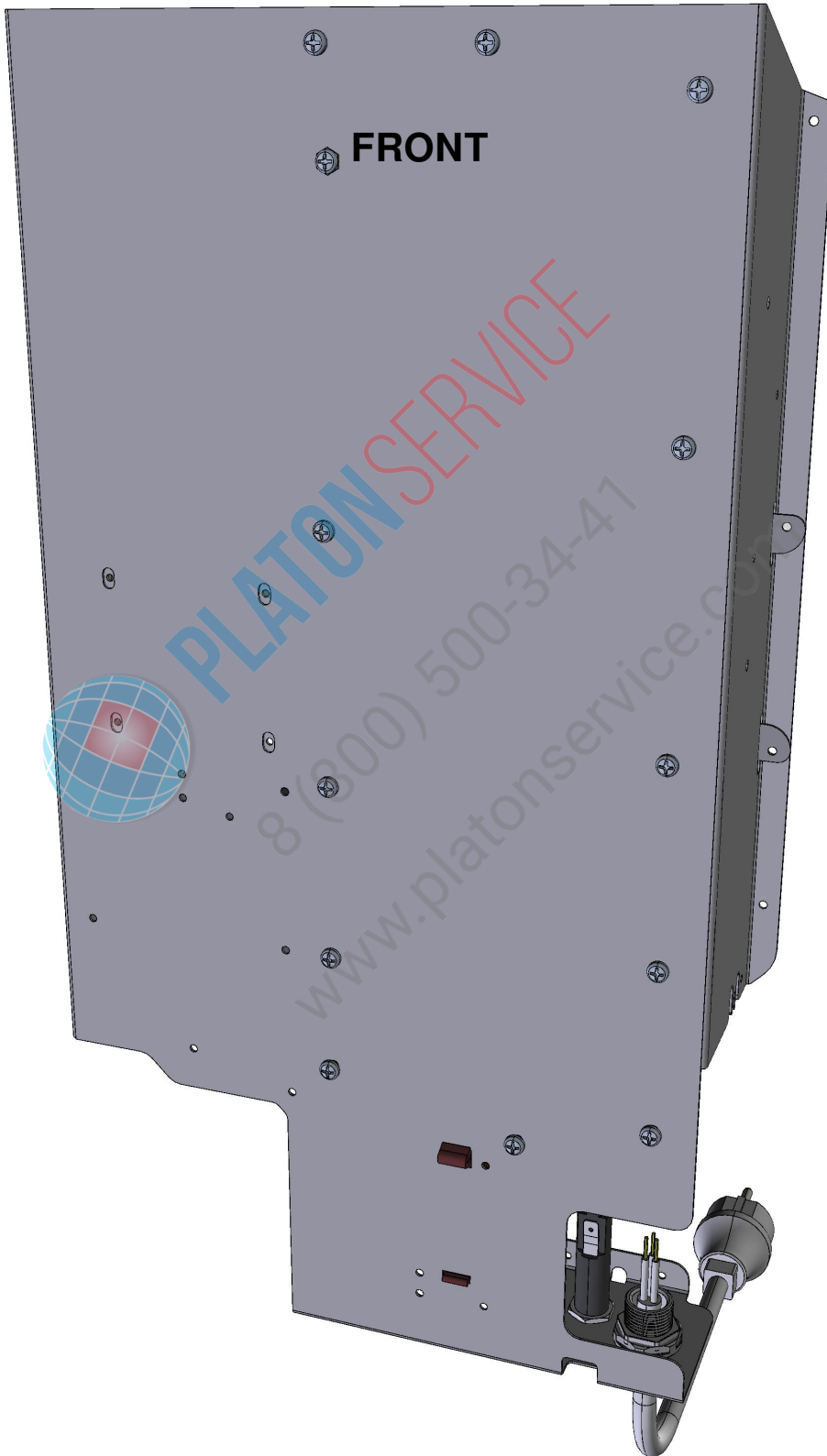

ASM1854A/0.D02 - General overview

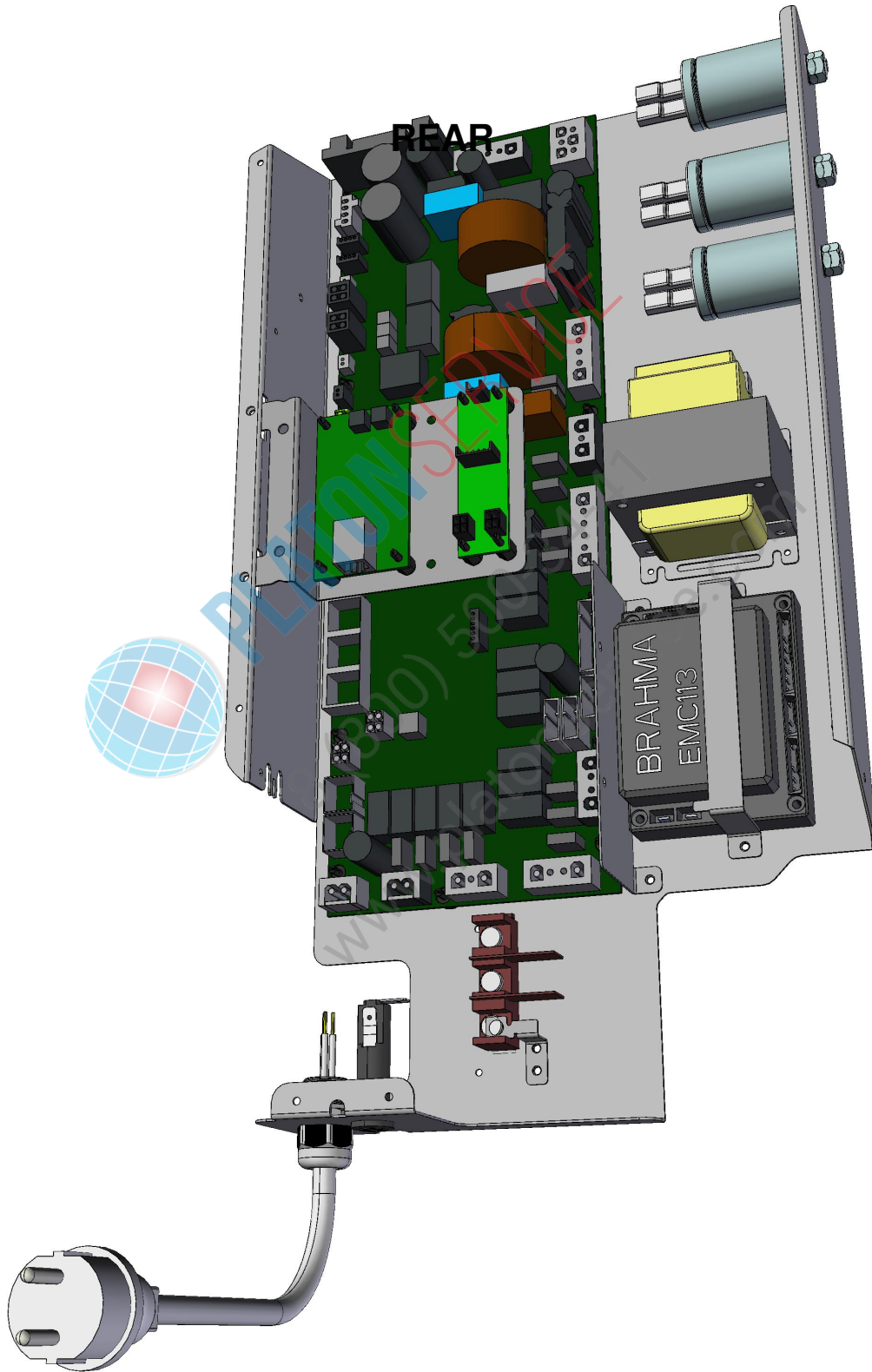



COMPONENT			SPARE PART																										
Code	Description	Image	Code	Description	Components list																								
CN1003A	6,3 UF MOTOR CAPACITOR		KCN1003A	6,3 UF MOTOR CAPACITOR KIT	<table border="1"> <thead> <tr> <th>Code</th> <th>Description</th> <th>Qty</th> <th>UOM</th> </tr> </thead> <tbody> <tr> <td>CN1003A0</td> <td>6,3 UF MOTOR CAPACITOR</td> <td>1</td> <td>PZ</td> </tr> <tr> <td>VI1931A0</td> <td>M8 NUT+INDENTE D WASHER D=8 X COND.</td> <td>1</td> <td>PZ</td> </tr> <tr> <td>VI1932A0</td> <td>M8 NUT+INDENTE D WASHER D=8 X COND.</td> <td>1</td> <td>PZ</td> </tr> </tbody> </table>	Code	Description	Qty	UOM	CN1003A0	6,3 UF MOTOR CAPACITOR	1	PZ	VI1931A0	M8 NUT+INDENTE D WASHER D=8 X COND.	1	PZ	VI1932A0	M8 NUT+INDENTE D WASHER D=8 X COND.	1	PZ								
Code	Description	Qty	UOM																										
CN1003A0	6,3 UF MOTOR CAPACITOR	1	PZ																										
VI1931A0	M8 NUT+INDENTE D WASHER D=8 X COND.	1	PZ																										
VI1932A0	M8 NUT+INDENTE D WASHER D=8 X COND.	1	PZ																										
VE1026A	230-21-12VAC 80VA TRANSFORMER		KVE1026A	230-21-12VAC 90VA TRANSFORMER KIT	<table border="1"> <thead> <tr> <th>Code</th> <th>Description</th> <th>Qty</th> <th>UOM</th> </tr> </thead> <tbody> <tr> <td>VE1026A0</td> <td>230-21-12VAC 80VA TRANSFORME</td> <td>1</td> <td>PZ</td> </tr> <tr> <td>VI1950A0</td> <td>ST. STEEL 4,2X13 TCB SELF-DRILLIN G SCREW</td> <td>4</td> <td>PZ</td> </tr> <tr> <td>VM2147A0</td> <td>ESD SPONGE PINK SMOOTH 410X343X15 M</td> <td>1</td> <td>PZ</td> </tr> </tbody> </table>	Code	Description	Qty	UOM	VE1026A0	230-21-12VAC 80VA TRANSFORME	1	PZ	VI1950A0	ST. STEEL 4,2X13 TCB SELF-DRILLIN G SCREW	4	PZ	VM2147A0	ESD SPONGE PINK SMOOTH 410X343X15 M	1	PZ								
Code	Description	Qty	UOM																										
VE1026A0	230-21-12VAC 80VA TRANSFORME	1	PZ																										
VI1950A0	ST. STEEL 4,2X13 TCB SELF-DRILLIN G SCREW	4	PZ																										
VM2147A0	ESD SPONGE PINK SMOOTH 410X343X15 M	1	PZ																										
0H7293A	GROUND CONNECTOR FIXING PLATE																												
0H7374A	CORE PROBE CABLE PLATE		0H7374A0	CORE PROBE CABLE PLATE																									
VE1640A	FUSE HOLDING PANEL 6. 3X32		KVE1665A  KVE1661A	10X38 30A PANEL FUSE HOLDERS KIT  6.3X32 20A PANEL FUSE HOLDERS KIT	<table border="1"> <thead> <tr> <th>Code</th> <th>Description</th> <th>Qty</th> <th>UOM</th> </tr> </thead> <tbody> <tr> <td>VE1665A0</td> <td></td> <td>1</td> <td>PZ</td> </tr> <tr> <td>VE1667A0</td> <td></td> <td>1</td> <td>PZ</td> </tr> </tbody> </table> <table border="1"> <thead> <tr> <th>Code</th> <th>Description</th> <th>Qty</th> <th>UOM</th> </tr> </thead> <tbody> <tr> <td>0H7823A0</td> <td>FUSE HOLDER ADAPTER PLATE</td> <td>1</td> <td>PZ</td> </tr> <tr> <td>VE1661A0</td> <td>PANEL FUSE HOLDER 6,3X32 20A UL</td> <td>1</td> <td>PZ</td> </tr> </tbody> </table>	Code	Description	Qty	UOM	VE1665A0		1	PZ	VE1667A0		1	PZ	Code	Description	Qty	UOM	0H7823A0	FUSE HOLDER ADAPTER PLATE	1	PZ	VE1661A0	PANEL FUSE HOLDER 6,3X32 20A UL	1	PZ
Code	Description	Qty	UOM																										
VE1665A0		1	PZ																										
VE1667A0		1	PZ																										
Code	Description	Qty	UOM																										
0H7823A0	FUSE HOLDER ADAPTER PLATE	1	PZ																										
VE1661A0	PANEL FUSE HOLDER 6,3X32 20A UL	1	PZ																										

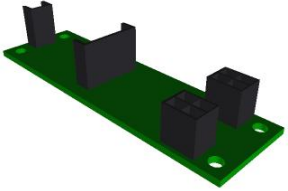
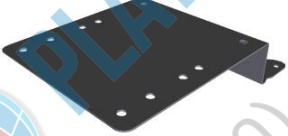

COMPONENT			SPARE PART																						
Code	Description	Image	Code	Description	Components list																				
VE1275A	STRAIN RELIEF PG 13.5		VE1275A0	STRAIN RELIEF PG 13.5																					
VE1280A	NUT WITH COLLAR FOR STRAIN RELIEF PG13,5		VE1280A0	NUT WITH COLLAR FOR STRAIN RELIEF PG13,5																					
PE2021A	MIND.MAPS GAS POWER CARD		KPE2021B	MIND.MAPS GAS PREMIX POWER BOARD KIT	<table border="1"> <thead> <tr> <th>Code</th> <th>Description</th> <th>Qty</th> <th>UOM</th> </tr> </thead> <tbody> <tr> <td>PE2021B0</td> <td>MIND.MAPS GAS POWER CARD</td> <td>1</td> <td>PZ</td> </tr> <tr> <td>V11850A0</td> <td>M4X6 NICKEL PLATED FIXING SCRE</td> <td>12</td> <td>PZ</td> </tr> <tr> <td>VM1745A0</td> <td>CARD SUPPORT</td> <td>12</td> <td>PZ</td> </tr> <tr> <td>VM2147A0</td> <td>ESD SPONGE PINK SMOOTH 410X343X15 M</td> <td>1</td> <td>PZ</td> </tr> </tbody> </table>	Code	Description	Qty	UOM	PE2021B0	MIND.MAPS GAS POWER CARD	1	PZ	V11850A0	M4X6 NICKEL PLATED FIXING SCRE	12	PZ	VM1745A0	CARD SUPPORT	12	PZ	VM2147A0	ESD SPONGE PINK SMOOTH 410X343X15 M	1	PZ
Code	Description	Qty	UOM																						
PE2021B0	MIND.MAPS GAS POWER CARD	1	PZ																						
V11850A0	M4X6 NICKEL PLATED FIXING SCRE	12	PZ																						
VM1745A0	CARD SUPPORT	12	PZ																						
VM2147A0	ESD SPONGE PINK SMOOTH 410X343X15 M	1	PZ																						
			KPE2021A	MIND.MAPS GAS PREMIX POWER BOARD KIT	<table border="1"> <thead> <tr> <th>Code</th> <th>Description</th> <th>Qty</th> <th>UOM</th> </tr> </thead> <tbody> <tr> <td>PE2021A0</td> <td>MIND.MAPS GAS POWER CARD</td> <td>1</td> <td>PZ</td> </tr> <tr> <td>V11850A0</td> <td>M4X6 NICKEL PLATED FIXING SCRE</td> <td>12</td> <td>PZ</td> </tr> <tr> <td>VM1745A0</td> <td>CARD SUPPORT</td> <td>12</td> <td>PZ</td> </tr> <tr> <td>VM2147A0</td> <td>ESD SPONGE PINK SMOOTH 410X343X15 M</td> <td>1</td> <td>PZ</td> </tr> </tbody> </table>	Code	Description	Qty	UOM	PE2021A0	MIND.MAPS GAS POWER CARD	1	PZ	V11850A0	M4X6 NICKEL PLATED FIXING SCRE	12	PZ	VM1745A0	CARD SUPPORT	12	PZ	VM2147A0	ESD SPONGE PINK SMOOTH 410X343X15 M	1	PZ
Code	Description	Qty	UOM																						
PE2021A0	MIND.MAPS GAS POWER CARD	1	PZ																						
V11850A0	M4X6 NICKEL PLATED FIXING SCRE	12	PZ																						
VM1745A0	CARD SUPPORT	12	PZ																						
VM2147A0	ESD SPONGE PINK SMOOTH 410X343X15 M	1	PZ																						

COMPONENT			SPARE PART																										
Code	Description	Image	Code	Description	Components list																								
CE1575A	MONOPHASIC CLIP TERMINAL BLOCK 41A																												
OH7462A	VE1636A GEARCASE STOPPING PLATE		OH7462A0	VE1636A GEARCASE STOPPING PLATE																									
VE1636A	240V 50/60HZ MULTIFLAME IGNITION BOX		KVE1636A	240V 50/60HZ MULTIFLAME IGNITION BOX KIT	<table border="1"> <thead> <tr> <th>Code</th> <th>Description</th> <th>Qty</th> <th>UOM</th> </tr> </thead> <tbody> <tr> <td>CE1047A0</td> <td>FLAME DETECTOR CANDLE CABL</td> <td>2</td> <td>PZ</td> </tr> <tr> <td>CE1047A1</td> <td>FLAME DETECTOR CANDLE CABL</td> <td>1</td> <td>PZ</td> </tr> <tr> <td>VE1636A0</td> <td>240V 50/60HZ MULTIFLAME IGNITION BOX</td> <td>1</td> <td>PZ</td> </tr> <tr> <td>VE1636A1</td> <td></td> <td>1</td> <td>PZ</td> </tr> </tbody> </table>	Code	Description	Qty	UOM	CE1047A0	FLAME DETECTOR CANDLE CABL	2	PZ	CE1047A1	FLAME DETECTOR CANDLE CABL	1	PZ	VE1636A0	240V 50/60HZ MULTIFLAME IGNITION BOX	1	PZ	VE1636A1		1	PZ				
Code	Description	Qty	UOM																										
CE1047A0	FLAME DETECTOR CANDLE CABL	2	PZ																										
CE1047A1	FLAME DETECTOR CANDLE CABL	1	PZ																										
VE1636A0	240V 50/60HZ MULTIFLAME IGNITION BOX	1	PZ																										
VE1636A1		1	PZ																										
PE2052A	MM LAN CONNECTION BRIDGE		XEC001	UNOX.LINK ETHERNET CONNECTION ONE/PLUS	<table border="1"> <thead> <tr> <th>Code</th> <th>Description</th> <th>Qty</th> <th>UOM</th> </tr> </thead> <tbody> <tr> <td>CE1065A0</td> <td>4X0.5 MICROFIT WIRE 4P-500MM-MIC ROFIT4P</td> <td>1</td> <td>PZ</td> </tr> <tr> <td>PE2052A0</td> <td>MM LAN CONNECTION BRIDGE</td> <td>1</td> <td>PZ</td> </tr> <tr> <td>VI1850A0</td> <td>M4X6 NICKEL PLATED FIXING SCRE</td> <td>6</td> <td>PZ</td> </tr> <tr> <td>VM1745A0</td> <td>CARD SUPPORT</td> <td>4</td> <td>PZ</td> </tr> <tr> <td>VM2147A0</td> <td>ESD SPONGE PINK SMOOTH 410X343X15 M</td> <td>1</td> <td>PZ</td> </tr> </tbody> </table>	Code	Description	Qty	UOM	CE1065A0	4X0.5 MICROFIT WIRE 4P-500MM-MIC ROFIT4P	1	PZ	PE2052A0	MM LAN CONNECTION BRIDGE	1	PZ	VI1850A0	M4X6 NICKEL PLATED FIXING SCRE	6	PZ	VM1745A0	CARD SUPPORT	4	PZ	VM2147A0	ESD SPONGE PINK SMOOTH 410X343X15 M	1	PZ
Code	Description	Qty	UOM																										
CE1065A0	4X0.5 MICROFIT WIRE 4P-500MM-MIC ROFIT4P	1	PZ																										
PE2052A0	MM LAN CONNECTION BRIDGE	1	PZ																										
VI1850A0	M4X6 NICKEL PLATED FIXING SCRE	6	PZ																										
VM1745A0	CARD SUPPORT	4	PZ																										
VM2147A0	ESD SPONGE PINK SMOOTH 410X343X15 M	1	PZ																										

COMPONENT			SPARE PART																										
Code	Description	Image	Code	Description	Components list																								
PE2057A	MM BRIDGE FUMES THERMOCOUPLE		KPE2057A	MIND.MAPS GAS FUMES BOARD KIT	<table border="1"> <thead> <tr> <th>Code</th> <th>Description</th> <th>Qty</th> <th>UOM</th> </tr> </thead> <tbody> <tr> <td>CE1065A0</td> <td>4X0.5 MICROFIT WIRE 4P-500MM-MIC ROFIT4P</td> <td>1</td> <td>PZ</td> </tr> <tr> <td>PE2057A0</td> <td>MM BRIDGE FUMES THERMOCOUPLE</td> <td>1</td> <td>PZ</td> </tr> <tr> <td>VI1850A0</td> <td>M4X6 NICKEL PLATED FIXING SCRE</td> <td>4</td> <td>PZ</td> </tr> <tr> <td>VM1745A0</td> <td>CARD SUPPORT</td> <td>1</td> <td>PZ</td> </tr> <tr> <td>VM2147A0</td> <td>ESD SPONGE PINK SMOOTH 410X343X15 M</td> <td>1</td> <td>PZ</td> </tr> </tbody> </table>	Code	Description	Qty	UOM	CE1065A0	4X0.5 MICROFIT WIRE 4P-500MM-MIC ROFIT4P	1	PZ	PE2057A0	MM BRIDGE FUMES THERMOCOUPLE	1	PZ	VI1850A0	M4X6 NICKEL PLATED FIXING SCRE	4	PZ	VM1745A0	CARD SUPPORT	1	PZ	VM2147A0	ESD SPONGE PINK SMOOTH 410X343X15 M	1	PZ
Code	Description	Qty	UOM																										
CE1065A0	4X0.5 MICROFIT WIRE 4P-500MM-MIC ROFIT4P	1	PZ																										
PE2057A0	MM BRIDGE FUMES THERMOCOUPLE	1	PZ																										
VI1850A0	M4X6 NICKEL PLATED FIXING SCRE	4	PZ																										
VM1745A0	CARD SUPPORT	1	PZ																										
VM2147A0	ESD SPONGE PINK SMOOTH 410X343X15 M	1	PZ																										
0H7451A	LAN SUPPORT PLAT		0H7451A0	LAN SUPPORT PLAT																									
0H7490A	VE1637A GEARCASE PROTECTING PLAT		0H7490A0	VE1637A GEARCASE PROTECTING PLAT																									
0H7452A	XEVC GAS COMPONENTS HOLDER PROFILE																												

ASM3008A/0.D06 - Door



ASM3008A/0.D06 - Door

REAR





COMPONENT			SPARE PART																																																																		
Code	Description	Image	Code	Description	Components list																																																																
MG1083A	MIND.MAPS DOOR COMPLETE HANDLE		KMG1083A	MM SERIES HANDLE KIT (REPLACES KVM1180B)	<table border="1"> <thead> <tr> <th>Code</th> <th>Description</th> <th>Qty</th> <th>UOM</th> </tr> </thead> <tbody> <tr> <td>0H7321A0</td> <td>MM STAINLESS STEEL HANDLE COVE</td> <td>1</td> <td>PZ</td> </tr> <tr> <td>RC1200A0</td> <td>ED=4 WIRE D.=0.5 COMPRESSIO N SPRING</td> <td>4</td> <td>PZ</td> </tr> <tr> <td>VI0239A1</td> <td>SELF-TAPPIN G SCREW 4.2X25 TCB+ INOX</td> <td>4</td> <td>PZ</td> </tr> <tr> <td>VI1220A1</td> <td>4,2X12 TCB SELF-TAPPIN G SCREW</td> <td>2</td> <td>PZ</td> </tr> <tr> <td>VM1182B0</td> <td>E S. CT BT HANDLE JUNCTION + PIN GUIDE</td> <td>1</td> <td>PZ</td> </tr> <tr> <td>VM1182B1</td> <td>E S. CT BT HANDLE JUNCTION + PIN GUIDE</td> <td>1</td> <td>PZ</td> </tr> <tr> <td>VM1183A1</td> <td>CHEFTOP/BAK ERTOP HANDLE PIN</td> <td>1</td> <td>PZ</td> </tr> <tr> <td>VM1183B0</td> <td>CHEFTOP/BAK ERTOP HANDLE PIN</td> <td>1</td> <td>PZ</td> </tr> <tr> <td>VM1490A0</td> <td>CHEFTOP/BAK ERTOP HANDLE SCREWS COVER</td> <td>2</td> <td>PZ</td> </tr> <tr> <td>VM1695A0</td> <td>HANDLE POSITION PIN</td> <td>4</td> <td>PZ</td> </tr> <tr> <td>VM2245A0</td> <td>HANDLE SHAFT WITH LATCH</td> <td>1</td> <td>PZ</td> </tr> <tr> <td>VM2247A0</td> <td>HANDLE SHAFT COVER VM2245-2246</td> <td>1</td> <td>PZ</td> </tr> <tr> <td>VM2248A0</td> <td>CLOSING HANDLE KEY WITH LATCH</td> <td>1</td> <td>PZ</td> </tr> <tr> <td>VM2248B0</td> <td>CLOSING HANDLE KEY WITH LATCH</td> <td>1</td> <td>PZ</td> </tr> <tr> <td>VM2295A0</td> <td>STYLUS PEN FOR MM</td> <td>1</td> <td>PZ</td> </tr> </tbody> </table>	Code	Description	Qty	UOM	0H7321A0	MM STAINLESS STEEL HANDLE COVE	1	PZ	RC1200A0	ED=4 WIRE D.=0.5 COMPRESSIO N SPRING	4	PZ	VI0239A1	SELF-TAPPIN G SCREW 4.2X25 TCB+ INOX	4	PZ	VI1220A1	4,2X12 TCB SELF-TAPPIN G SCREW	2	PZ	VM1182B0	E S. CT BT HANDLE JUNCTION + PIN GUIDE	1	PZ	VM1182B1	E S. CT BT HANDLE JUNCTION + PIN GUIDE	1	PZ	VM1183A1	CHEFTOP/BAK ERTOP HANDLE PIN	1	PZ	VM1183B0	CHEFTOP/BAK ERTOP HANDLE PIN	1	PZ	VM1490A0	CHEFTOP/BAK ERTOP HANDLE SCREWS COVER	2	PZ	VM1695A0	HANDLE POSITION PIN	4	PZ	VM2245A0	HANDLE SHAFT WITH LATCH	1	PZ	VM2247A0	HANDLE SHAFT COVER VM2245-2246	1	PZ	VM2248A0	CLOSING HANDLE KEY WITH LATCH	1	PZ	VM2248B0	CLOSING HANDLE KEY WITH LATCH	1	PZ	VM2295A0	STYLUS PEN FOR MM	1	PZ
					Code	Description	Qty	UOM																																																													
					0H7321A0	MM STAINLESS STEEL HANDLE COVE	1	PZ																																																													
					RC1200A0	ED=4 WIRE D.=0.5 COMPRESSIO N SPRING	4	PZ																																																													
					VI0239A1	SELF-TAPPIN G SCREW 4.2X25 TCB+ INOX	4	PZ																																																													
					VI1220A1	4,2X12 TCB SELF-TAPPIN G SCREW	2	PZ																																																													
					VM1182B0	E S. CT BT HANDLE JUNCTION + PIN GUIDE	1	PZ																																																													
					VM1182B1	E S. CT BT HANDLE JUNCTION + PIN GUIDE	1	PZ																																																													
					VM1183A1	CHEFTOP/BAK ERTOP HANDLE PIN	1	PZ																																																													
					VM1183B0	CHEFTOP/BAK ERTOP HANDLE PIN	1	PZ																																																													
					VM1490A0	CHEFTOP/BAK ERTOP HANDLE SCREWS COVER	2	PZ																																																													
					VM1695A0	HANDLE POSITION PIN	4	PZ																																																													
					VM2245A0	HANDLE SHAFT WITH LATCH	1	PZ																																																													
					VM2247A0	HANDLE SHAFT COVER VM2245-2246	1	PZ																																																													
					VM2248A0	CLOSING HANDLE KEY WITH LATCH	1	PZ																																																													
					VM2248B0	CLOSING HANDLE KEY WITH LATCH	1	PZ																																																													
					VM2295A0	STYLUS PEN FOR MM	1	PZ																																																													



COMPONENT			SPARE PART																																																						
Code	Description	Image	Code	Description	Components list																																																				
VM2274A	GROOVED BUSHING		KVM2274A	GROOVED PIN BUSHING KIT	<table border="1"> <thead> <tr> <th>Code</th> <th>Description</th> <th>Qty</th> <th>UOM</th> </tr> </thead> <tbody> <tr> <td>VM2274A0</td> <td>GROOVED BUSHING</td> <td>1</td> <td>PZ</td> </tr> </tbody> </table>	Code	Description	Qty	UOM	VM2274A0	GROOVED BUSHING	1	PZ																																												
Code	Description	Qty	UOM																																																						
VM2274A0	GROOVED BUSHING	1	PZ																																																						
			K0B1126AR	BAKERTOP RIGHT DOOR LOWER BEAM KIT	<table border="1"> <thead> <tr> <th>Code</th> <th>Description</th> <th>Qty</th> <th>UOM</th> </tr> </thead> <tbody> <tr> <td>0B1126A0</td> <td>DOOR LOWER FRAME SHAPE 860 MM</td> <td>1</td> <td>PZ</td> </tr> <tr> <td>RC1200A0</td> <td>ED=4 WIRE D.=0.5 COMPRESSIO N SPRING</td> <td>2</td> <td>PZ</td> </tr> <tr> <td>VI1220A1</td> <td>4,2X12 TCB SELF-TAPPIN G SCREW</td> <td>1</td> <td>PZ</td> </tr> <tr> <td>VI1996A0</td> <td>M5X35 SCREW</td> <td>7</td> <td>PZ</td> </tr> <tr> <td>VM1794A0</td> <td>250X4.8 PA66 BLACK CLAMP</td> <td>2</td> <td>PZ</td> </tr> <tr> <td>VM2103A0</td> <td>CLAMP LOCK</td> <td>2</td> <td>PZ</td> </tr> <tr> <td>VM2259A1</td> <td>6 SERIES DOOR LOWER LEFT CAP</td> <td>1</td> <td>PZ</td> </tr> <tr> <td>VM2261A1</td> <td>6 SERIES DOOR LOWER RIGHT CAP</td> <td>1</td> <td>PZ</td> </tr> <tr> <td>VM2267A0</td> <td>INTERNAL GLASS LOCKING SYSTEM SLIDER</td> <td>1</td> <td>PZ</td> </tr> <tr> <td>VM2269A0</td> <td>INTERNAL GLASS LOCKING SYSTEM CAP</td> <td>1</td> <td>PZ</td> </tr> <tr> <td>VM2274A0</td> <td>GROOVED BUSHING</td> <td>1</td> <td>PZ</td> </tr> <tr> <td>VM2305A0</td> <td>6 SERIES DOOR CAP FIXING PAWL</td> <td>7</td> <td>PZ</td> </tr> </tbody> </table>	Code	Description	Qty	UOM	0B1126A0	DOOR LOWER FRAME SHAPE 860 MM	1	PZ	RC1200A0	ED=4 WIRE D.=0.5 COMPRESSIO N SPRING	2	PZ	VI1220A1	4,2X12 TCB SELF-TAPPIN G SCREW	1	PZ	VI1996A0	M5X35 SCREW	7	PZ	VM1794A0	250X4.8 PA66 BLACK CLAMP	2	PZ	VM2103A0	CLAMP LOCK	2	PZ	VM2259A1	6 SERIES DOOR LOWER LEFT CAP	1	PZ	VM2261A1	6 SERIES DOOR LOWER RIGHT CAP	1	PZ	VM2267A0	INTERNAL GLASS LOCKING SYSTEM SLIDER	1	PZ	VM2269A0	INTERNAL GLASS LOCKING SYSTEM CAP	1	PZ	VM2274A0	GROOVED BUSHING	1	PZ	VM2305A0	6 SERIES DOOR CAP FIXING PAWL	7	PZ
Code	Description	Qty	UOM																																																						
0B1126A0	DOOR LOWER FRAME SHAPE 860 MM	1	PZ																																																						
RC1200A0	ED=4 WIRE D.=0.5 COMPRESSIO N SPRING	2	PZ																																																						
VI1220A1	4,2X12 TCB SELF-TAPPIN G SCREW	1	PZ																																																						
VI1996A0	M5X35 SCREW	7	PZ																																																						
VM1794A0	250X4.8 PA66 BLACK CLAMP	2	PZ																																																						
VM2103A0	CLAMP LOCK	2	PZ																																																						
VM2259A1	6 SERIES DOOR LOWER LEFT CAP	1	PZ																																																						
VM2261A1	6 SERIES DOOR LOWER RIGHT CAP	1	PZ																																																						
VM2267A0	INTERNAL GLASS LOCKING SYSTEM SLIDER	1	PZ																																																						
VM2269A0	INTERNAL GLASS LOCKING SYSTEM CAP	1	PZ																																																						
VM2274A0	GROOVED BUSHING	1	PZ																																																						
VM2305A0	6 SERIES DOOR CAP FIXING PAWL	7	PZ																																																						
			K0B1126AL	BAKERTOP LEFT DOOR LOWER BEAM KIT	<table border="1"> <thead> <tr> <th>Code</th> <th>Description</th> <th>Qty</th> <th>UOM</th> </tr> </thead> <tbody> <tr> <td>0B1126A0</td> <td>DOOR LOWER FRAME SHAPE 860 MM</td> <td>1</td> <td>PZ</td> </tr> <tr> <td>RC1200A0</td> <td>ED=4 WIRE D.=0.5 COMPRESSIO N SPRING</td> <td>2</td> <td>PZ</td> </tr> <tr> <td>VI1220A1</td> <td>4,2X12 TCB SELF-TAPPIN G SCREW</td> <td>1</td> <td>PZ</td> </tr> <tr> <td>VI1996A0</td> <td>M5X35 SCREW</td> <td>7</td> <td>PZ</td> </tr> <tr> <td>VM1794A0</td> <td>250X4.8 PA66 BLACK CLAMP</td> <td>2</td> <td>PZ</td> </tr> <tr> <td>VM2103A0</td> <td>CLAMP LOCK</td> <td>2</td> <td>PZ</td> </tr> </tbody> </table>	Code	Description	Qty	UOM	0B1126A0	DOOR LOWER FRAME SHAPE 860 MM	1	PZ	RC1200A0	ED=4 WIRE D.=0.5 COMPRESSIO N SPRING	2	PZ	VI1220A1	4,2X12 TCB SELF-TAPPIN G SCREW	1	PZ	VI1996A0	M5X35 SCREW	7	PZ	VM1794A0	250X4.8 PA66 BLACK CLAMP	2	PZ	VM2103A0	CLAMP LOCK	2	PZ																								
Code	Description	Qty	UOM																																																						
0B1126A0	DOOR LOWER FRAME SHAPE 860 MM	1	PZ																																																						
RC1200A0	ED=4 WIRE D.=0.5 COMPRESSIO N SPRING	2	PZ																																																						
VI1220A1	4,2X12 TCB SELF-TAPPIN G SCREW	1	PZ																																																						
VI1996A0	M5X35 SCREW	7	PZ																																																						
VM1794A0	250X4.8 PA66 BLACK CLAMP	2	PZ																																																						
VM2103A0	CLAMP LOCK	2	PZ																																																						

COMPONENT			SPARE PART																																																			
Code	Description	Image	Code	Description	Components list																																																	
VM2274A	GROOVED BUSHING		K0B1126AL	BAKERTOP LEFT DOOR LOWER BEAM KIT	<table border="1"> <thead> <tr> <th>Code</th> <th>Description</th> <th>Qty</th> <th>UOM</th> </tr> </thead> <tbody> <tr> <td>VM2267A0</td> <td>INTERNAL GLASS LOCKING SYSTEM SLIDER</td> <td>1</td> <td>PZ</td> </tr> <tr> <td>VM2269A0</td> <td>INTERNAL GLASS LOCKING SYSTEM CAP</td> <td>1</td> <td>PZ</td> </tr> <tr> <td>VM2274A0</td> <td>GROOVED BUSHING</td> <td>1</td> <td>PZ</td> </tr> <tr> <td>VM2305A0</td> <td>6 SERIES DOOR CAP FIXING PAWL</td> <td>7</td> <td>PZ</td> </tr> <tr> <td>VM2384A0</td> <td>LEFT MM DOOR LOWER RIGHT CAP</td> <td>1</td> <td>PZ</td> </tr> <tr> <td>VM2386A1</td> <td>LEFT MM DOOR LOWER LEFT CAP</td> <td>1</td> <td>PZ</td> </tr> </tbody> </table>	Code	Description	Qty	UOM	VM2267A0	INTERNAL GLASS LOCKING SYSTEM SLIDER	1	PZ	VM2269A0	INTERNAL GLASS LOCKING SYSTEM CAP	1	PZ	VM2274A0	GROOVED BUSHING	1	PZ	VM2305A0	6 SERIES DOOR CAP FIXING PAWL	7	PZ	VM2384A0	LEFT MM DOOR LOWER RIGHT CAP	1	PZ	VM2386A1	LEFT MM DOOR LOWER LEFT CAP	1	PZ																					
			Code	Description	Qty	UOM																																																
VM2267A0	INTERNAL GLASS LOCKING SYSTEM SLIDER	1	PZ																																																			
VM2269A0	INTERNAL GLASS LOCKING SYSTEM CAP	1	PZ																																																			
VM2274A0	GROOVED BUSHING	1	PZ																																																			
VM2305A0	6 SERIES DOOR CAP FIXING PAWL	7	PZ																																																			
VM2384A0	LEFT MM DOOR LOWER RIGHT CAP	1	PZ																																																			
VM2386A1	LEFT MM DOOR LOWER LEFT CAP	1	PZ																																																			
K0B1122AR	CHEFTOP RIGHT DOOR LOWER BEAM KIT	<table border="1"> <thead> <tr> <th>Code</th> <th>Description</th> <th>Qty</th> <th>UOM</th> </tr> </thead> <tbody> <tr> <td>0B1122A0</td> <td>6 SERIES DOOR LOWER FRAME SHAPE</td> <td>1</td> <td>PZ</td> </tr> <tr> <td>RC1200A0</td> <td>ED=4 WIRE D.=0.5 COMPRESSIO N SPRING</td> <td>2</td> <td>PZ</td> </tr> <tr> <td>V11220A1</td> <td>4,2X12 TCB SELF-TAPPIN G SCREW</td> <td>1</td> <td>PZ</td> </tr> <tr> <td>V11996A0</td> <td>M5X35 SCREW</td> <td>7</td> <td>PZ</td> </tr> <tr> <td>VM1794A0</td> <td>250X4.8 PA66 BLACK CLAMP</td> <td>2</td> <td>PZ</td> </tr> <tr> <td>VM2103A0</td> <td>CLAMP LOCK</td> <td>2</td> <td>PZ</td> </tr> <tr> <td>VM2259A1</td> <td>6 SERIES DOOR LOWER LEFT CAP</td> <td>1</td> <td>PZ</td> </tr> <tr> <td>VM2261A1</td> <td>6 SERIES DOOR LOWER RIGHT CAP</td> <td>1</td> <td>PZ</td> </tr> <tr> <td>VM2267A0</td> <td>INTERNAL GLASS LOCKING SYSTEM SLIDER</td> <td>1</td> <td>PZ</td> </tr> <tr> <td>VM2269A0</td> <td>INTERNAL GLASS LOCKING SYSTEM CAP</td> <td>1</td> <td>PZ</td> </tr> <tr> <td>VM2274A0</td> <td>GROOVED BUSHING</td> <td>1</td> <td>PZ</td> </tr> <tr> <td>VM2305A0</td> <td>6 SERIES DOOR CAP FIXING PAWL</td> <td>7</td> <td>PZ</td> </tr> </tbody> </table>	Code	Description	Qty	UOM	0B1122A0	6 SERIES DOOR LOWER FRAME SHAPE	1	PZ	RC1200A0	ED=4 WIRE D.=0.5 COMPRESSIO N SPRING	2	PZ	V11220A1	4,2X12 TCB SELF-TAPPIN G SCREW	1	PZ	V11996A0	M5X35 SCREW	7	PZ	VM1794A0	250X4.8 PA66 BLACK CLAMP	2	PZ	VM2103A0	CLAMP LOCK	2	PZ	VM2259A1	6 SERIES DOOR LOWER LEFT CAP	1	PZ	VM2261A1	6 SERIES DOOR LOWER RIGHT CAP	1	PZ	VM2267A0	INTERNAL GLASS LOCKING SYSTEM SLIDER	1	PZ	VM2269A0	INTERNAL GLASS LOCKING SYSTEM CAP	1	PZ	VM2274A0	GROOVED BUSHING	1	PZ	VM2305A0	6 SERIES DOOR CAP FIXING PAWL	7	PZ
Code	Description	Qty	UOM																																																			
0B1122A0	6 SERIES DOOR LOWER FRAME SHAPE	1	PZ																																																			
RC1200A0	ED=4 WIRE D.=0.5 COMPRESSIO N SPRING	2	PZ																																																			
V11220A1	4,2X12 TCB SELF-TAPPIN G SCREW	1	PZ																																																			
V11996A0	M5X35 SCREW	7	PZ																																																			
VM1794A0	250X4.8 PA66 BLACK CLAMP	2	PZ																																																			
VM2103A0	CLAMP LOCK	2	PZ																																																			
VM2259A1	6 SERIES DOOR LOWER LEFT CAP	1	PZ																																																			
VM2261A1	6 SERIES DOOR LOWER RIGHT CAP	1	PZ																																																			
VM2267A0	INTERNAL GLASS LOCKING SYSTEM SLIDER	1	PZ																																																			
VM2269A0	INTERNAL GLASS LOCKING SYSTEM CAP	1	PZ																																																			
VM2274A0	GROOVED BUSHING	1	PZ																																																			
VM2305A0	6 SERIES DOOR CAP FIXING PAWL	7	PZ																																																			



COMPONENT			SPARE PART																																																						
Code	Description	Image	Code	Description	Components list																																																				
VM2274A	GROOVED BUSHING		K0B1122AL	CHEFTOP MM LEFT DOOR LOWER BEAM KIT	<table border="1"> <thead> <tr> <th>Code</th> <th>Description</th> <th>Qty</th> <th>UOM</th> </tr> </thead> <tbody> <tr> <td>0B1122A0</td> <td>6 SERIES DOOR LOWER FRAME SHAPE</td> <td>1</td> <td>PZ</td> </tr> <tr> <td>RC1200A0</td> <td>ED=4 WIRE D.=0.5 COMPRESSIO N SPRING</td> <td>2</td> <td>PZ</td> </tr> <tr> <td>V11220A1</td> <td>4,2X12 TCB SELF-TAPPIN G SCREW</td> <td>1</td> <td>PZ</td> </tr> <tr> <td>VI1996A0</td> <td>M5X35 SCREW</td> <td>7</td> <td>PZ</td> </tr> <tr> <td>VM1794A0</td> <td>250X4.8 PA66 BLACK CLAMP</td> <td>2</td> <td>PZ</td> </tr> <tr> <td>VM2103A0</td> <td>CLAMP LOCK</td> <td>2</td> <td>PZ</td> </tr> <tr> <td>VM2267A0</td> <td>INTERNAL GLASS LOCKING SYSTEM SLIDER</td> <td>1</td> <td>PZ</td> </tr> <tr> <td>VM2269A0</td> <td>INTERNAL GLASS LOCKING SYSTEM CAP</td> <td>1</td> <td>PZ</td> </tr> <tr> <td>VM2274A0</td> <td>GROOVED BUSHING</td> <td>1</td> <td>PZ</td> </tr> <tr> <td>VM2305A0</td> <td>6 SERIES DOOR CAP FIXING PAWL</td> <td>7</td> <td>PZ</td> </tr> <tr> <td>VM2384A0</td> <td>LEFT MM DOOR LOWER RIGHT CAP</td> <td>1</td> <td>PZ</td> </tr> <tr> <td>VM2386A1</td> <td>LEFT MM DOOR LOWER LEFT CAP</td> <td>1</td> <td>PZ</td> </tr> </tbody> </table>	Code	Description	Qty	UOM	0B1122A0	6 SERIES DOOR LOWER FRAME SHAPE	1	PZ	RC1200A0	ED=4 WIRE D.=0.5 COMPRESSIO N SPRING	2	PZ	V11220A1	4,2X12 TCB SELF-TAPPIN G SCREW	1	PZ	VI1996A0	M5X35 SCREW	7	PZ	VM1794A0	250X4.8 PA66 BLACK CLAMP	2	PZ	VM2103A0	CLAMP LOCK	2	PZ	VM2267A0	INTERNAL GLASS LOCKING SYSTEM SLIDER	1	PZ	VM2269A0	INTERNAL GLASS LOCKING SYSTEM CAP	1	PZ	VM2274A0	GROOVED BUSHING	1	PZ	VM2305A0	6 SERIES DOOR CAP FIXING PAWL	7	PZ	VM2384A0	LEFT MM DOOR LOWER RIGHT CAP	1	PZ	VM2386A1	LEFT MM DOOR LOWER LEFT CAP	1	PZ
Code	Description	Qty	UOM																																																						
0B1122A0	6 SERIES DOOR LOWER FRAME SHAPE	1	PZ																																																						
RC1200A0	ED=4 WIRE D.=0.5 COMPRESSIO N SPRING	2	PZ																																																						
V11220A1	4,2X12 TCB SELF-TAPPIN G SCREW	1	PZ																																																						
VI1996A0	M5X35 SCREW	7	PZ																																																						
VM1794A0	250X4.8 PA66 BLACK CLAMP	2	PZ																																																						
VM2103A0	CLAMP LOCK	2	PZ																																																						
VM2267A0	INTERNAL GLASS LOCKING SYSTEM SLIDER	1	PZ																																																						
VM2269A0	INTERNAL GLASS LOCKING SYSTEM CAP	1	PZ																																																						
VM2274A0	GROOVED BUSHING	1	PZ																																																						
VM2305A0	6 SERIES DOOR CAP FIXING PAWL	7	PZ																																																						
VM2384A0	LEFT MM DOOR LOWER RIGHT CAP	1	PZ																																																						
VM2386A1	LEFT MM DOOR LOWER LEFT CAP	1	PZ																																																						
VM2305A	6 SERIES DOOR CAP FIXING PAWL		VM2305A0	6 SERIES DOOR CAP FIXING PAWL																																																					
VI1996A	M5X35 SCREW		VI1996A0	M5X35 SCREW																																																					



COMPONENT			SPARE PART																																																																						
Code	Description	Image	Code	Description	Components list																																																																				
VM2259A	6 SERIES DOOR LOWER LEFT CAP		KVM2259A	MIND MAPS DOOR LEFT LOWER CAP KI	<table border="1"> <thead> <tr> <th>Code</th> <th>Description</th> <th>Qty</th> <th>UOM</th> </tr> </thead> <tbody> <tr> <td>V11996A0</td> <td>M5X35 SCREW</td> <td>3</td> <td>PZ</td> </tr> <tr> <td>VM2259A1</td> <td>6 SERIES DOOR LOWER LEFT CAP</td> <td>1</td> <td>PZ</td> </tr> <tr> <td>VM2305A0</td> <td>6 SERIES DOOR CAP FIXING PAWL</td> <td>3</td> <td>PZ</td> </tr> </tbody> </table>	Code	Description	Qty	UOM	V11996A0	M5X35 SCREW	3	PZ	VM2259A1	6 SERIES DOOR LOWER LEFT CAP	1	PZ	VM2305A0	6 SERIES DOOR CAP FIXING PAWL	3	PZ																																																				
			Code	Description	Qty	UOM																																																																			
V11996A0	M5X35 SCREW	3	PZ																																																																						
VM2259A1	6 SERIES DOOR LOWER LEFT CAP	1	PZ																																																																						
VM2305A0	6 SERIES DOOR CAP FIXING PAWL	3	PZ																																																																						
K0B1126AR	BAKERTOP RIGHT DOOR LOWER BEAM KIT	<table border="1"> <thead> <tr> <th>Code</th> <th>Description</th> <th>Qty</th> <th>UOM</th> </tr> </thead> <tbody> <tr> <td>0B1126A0</td> <td>DOOR LOWER FRAME SHAPE 860 MM</td> <td>1</td> <td>PZ</td> </tr> <tr> <td>RC1200A0</td> <td>ED=4 WIRE D.=0.5 COMPRESSIO N SPRING</td> <td>2</td> <td>PZ</td> </tr> <tr> <td>V11220A1</td> <td>4,2X12 TCB SELF-TAPPIN G SCREW</td> <td>1</td> <td>PZ</td> </tr> <tr> <td>V11996A0</td> <td>M5X35 SCREW</td> <td>7</td> <td>PZ</td> </tr> <tr> <td>VM1794A0</td> <td>250X4.8 PA66 BLACK CLAMP</td> <td>2</td> <td>PZ</td> </tr> <tr> <td>VM2103A0</td> <td>CLAMP LOCK</td> <td>2</td> <td>PZ</td> </tr> <tr> <td>VM2259A1</td> <td>6 SERIES DOOR LOWER LEFT CAP</td> <td>1</td> <td>PZ</td> </tr> <tr> <td>VM2261A1</td> <td>6 SERIES DOOR LOWER RIGHT CAP</td> <td>1</td> <td>PZ</td> </tr> <tr> <td>VM2267A0</td> <td>INTERNAL GLASS LOCKING SYSTEM SLIDER</td> <td>1</td> <td>PZ</td> </tr> <tr> <td>VM2269A0</td> <td>INTERNAL GLASS LOCKING SYSTEM CAP</td> <td>1</td> <td>PZ</td> </tr> <tr> <td>VM2274A0</td> <td>GROOVED BUSHING</td> <td>1</td> <td>PZ</td> </tr> <tr> <td>VM2305A0</td> <td>6 SERIES DOOR CAP FIXING PAWL</td> <td>7</td> <td>PZ</td> </tr> </tbody> </table>	Code	Description	Qty	UOM	0B1126A0	DOOR LOWER FRAME SHAPE 860 MM	1	PZ	RC1200A0	ED=4 WIRE D.=0.5 COMPRESSIO N SPRING	2	PZ	V11220A1	4,2X12 TCB SELF-TAPPIN G SCREW	1	PZ	V11996A0	M5X35 SCREW	7	PZ	VM1794A0	250X4.8 PA66 BLACK CLAMP	2	PZ	VM2103A0	CLAMP LOCK	2	PZ	VM2259A1	6 SERIES DOOR LOWER LEFT CAP	1	PZ	VM2261A1	6 SERIES DOOR LOWER RIGHT CAP	1	PZ	VM2267A0	INTERNAL GLASS LOCKING SYSTEM SLIDER	1	PZ	VM2269A0	INTERNAL GLASS LOCKING SYSTEM CAP	1	PZ	VM2274A0	GROOVED BUSHING	1	PZ	VM2305A0	6 SERIES DOOR CAP FIXING PAWL	7	PZ	K0B1126AL	BAKERTOP LEFT DOOR LOWER BEAM KIT	<table border="1"> <thead> <tr> <th>Code</th> <th>Description</th> <th>Qty</th> <th>UOM</th> </tr> </thead> <tbody> <tr> <td>0B1126A0</td> <td>DOOR LOWER FRAME SHAPE 860 MM</td> <td>1</td> <td>PZ</td> </tr> <tr> <td>RC1200A0</td> <td>ED=4 WIRE D.=0.5 COMPRESSIO N SPRING</td> <td>2</td> <td>PZ</td> </tr> <tr> <td>V11220A1</td> <td>4,2X12 TCB SELF-TAPPIN G SCREW</td> <td>1</td> <td>PZ</td> </tr> </tbody> </table>	Code	Description	Qty	UOM	0B1126A0	DOOR LOWER FRAME SHAPE 860 MM	1	PZ	RC1200A0	ED=4 WIRE D.=0.5 COMPRESSIO N SPRING	2	PZ	V11220A1	4,2X12 TCB SELF-TAPPIN G SCREW	1	PZ
Code	Description	Qty	UOM																																																																						
0B1126A0	DOOR LOWER FRAME SHAPE 860 MM	1	PZ																																																																						
RC1200A0	ED=4 WIRE D.=0.5 COMPRESSIO N SPRING	2	PZ																																																																						
V11220A1	4,2X12 TCB SELF-TAPPIN G SCREW	1	PZ																																																																						
V11996A0	M5X35 SCREW	7	PZ																																																																						
VM1794A0	250X4.8 PA66 BLACK CLAMP	2	PZ																																																																						
VM2103A0	CLAMP LOCK	2	PZ																																																																						
VM2259A1	6 SERIES DOOR LOWER LEFT CAP	1	PZ																																																																						
VM2261A1	6 SERIES DOOR LOWER RIGHT CAP	1	PZ																																																																						
VM2267A0	INTERNAL GLASS LOCKING SYSTEM SLIDER	1	PZ																																																																						
VM2269A0	INTERNAL GLASS LOCKING SYSTEM CAP	1	PZ																																																																						
VM2274A0	GROOVED BUSHING	1	PZ																																																																						
VM2305A0	6 SERIES DOOR CAP FIXING PAWL	7	PZ																																																																						
Code	Description	Qty	UOM																																																																						
0B1126A0	DOOR LOWER FRAME SHAPE 860 MM	1	PZ																																																																						
RC1200A0	ED=4 WIRE D.=0.5 COMPRESSIO N SPRING	2	PZ																																																																						
V11220A1	4,2X12 TCB SELF-TAPPIN G SCREW	1	PZ																																																																						





COMPONENT			SPARE PART																																											
Code	Description	Image	Code	Description	Components list																																									
VM2259A	6 SERIES DOOR LOWER LEFT CAP		K0B1126AL	BAKERTOP LEFT DOOR LOWER BEAM KIT	<table border="1"> <thead> <tr> <th>Code</th> <th>Description</th> <th>Qty</th> <th>UOM</th> </tr> </thead> <tbody> <tr> <td>VI1996A0</td> <td>M5X35 SCREW</td> <td>7</td> <td>PZ</td> </tr> <tr> <td>VM1794A0</td> <td>250X4.8 PA66 BLACK CLAMP</td> <td>2</td> <td>PZ</td> </tr> <tr> <td>VM2103A0</td> <td>CLAMP LOCK</td> <td>2</td> <td>PZ</td> </tr> <tr> <td>VM2267A0</td> <td>INTERNAL GLASS LOCKING SYSTEM SLIDER</td> <td>1</td> <td>PZ</td> </tr> <tr> <td>VM2269A0</td> <td>INTERNAL GLASS LOCKING SYSTEM CAP</td> <td>1</td> <td>PZ</td> </tr> <tr> <td>VM2274A0</td> <td>GROOVED BUSHING</td> <td>1</td> <td>PZ</td> </tr> <tr> <td>VM2305A0</td> <td>6 SERIES DOOR CAP FIXING PAWL</td> <td>7</td> <td>PZ</td> </tr> <tr> <td>VM2384A0</td> <td>LEFT MM DOOR LOWER RIGHT CAP</td> <td>1</td> <td>PZ</td> </tr> <tr> <td>VM2386A1</td> <td>LEFT MM DOOR LOWER LEFT CAP</td> <td>1</td> <td>PZ</td> </tr> </tbody> </table>	Code	Description	Qty	UOM	VI1996A0	M5X35 SCREW	7	PZ	VM1794A0	250X4.8 PA66 BLACK CLAMP	2	PZ	VM2103A0	CLAMP LOCK	2	PZ	VM2267A0	INTERNAL GLASS LOCKING SYSTEM SLIDER	1	PZ	VM2269A0	INTERNAL GLASS LOCKING SYSTEM CAP	1	PZ	VM2274A0	GROOVED BUSHING	1	PZ	VM2305A0	6 SERIES DOOR CAP FIXING PAWL	7	PZ	VM2384A0	LEFT MM DOOR LOWER RIGHT CAP	1	PZ	VM2386A1	LEFT MM DOOR LOWER LEFT CAP	1	PZ	
			Code	Description	Qty	UOM																																								
VI1996A0	M5X35 SCREW	7	PZ																																											
VM1794A0	250X4.8 PA66 BLACK CLAMP	2	PZ																																											
VM2103A0	CLAMP LOCK	2	PZ																																											
VM2267A0	INTERNAL GLASS LOCKING SYSTEM SLIDER	1	PZ																																											
VM2269A0	INTERNAL GLASS LOCKING SYSTEM CAP	1	PZ																																											
VM2274A0	GROOVED BUSHING	1	PZ																																											
VM2305A0	6 SERIES DOOR CAP FIXING PAWL	7	PZ																																											
VM2384A0	LEFT MM DOOR LOWER RIGHT CAP	1	PZ																																											
VM2386A1	LEFT MM DOOR LOWER LEFT CAP	1	PZ																																											
K0B1122AR	CHEFTOP RIGHT DOOR LOWER BEAM KIT	<table border="1"> <thead> <tr> <th>Code</th> <th>Description</th> <th>Qty</th> <th>UOM</th> </tr> </thead> <tbody> <tr> <td>0B1122A0</td> <td>6 SERIES DOOR LOWER FRAME SHAPE</td> <td>1</td> <td>PZ</td> </tr> <tr> <td>RC1200A0</td> <td>ED=4 WIRE D.=0.5 COMPRESSION N SPRING</td> <td>2</td> <td>PZ</td> </tr> <tr> <td>VI1220A1</td> <td>4,2X12 TCB SELF-TAPPIN G SCREW</td> <td>1</td> <td>PZ</td> </tr> <tr> <td>VI1996A0</td> <td>M5X35 SCREW</td> <td>7</td> <td>PZ</td> </tr> <tr> <td>VM1794A0</td> <td>250X4.8 PA66 BLACK CLAMP</td> <td>2</td> <td>PZ</td> </tr> <tr> <td>VM2103A0</td> <td>CLAMP LOCK</td> <td>2</td> <td>PZ</td> </tr> <tr> <td>VM2259A1</td> <td>6 SERIES DOOR LOWER LEFT CAP</td> <td>1</td> <td>PZ</td> </tr> <tr> <td>VM2261A1</td> <td>6 SERIES DOOR LOWER RIGHT CAP</td> <td>1</td> <td>PZ</td> </tr> <tr> <td>VM2267A0</td> <td>INTERNAL GLASS LOCKING SYSTEM SLIDER</td> <td>1</td> <td>PZ</td> </tr> <tr> <td>VM2269A0</td> <td>INTERNAL GLASS LOCKING SYSTEM CAP</td> <td>1</td> <td>PZ</td> </tr> </tbody> </table>	Code	Description	Qty	UOM	0B1122A0	6 SERIES DOOR LOWER FRAME SHAPE	1	PZ	RC1200A0	ED=4 WIRE D.=0.5 COMPRESSION N SPRING	2	PZ	VI1220A1	4,2X12 TCB SELF-TAPPIN G SCREW	1	PZ	VI1996A0	M5X35 SCREW	7	PZ	VM1794A0	250X4.8 PA66 BLACK CLAMP	2	PZ	VM2103A0	CLAMP LOCK	2	PZ	VM2259A1	6 SERIES DOOR LOWER LEFT CAP	1	PZ	VM2261A1	6 SERIES DOOR LOWER RIGHT CAP	1	PZ	VM2267A0	INTERNAL GLASS LOCKING SYSTEM SLIDER	1	PZ	VM2269A0	INTERNAL GLASS LOCKING SYSTEM CAP	1	PZ
Code	Description	Qty	UOM																																											
0B1122A0	6 SERIES DOOR LOWER FRAME SHAPE	1	PZ																																											
RC1200A0	ED=4 WIRE D.=0.5 COMPRESSION N SPRING	2	PZ																																											
VI1220A1	4,2X12 TCB SELF-TAPPIN G SCREW	1	PZ																																											
VI1996A0	M5X35 SCREW	7	PZ																																											
VM1794A0	250X4.8 PA66 BLACK CLAMP	2	PZ																																											
VM2103A0	CLAMP LOCK	2	PZ																																											
VM2259A1	6 SERIES DOOR LOWER LEFT CAP	1	PZ																																											
VM2261A1	6 SERIES DOOR LOWER RIGHT CAP	1	PZ																																											
VM2267A0	INTERNAL GLASS LOCKING SYSTEM SLIDER	1	PZ																																											
VM2269A0	INTERNAL GLASS LOCKING SYSTEM CAP	1	PZ																																											

COMPONENT			SPARE PART																																																			
Code	Description	Image	Code	Description	Components list																																																	
VM2259A	6 SERIES DOOR LOWER LEFT CAP		K0B1122AR	CHEFTOP RIGHT DOOR LOWER BEAM KIT	<table border="1"> <thead> <tr> <th>Code</th> <th>Description</th> <th>Qty</th> <th>UOM</th> </tr> </thead> <tbody> <tr> <td>VM2274A0</td> <td>GROOVED BUSHING</td> <td>1</td> <td>PZ</td> </tr> <tr> <td>VM2305A0</td> <td>6 SERIES DOOR CAP FIXING PAWL</td> <td>7</td> <td>PZ</td> </tr> </tbody> </table>	Code	Description	Qty	UOM	VM2274A0	GROOVED BUSHING	1	PZ	VM2305A0	6 SERIES DOOR CAP FIXING PAWL	7	PZ																																					
			Code	Description	Qty	UOM																																																
VM2274A0	GROOVED BUSHING	1	PZ																																																			
VM2305A0	6 SERIES DOOR CAP FIXING PAWL	7	PZ																																																			
K0B1122AL	CHEFTOP MM LEFT DOOR LOWER BEAM KIT	<table border="1"> <thead> <tr> <th>Code</th> <th>Description</th> <th>Qty</th> <th>UOM</th> </tr> </thead> <tbody> <tr> <td>0B1122A0</td> <td>6 SERIES DOOR LOWER FRAME SHAPE</td> <td>1</td> <td>PZ</td> </tr> <tr> <td>RC1200A0</td> <td>ED=4 WIRE D.=0.5 COMPRESSION N SPRING</td> <td>2</td> <td>PZ</td> </tr> <tr> <td>VI1220A1</td> <td>4,2X12 TCB SELF-TAPPIN G SCREW</td> <td>1</td> <td>PZ</td> </tr> <tr> <td>VI1996A0</td> <td>MSX35 SCREW</td> <td>7</td> <td>PZ</td> </tr> <tr> <td>VM1794A0</td> <td>250X4.8 PA66 BLACK CLAMP</td> <td>2</td> <td>PZ</td> </tr> <tr> <td>VM2103A0</td> <td>CLAMP LOCK</td> <td>2</td> <td>PZ</td> </tr> <tr> <td>VM2267A0</td> <td>INTERNAL GLASS LOCKING SYSTEM SLIDER</td> <td>1</td> <td>PZ</td> </tr> <tr> <td>VM2269A0</td> <td>INTERNAL GLASS LOCKING SYSTEM CAP</td> <td>1</td> <td>PZ</td> </tr> <tr> <td>VM2274A0</td> <td>GROOVED BUSHING</td> <td>1</td> <td>PZ</td> </tr> <tr> <td>VM2305A0</td> <td>6 SERIES DOOR CAP FIXING PAWL</td> <td>7</td> <td>PZ</td> </tr> <tr> <td>VM2384A0</td> <td>LEFT MM DOOR LOWER RIGHT CAP</td> <td>1</td> <td>PZ</td> </tr> <tr> <td>VM2386A1</td> <td>LEFT MM DOOR LOWER LEFT CAP</td> <td>1</td> <td>PZ</td> </tr> </tbody> </table>	Code	Description	Qty	UOM	0B1122A0	6 SERIES DOOR LOWER FRAME SHAPE	1	PZ	RC1200A0	ED=4 WIRE D.=0.5 COMPRESSION N SPRING	2	PZ	VI1220A1	4,2X12 TCB SELF-TAPPIN G SCREW	1	PZ	VI1996A0	MSX35 SCREW	7	PZ	VM1794A0	250X4.8 PA66 BLACK CLAMP	2	PZ	VM2103A0	CLAMP LOCK	2	PZ	VM2267A0	INTERNAL GLASS LOCKING SYSTEM SLIDER	1	PZ	VM2269A0	INTERNAL GLASS LOCKING SYSTEM CAP	1	PZ	VM2274A0	GROOVED BUSHING	1	PZ	VM2305A0	6 SERIES DOOR CAP FIXING PAWL	7	PZ	VM2384A0	LEFT MM DOOR LOWER RIGHT CAP	1	PZ	VM2386A1	LEFT MM DOOR LOWER LEFT CAP	1	PZ
Code	Description	Qty	UOM																																																			
0B1122A0	6 SERIES DOOR LOWER FRAME SHAPE	1	PZ																																																			
RC1200A0	ED=4 WIRE D.=0.5 COMPRESSION N SPRING	2	PZ																																																			
VI1220A1	4,2X12 TCB SELF-TAPPIN G SCREW	1	PZ																																																			
VI1996A0	MSX35 SCREW	7	PZ																																																			
VM1794A0	250X4.8 PA66 BLACK CLAMP	2	PZ																																																			
VM2103A0	CLAMP LOCK	2	PZ																																																			
VM2267A0	INTERNAL GLASS LOCKING SYSTEM SLIDER	1	PZ																																																			
VM2269A0	INTERNAL GLASS LOCKING SYSTEM CAP	1	PZ																																																			
VM2274A0	GROOVED BUSHING	1	PZ																																																			
VM2305A0	6 SERIES DOOR CAP FIXING PAWL	7	PZ																																																			
VM2384A0	LEFT MM DOOR LOWER RIGHT CAP	1	PZ																																																			
VM2386A1	LEFT MM DOOR LOWER LEFT CAP	1	PZ																																																			
VM2305A	6 SERIES DOOR CAP FIXING PAWL		VM2305A0	6 SERIES DOOR CAP FIXING PAWL																																																		

COMPONENT			SPARE PART										
Code	Description	Image	Code	Description	Components list								
VM2267A	INTERNAL GLASS LOCKING SYSTEM SLIDER		VM2267A0	INTERNAL GLASS LOCKING SYSTEM SLIDER									
VM2269A	INTERNAL GLASS LOCKING SYSTEM CAP		KVM2269A	INNER GLASS FIXING CAP KIT	<table border="1"> <thead> <tr> <th>Code</th> <th>Description</th> <th>Qty</th> <th>UOM</th> </tr> </thead> <tbody> <tr> <td>VM2269A0</td> <td>INTERNAL GLASS LOCKING SYSTEM CAP</td> <td>2</td> <td>PZ</td> </tr> </tbody> </table>	Code	Description	Qty	UOM	VM2269A0	INTERNAL GLASS LOCKING SYSTEM CAP	2	PZ
Code	Description	Qty	UOM										
VM2269A0	INTERNAL GLASS LOCKING SYSTEM CAP	2	PZ										
VE1030A	MAGNET FOR DOOR MICROSWITCH D=22,9MM		KVE1030A	2 PCS MAGNET KIT FOR DOOR SWITCH	<table border="1"> <thead> <tr> <th>Code</th> <th>Description</th> <th>Qty</th> <th>UOM</th> </tr> </thead> <tbody> <tr> <td>VE1030A1</td> <td>MAGNET FOR DOOR MICROSWITCH H D=22,9MM</td> <td>2</td> <td>PZ</td> </tr> </tbody> </table>	Code	Description	Qty	UOM	VE1030A1	MAGNET FOR DOOR MICROSWITCH H D=22,9MM	2	PZ
Code	Description	Qty	UOM										
VE1030A1	MAGNET FOR DOOR MICROSWITCH H D=22,9MM	2	PZ										
			KVE1020A	MICROSWITCH KIT	<table border="1"> <thead> <tr> <th>Code</th> <th>Description</th> <th>Qty</th> <th>UOM</th> </tr> </thead> <tbody> <tr> <td>VE1020A2</td> <td>MAGNETIC DOOR MICROSWITCH</td> <td>1</td> <td>PZ</td> </tr> </tbody> </table>	Code	Description	Qty	UOM	VE1020A2	MAGNETIC DOOR MICROSWITCH	1	PZ
Code	Description	Qty	UOM										
VE1020A2	MAGNETIC DOOR MICROSWITCH	1	PZ										
			VE1030A1	MAGNET FOR DOOR MICROSWITCH H D=22,9MM	<table border="1"> <thead> <tr> <th>Code</th> <th>Description</th> <th>Qty</th> <th>UOM</th> </tr> </thead> <tbody> <tr> <td>VE1030A1</td> <td>MAGNET FOR DOOR MICROSWITCH H D=22,9MM</td> <td>4</td> <td>PZ</td> </tr> </tbody> </table>	Code	Description	Qty	UOM	VE1030A1	MAGNET FOR DOOR MICROSWITCH H D=22,9MM	4	PZ
Code	Description	Qty	UOM										
VE1030A1	MAGNET FOR DOOR MICROSWITCH H D=22,9MM	4	PZ										
VM2268A	DOOR MAGNET COVER		KVM2268A	DOOR MAGNET COVER KIT	<table border="1"> <thead> <tr> <th>Code</th> <th>Description</th> <th>Qty</th> <th>UOM</th> </tr> </thead> <tbody> <tr> <td>VM2268A0</td> <td>DOOR MAGNET COVER</td> <td>1</td> <td>PZ</td> </tr> </tbody> </table>	Code	Description	Qty	UOM	VM2268A0	DOOR MAGNET COVER	1	PZ
Code	Description	Qty	UOM										
VM2268A0	DOOR MAGNET COVER	1	PZ										
VI1996A	M5X35 SCREW		VI1996A0	M5X35 SCREW									

COMPONENT			SPARE PART										
Code	Description	Image	Code	Description	Components list								
VM2262A	6 SERIES DOOR UPPER RIGHT CAP		KVM2262A	MIND.MAPS DOOR RIGHT UPPER CAP KIT	<table border="1"> <thead> <tr> <th>Code</th> <th>Description</th> <th>Qty</th> <th>UOM</th> </tr> </thead> <tbody> <tr> <td>VM2262A1</td> <td>6 SERIES DOOR UPPER RIGHT CAP</td> <td>1</td> <td>PZ</td> </tr> </tbody> </table>	Code	Description	Qty	UOM	VM2262A1	6 SERIES DOOR UPPER RIGHT CAP	1	PZ
Code	Description	Qty	UOM										
VM2262A1	6 SERIES DOOR UPPER RIGHT CAP	1	PZ										
VM2305A	6 SERIES DOOR CAP FIXING PAWL		VM2305A0	6 SERIES DOOR CAP FIXING PAWL									
VM2267A	INTERNAL GLASS LOCKING SYSTEM SLIDER		VM2267A0	INTERNAL GLASS LOCKING SYSTEM SLIDER									
VM2269A	INTERNAL GLASS LOCKING SYSTEM CAP		KVM2269A	INNER GLASS FIXING CAP KIT	<table border="1"> <thead> <tr> <th>Code</th> <th>Description</th> <th>Qty</th> <th>UOM</th> </tr> </thead> <tbody> <tr> <td>VM2269A0</td> <td>INTERNAL GLASS LOCKING SYSTEM CAP</td> <td>2</td> <td>PZ</td> </tr> </tbody> </table>	Code	Description	Qty	UOM	VM2269A0	INTERNAL GLASS LOCKING SYSTEM CAP	2	PZ
Code	Description	Qty	UOM										
VM2269A0	INTERNAL GLASS LOCKING SYSTEM CAP	2	PZ										
VE1030A	MAGNET FOR DOOR MICROSWITCH D=22,9MM		KVE1030A	2 PCS MAGNET KIT FOR DOOR SWITCH	<table border="1"> <thead> <tr> <th>Code</th> <th>Description</th> <th>Qty</th> <th>UOM</th> </tr> </thead> <tbody> <tr> <td>VE1030A1</td> <td>MAGNET FOR DOOR MICROSWITCH H D=22,9MM</td> <td>2</td> <td>PZ</td> </tr> </tbody> </table>	Code	Description	Qty	UOM	VE1030A1	MAGNET FOR DOOR MICROSWITCH H D=22,9MM	2	PZ
Code	Description	Qty	UOM										
VE1030A1	MAGNET FOR DOOR MICROSWITCH H D=22,9MM	2	PZ										
			KVE1020A	MICROSWITCH KIT	<table border="1"> <thead> <tr> <th>Code</th> <th>Description</th> <th>Qty</th> <th>UOM</th> </tr> </thead> <tbody> <tr> <td>VE1020A2</td> <td>MAGNETIC DOOR MICROSWITCH</td> <td>1</td> <td>PZ</td> </tr> </tbody> </table>	Code	Description	Qty	UOM	VE1020A2	MAGNETIC DOOR MICROSWITCH	1	PZ
Code	Description	Qty	UOM										
VE1020A2	MAGNETIC DOOR MICROSWITCH	1	PZ										
					<table border="1"> <thead> <tr> <th>Code</th> <th>Description</th> <th>Qty</th> <th>UOM</th> </tr> </thead> <tbody> <tr> <td>VE1030A1</td> <td>MAGNET FOR DOOR MICROSWITCH H D=22,9MM</td> <td>4</td> <td>PZ</td> </tr> </tbody> </table>	Code	Description	Qty	UOM	VE1030A1	MAGNET FOR DOOR MICROSWITCH H D=22,9MM	4	PZ
Code	Description	Qty	UOM										
VE1030A1	MAGNET FOR DOOR MICROSWITCH H D=22,9MM	4	PZ										

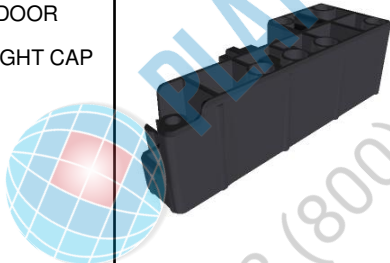
COMPONENT			SPARE PART																																																										
Code	Description	Image	Code	Description	Components list																																																								
VM2268A	DOOR MAGNET COVER		KVM2268A	DOOR MAGNET COVER KIT	<table border="1"> <thead> <tr> <th>Code</th> <th>Description</th> <th>Qty</th> <th>UOM</th> </tr> </thead> <tbody> <tr> <td>VM2268A0</td> <td>DOOR MAGNET COVER</td> <td>1</td> <td>PZ</td> </tr> </tbody> </table>	Code	Description	Qty	UOM	VM2268A0	DOOR MAGNET COVER	1	PZ																																																
Code	Description	Qty	UOM																																																										
VM2268A0	DOOR MAGNET COVER	1	PZ																																																										
VI1996A	M5X35 SCREW		VI1996A0	M5X35 SCREW																																																									
VM2261A	6 SERIES DOOR LOWER RIGHT CAP		KVM2261A  K0B1126AR	MIND.MAPS DOOR RIGHT LOWER CAP KIT  BAKERTOP RIGHT DOOR LOWER BEAM KIT	<table border="1"> <thead> <tr> <th>Code</th> <th>Description</th> <th>Qty</th> <th>UOM</th> </tr> </thead> <tbody> <tr> <td>VI1996A0</td> <td>M5X35 SCREW</td> <td>3</td> <td>PZ</td> </tr> <tr> <td>VM2261A1</td> <td>6 SERIES DOOR LOWER RIGHT CAP</td> <td>1</td> <td>PZ</td> </tr> <tr> <td>VM2305A0</td> <td>6 SERIES DOOR CAP FIXING PAWL</td> <td>3</td> <td>PZ</td> </tr> </tbody> </table> <table border="1"> <thead> <tr> <th>Code</th> <th>Description</th> <th>Qty</th> <th>UOM</th> </tr> </thead> <tbody> <tr> <td>0B1126A0</td> <td>DOOR LOWER FRAME SHAPE 860 MM</td> <td>1</td> <td>PZ</td> </tr> <tr> <td>RC1200A0</td> <td>ED=4 WIRE D.=0.5 COMPRESSIO N SPRING</td> <td>2</td> <td>PZ</td> </tr> <tr> <td>VI1220A1</td> <td>4,2X12 TCB SELF-TAPPIN G SCREW</td> <td>1</td> <td>PZ</td> </tr> <tr> <td>VI1996A0</td> <td>M5X35 SCREW</td> <td>7</td> <td>PZ</td> </tr> <tr> <td>VM1794A0</td> <td>250X4.8 PA66 BLACK CLAMP</td> <td>2</td> <td>PZ</td> </tr> <tr> <td>VM2103A0</td> <td>CLAMP LOCK</td> <td>2</td> <td>PZ</td> </tr> <tr> <td>VM2259A1</td> <td>6 SERIES DOOR LOWER LEFT CAP</td> <td>1</td> <td>PZ</td> </tr> <tr> <td>VM2261A1</td> <td>6 SERIES DOOR LOWER RIGHT CAP</td> <td>1</td> <td>PZ</td> </tr> <tr> <td>VM2267A0</td> <td>INTERNAL GLASS LOCKING SYSTEM SLIDER</td> <td>1</td> <td>PZ</td> </tr> </tbody> </table>	Code	Description	Qty	UOM	VI1996A0	M5X35 SCREW	3	PZ	VM2261A1	6 SERIES DOOR LOWER RIGHT CAP	1	PZ	VM2305A0	6 SERIES DOOR CAP FIXING PAWL	3	PZ	Code	Description	Qty	UOM	0B1126A0	DOOR LOWER FRAME SHAPE 860 MM	1	PZ	RC1200A0	ED=4 WIRE D.=0.5 COMPRESSIO N SPRING	2	PZ	VI1220A1	4,2X12 TCB SELF-TAPPIN G SCREW	1	PZ	VI1996A0	M5X35 SCREW	7	PZ	VM1794A0	250X4.8 PA66 BLACK CLAMP	2	PZ	VM2103A0	CLAMP LOCK	2	PZ	VM2259A1	6 SERIES DOOR LOWER LEFT CAP	1	PZ	VM2261A1	6 SERIES DOOR LOWER RIGHT CAP	1	PZ	VM2267A0	INTERNAL GLASS LOCKING SYSTEM SLIDER	1	PZ
Code	Description	Qty	UOM																																																										
VI1996A0	M5X35 SCREW	3	PZ																																																										
VM2261A1	6 SERIES DOOR LOWER RIGHT CAP	1	PZ																																																										
VM2305A0	6 SERIES DOOR CAP FIXING PAWL	3	PZ																																																										
Code	Description	Qty	UOM																																																										
0B1126A0	DOOR LOWER FRAME SHAPE 860 MM	1	PZ																																																										
RC1200A0	ED=4 WIRE D.=0.5 COMPRESSIO N SPRING	2	PZ																																																										
VI1220A1	4,2X12 TCB SELF-TAPPIN G SCREW	1	PZ																																																										
VI1996A0	M5X35 SCREW	7	PZ																																																										
VM1794A0	250X4.8 PA66 BLACK CLAMP	2	PZ																																																										
VM2103A0	CLAMP LOCK	2	PZ																																																										
VM2259A1	6 SERIES DOOR LOWER LEFT CAP	1	PZ																																																										
VM2261A1	6 SERIES DOOR LOWER RIGHT CAP	1	PZ																																																										
VM2267A0	INTERNAL GLASS LOCKING SYSTEM SLIDER	1	PZ																																																										



COMPONENT			SPARE PART																																																			
Code	Description	Image	Code	Description	Components list																																																	
VM2261A	6 SERIES DOOR LOWER RIGHT CAP		K0B1126AR	BAKERTOP RIGHT DOOR LOWER BEAM KIT	<table border="1"> <thead> <tr> <th>Code</th> <th>Description</th> <th>Qty</th> <th>UOM</th> </tr> </thead> <tbody> <tr> <td>VM2269A0</td> <td>INTERNAL GLASS LOCKING SYSTEM CAP</td> <td>1</td> <td>PZ</td> </tr> <tr> <td>VM2274A0</td> <td>GROOVED BUSHING</td> <td>1</td> <td>PZ</td> </tr> <tr> <td>VM2305A0</td> <td>6 SERIES DOOR CAP FIXING PAWL</td> <td>7</td> <td>PZ</td> </tr> </tbody> </table>	Code	Description	Qty	UOM	VM2269A0	INTERNAL GLASS LOCKING SYSTEM CAP	1	PZ	VM2274A0	GROOVED BUSHING	1	PZ	VM2305A0	6 SERIES DOOR CAP FIXING PAWL	7	PZ																																	
			Code	Description	Qty	UOM																																																
VM2269A0	INTERNAL GLASS LOCKING SYSTEM CAP	1	PZ																																																			
VM2274A0	GROOVED BUSHING	1	PZ																																																			
VM2305A0	6 SERIES DOOR CAP FIXING PAWL	7	PZ																																																			
K0B1126AL	BAKERTOP LEFT DOOR LOWER BEAM KIT	<table border="1"> <thead> <tr> <th>Code</th> <th>Description</th> <th>Qty</th> <th>UOM</th> </tr> </thead> <tbody> <tr> <td>0B1126A0</td> <td>DOOR LOWER FRAME SHAPE 860 MM</td> <td>1</td> <td>PZ</td> </tr> <tr> <td>RC1200A0</td> <td>ED=4 WIRE D.=0.5 COMPRESSIO N SPRING</td> <td>2</td> <td>PZ</td> </tr> <tr> <td>VI1220A1</td> <td>4,2X12 TCB SELF-TAPPIN G SCREW</td> <td>1</td> <td>PZ</td> </tr> <tr> <td>VI1996A0</td> <td>M5X35 SCREW</td> <td>7</td> <td>PZ</td> </tr> <tr> <td>VM1794A0</td> <td>250X4.8 PA66 BLACK CLAMP</td> <td>2</td> <td>PZ</td> </tr> <tr> <td>VM2103A0</td> <td>CLAMP LOCK</td> <td>2</td> <td>PZ</td> </tr> <tr> <td>VM2267A0</td> <td>INTERNAL GLASS LOCKING SYSTEM SLIDER</td> <td>1</td> <td>PZ</td> </tr> <tr> <td>VM2269A0</td> <td>INTERNAL GLASS LOCKING SYSTEM CAP</td> <td>1</td> <td>PZ</td> </tr> <tr> <td>VM2274A0</td> <td>GROOVED BUSHING</td> <td>1</td> <td>PZ</td> </tr> <tr> <td>VM2305A0</td> <td>6 SERIES DOOR CAP FIXING PAWL</td> <td>7</td> <td>PZ</td> </tr> <tr> <td>VM2384A0</td> <td>LEFT MM DOOR LOWER RIGHT CAP</td> <td>1</td> <td>PZ</td> </tr> <tr> <td>VM2386A1</td> <td>LEFT MM DOOR LOWER LEFT CAP</td> <td>1</td> <td>PZ</td> </tr> </tbody> </table>	Code	Description	Qty	UOM	0B1126A0	DOOR LOWER FRAME SHAPE 860 MM	1	PZ	RC1200A0	ED=4 WIRE D.=0.5 COMPRESSIO N SPRING	2	PZ	VI1220A1	4,2X12 TCB SELF-TAPPIN G SCREW	1	PZ	VI1996A0	M5X35 SCREW	7	PZ	VM1794A0	250X4.8 PA66 BLACK CLAMP	2	PZ	VM2103A0	CLAMP LOCK	2	PZ	VM2267A0	INTERNAL GLASS LOCKING SYSTEM SLIDER	1	PZ	VM2269A0	INTERNAL GLASS LOCKING SYSTEM CAP	1	PZ	VM2274A0	GROOVED BUSHING	1	PZ	VM2305A0	6 SERIES DOOR CAP FIXING PAWL	7	PZ	VM2384A0	LEFT MM DOOR LOWER RIGHT CAP	1	PZ	VM2386A1	LEFT MM DOOR LOWER LEFT CAP	1	PZ
Code	Description	Qty	UOM																																																			
0B1126A0	DOOR LOWER FRAME SHAPE 860 MM	1	PZ																																																			
RC1200A0	ED=4 WIRE D.=0.5 COMPRESSIO N SPRING	2	PZ																																																			
VI1220A1	4,2X12 TCB SELF-TAPPIN G SCREW	1	PZ																																																			
VI1996A0	M5X35 SCREW	7	PZ																																																			
VM1794A0	250X4.8 PA66 BLACK CLAMP	2	PZ																																																			
VM2103A0	CLAMP LOCK	2	PZ																																																			
VM2267A0	INTERNAL GLASS LOCKING SYSTEM SLIDER	1	PZ																																																			
VM2269A0	INTERNAL GLASS LOCKING SYSTEM CAP	1	PZ																																																			
VM2274A0	GROOVED BUSHING	1	PZ																																																			
VM2305A0	6 SERIES DOOR CAP FIXING PAWL	7	PZ																																																			
VM2384A0	LEFT MM DOOR LOWER RIGHT CAP	1	PZ																																																			
VM2386A1	LEFT MM DOOR LOWER LEFT CAP	1	PZ																																																			
			K0B1122AR	CHEFTOP RIGHT DOOR LOWER BEAM KIT	<table border="1"> <thead> <tr> <th>Code</th> <th>Description</th> <th>Qty</th> <th>UOM</th> </tr> </thead> <tbody> <tr> <td>0B1122A0</td> <td>6 SERIES DOOR LOWER FRAME SHAPE</td> <td>1</td> <td>PZ</td> </tr> <tr> <td>RC1200A0</td> <td>ED=4 WIRE D.=0.5 COMPRESSIO N SPRING</td> <td>2</td> <td>PZ</td> </tr> </tbody> </table>	Code	Description	Qty	UOM	0B1122A0	6 SERIES DOOR LOWER FRAME SHAPE	1	PZ	RC1200A0	ED=4 WIRE D.=0.5 COMPRESSIO N SPRING	2	PZ																																					
Code	Description	Qty	UOM																																																			
0B1122A0	6 SERIES DOOR LOWER FRAME SHAPE	1	PZ																																																			
RC1200A0	ED=4 WIRE D.=0.5 COMPRESSIO N SPRING	2	PZ																																																			









COMPONENT			SPARE PART																																														
Code	Description	Image	Code	Description	Components list																																												
VM2261A	6 SERIES DOOR LOWER RIGHT CAP		K0B1122AR	CHEFTOP RIGHT DOOR LOWER BEAM KIT	<table border="1"> <thead> <tr> <th>Code</th> <th>Description</th> <th>Qty</th> <th>UOM</th> </tr> </thead> <tbody> <tr> <td>VI1220A1</td> <td>4,2X12 TCB SELF-TAPPIN G SCREW</td> <td>1</td> <td>PZ</td> </tr> <tr> <td>VI1996A0</td> <td>M5X35 SCREW</td> <td>7</td> <td>PZ</td> </tr> <tr> <td>VM1794A0</td> <td>250X4.8 PA66 BLACK CLAMP</td> <td>2</td> <td>PZ</td> </tr> <tr> <td>VM2103A0</td> <td>CLAMP LOCK</td> <td>2</td> <td>PZ</td> </tr> <tr> <td>VM2259A1</td> <td>6 SERIES DOOR LOWER LEFT CAP</td> <td>1</td> <td>PZ</td> </tr> <tr> <td>VM2261A1</td> <td>6 SERIES DOOR LOWER RIGHT CAP</td> <td>1</td> <td>PZ</td> </tr> <tr> <td>VM2267A0</td> <td>INTERNAL GLASS LOCKING SYSTEM SLIDER</td> <td>1</td> <td>PZ</td> </tr> <tr> <td>VM2269A0</td> <td>INTERNAL GLASS LOCKING SYSTEM CAP</td> <td>1</td> <td>PZ</td> </tr> <tr> <td>VM2274A0</td> <td>GROOVED BUSHING</td> <td>1</td> <td>PZ</td> </tr> <tr> <td>VM2305A0</td> <td>6 SERIES DOOR CAP FIXING PAWL</td> <td>7</td> <td>PZ</td> </tr> </tbody> </table>	Code	Description	Qty	UOM	VI1220A1	4,2X12 TCB SELF-TAPPIN G SCREW	1	PZ	VI1996A0	M5X35 SCREW	7	PZ	VM1794A0	250X4.8 PA66 BLACK CLAMP	2	PZ	VM2103A0	CLAMP LOCK	2	PZ	VM2259A1	6 SERIES DOOR LOWER LEFT CAP	1	PZ	VM2261A1	6 SERIES DOOR LOWER RIGHT CAP	1	PZ	VM2267A0	INTERNAL GLASS LOCKING SYSTEM SLIDER	1	PZ	VM2269A0	INTERNAL GLASS LOCKING SYSTEM CAP	1	PZ	VM2274A0	GROOVED BUSHING	1	PZ	VM2305A0	6 SERIES DOOR CAP FIXING PAWL	7	PZ
			Code	Description	Qty	UOM																																											
VI1220A1	4,2X12 TCB SELF-TAPPIN G SCREW	1	PZ																																														
VI1996A0	M5X35 SCREW	7	PZ																																														
VM1794A0	250X4.8 PA66 BLACK CLAMP	2	PZ																																														
VM2103A0	CLAMP LOCK	2	PZ																																														
VM2259A1	6 SERIES DOOR LOWER LEFT CAP	1	PZ																																														
VM2261A1	6 SERIES DOOR LOWER RIGHT CAP	1	PZ																																														
VM2267A0	INTERNAL GLASS LOCKING SYSTEM SLIDER	1	PZ																																														
VM2269A0	INTERNAL GLASS LOCKING SYSTEM CAP	1	PZ																																														
VM2274A0	GROOVED BUSHING	1	PZ																																														
VM2305A0	6 SERIES DOOR CAP FIXING PAWL	7	PZ																																														
K0B1122AL	CHEFTOP MM LEFT DOOR LOWER BEAM KIT	<table border="1"> <thead> <tr> <th>Code</th> <th>Description</th> <th>Qty</th> <th>UOM</th> </tr> </thead> <tbody> <tr> <td>0B1122A0</td> <td>6 SERIES DOOR LOWER FRAME SHAPE</td> <td>1</td> <td>PZ</td> </tr> <tr> <td>RC1200A0</td> <td>ED=4 WIRE D.=0.5 COMPRESSIO N SPRING</td> <td>2</td> <td>PZ</td> </tr> <tr> <td>VI1220A1</td> <td>4,2X12 TCB SELF-TAPPIN G SCREW</td> <td>1</td> <td>PZ</td> </tr> <tr> <td>VI1996A0</td> <td>M5X35 SCREW</td> <td>7</td> <td>PZ</td> </tr> <tr> <td>VM1794A0</td> <td>250X4.8 PA66 BLACK CLAMP</td> <td>2</td> <td>PZ</td> </tr> <tr> <td>VM2103A0</td> <td>CLAMP LOCK</td> <td>2</td> <td>PZ</td> </tr> <tr> <td>VM2267A0</td> <td>INTERNAL GLASS LOCKING SYSTEM SLIDER</td> <td>1</td> <td>PZ</td> </tr> <tr> <td>VM2269A0</td> <td>INTERNAL GLASS LOCKING SYSTEM CAP</td> <td>1</td> <td>PZ</td> </tr> <tr> <td>VM2274A0</td> <td>GROOVED BUSHING</td> <td>1</td> <td>PZ</td> </tr> </tbody> </table>	Code	Description	Qty	UOM	0B1122A0	6 SERIES DOOR LOWER FRAME SHAPE	1	PZ	RC1200A0	ED=4 WIRE D.=0.5 COMPRESSIO N SPRING	2	PZ	VI1220A1	4,2X12 TCB SELF-TAPPIN G SCREW	1	PZ	VI1996A0	M5X35 SCREW	7	PZ	VM1794A0	250X4.8 PA66 BLACK CLAMP	2	PZ	VM2103A0	CLAMP LOCK	2	PZ	VM2267A0	INTERNAL GLASS LOCKING SYSTEM SLIDER	1	PZ	VM2269A0	INTERNAL GLASS LOCKING SYSTEM CAP	1	PZ	VM2274A0	GROOVED BUSHING	1	PZ							
Code	Description	Qty	UOM																																														
0B1122A0	6 SERIES DOOR LOWER FRAME SHAPE	1	PZ																																														
RC1200A0	ED=4 WIRE D.=0.5 COMPRESSIO N SPRING	2	PZ																																														
VI1220A1	4,2X12 TCB SELF-TAPPIN G SCREW	1	PZ																																														
VI1996A0	M5X35 SCREW	7	PZ																																														
VM1794A0	250X4.8 PA66 BLACK CLAMP	2	PZ																																														
VM2103A0	CLAMP LOCK	2	PZ																																														
VM2267A0	INTERNAL GLASS LOCKING SYSTEM SLIDER	1	PZ																																														
VM2269A0	INTERNAL GLASS LOCKING SYSTEM CAP	1	PZ																																														
VM2274A0	GROOVED BUSHING	1	PZ																																														





COMPONENT			SPARE PART																										
Code	Description	Image	Code	Description	Components list																								
VM2261A	6 SERIES DOOR LOWER RIGHT CAP		K0B1122AL	CHEFTOP MM LEFT DOOR LOWER BEAM KIT	<table border="1"> <thead> <tr> <th>Code</th> <th>Description</th> <th>Qty</th> <th>UOM</th> </tr> </thead> <tbody> <tr> <td>VM2305A0</td> <td>6 SERIES DOOR CAP FIXING PAWL</td> <td>7</td> <td>PZ</td> </tr> <tr> <td>VM2384A0</td> <td>LEFT MM DOOR LOWER RIGHT CAP</td> <td>1</td> <td>PZ</td> </tr> <tr> <td>VM2386A1</td> <td>LEFT MM DOOR LOWER LEFT CAP</td> <td>1</td> <td>PZ</td> </tr> </tbody> </table>	Code	Description	Qty	UOM	VM2305A0	6 SERIES DOOR CAP FIXING PAWL	7	PZ	VM2384A0	LEFT MM DOOR LOWER RIGHT CAP	1	PZ	VM2386A1	LEFT MM DOOR LOWER LEFT CAP	1	PZ								
Code	Description	Qty	UOM																										
VM2305A0	6 SERIES DOOR CAP FIXING PAWL	7	PZ																										
VM2384A0	LEFT MM DOOR LOWER RIGHT CAP	1	PZ																										
VM2386A1	LEFT MM DOOR LOWER LEFT CAP	1	PZ																										
PE2044A	MM PLUS VERSION CONTROL BOARD		KPE2044A	MIND.MAPS PLUS CONTROL BOARD KIT	<table border="1"> <thead> <tr> <th>Code</th> <th>Description</th> <th>Qty</th> <th>UOM</th> </tr> </thead> <tbody> <tr> <td>PE2044A0</td> <td>MM PLUS VERSION CONTROL BOARD</td> <td>1</td> <td>PZ</td> </tr> <tr> <td>PE2044A1</td> <td>MM PLUS VERSION CONTROL BOARD</td> <td>1</td> <td>PZ</td> </tr> <tr> <td>PE2044A2</td> <td>MM PLUS VERSION CONTROL BOARD</td> <td>1</td> <td>PZ</td> </tr> <tr> <td>VI2000A0</td> <td>SCREW M4X22 TCB+ INOX</td> <td>4</td> <td>PZ</td> </tr> <tr> <td>VM2147A0</td> <td>ESD SPONGE PINK SMOOTH 410X343X15 M</td> <td>1</td> <td>PZ</td> </tr> </tbody> </table>	Code	Description	Qty	UOM	PE2044A0	MM PLUS VERSION CONTROL BOARD	1	PZ	PE2044A1	MM PLUS VERSION CONTROL BOARD	1	PZ	PE2044A2	MM PLUS VERSION CONTROL BOARD	1	PZ	VI2000A0	SCREW M4X22 TCB+ INOX	4	PZ	VM2147A0	ESD SPONGE PINK SMOOTH 410X343X15 M	1	PZ
Code	Description	Qty	UOM																										
PE2044A0	MM PLUS VERSION CONTROL BOARD	1	PZ																										
PE2044A1	MM PLUS VERSION CONTROL BOARD	1	PZ																										
PE2044A2	MM PLUS VERSION CONTROL BOARD	1	PZ																										
VI2000A0	SCREW M4X22 TCB+ INOX	4	PZ																										
VM2147A0	ESD SPONGE PINK SMOOTH 410X343X15 M	1	PZ																										
VM2315A	6 S. INTERNAL GLASS CAP SUPPORT		KVM2315A	MM INTERNAL GLASS SUPPORT KI	<table border="1"> <thead> <tr> <th>Code</th> <th>Description</th> <th>Qty</th> <th>UOM</th> </tr> </thead> <tbody> <tr> <td>VI1220A1</td> <td>4,2X12 TCB SELF-TAPPIN G SCREW</td> <td>3</td> <td>PZ</td> </tr> <tr> <td>VM1630A0</td> <td>INTERNAL GLASS PUSHING CAP</td> <td>3</td> <td>PZ</td> </tr> <tr> <td>VM2315A0</td> <td>6 S. INTERNAL GLASS CAP SUPPORT</td> <td>3</td> <td>PZ</td> </tr> </tbody> </table>	Code	Description	Qty	UOM	VI1220A1	4,2X12 TCB SELF-TAPPIN G SCREW	3	PZ	VM1630A0	INTERNAL GLASS PUSHING CAP	3	PZ	VM2315A0	6 S. INTERNAL GLASS CAP SUPPORT	3	PZ								
Code	Description	Qty	UOM																										
VI1220A1	4,2X12 TCB SELF-TAPPIN G SCREW	3	PZ																										
VM1630A0	INTERNAL GLASS PUSHING CAP	3	PZ																										
VM2315A0	6 S. INTERNAL GLASS CAP SUPPORT	3	PZ																										
VM1630A	INTERNAL GLASS PUSHING CAP		KVM2315A	MM INTERNAL GLASS SUPPORT KI	<table border="1"> <thead> <tr> <th>Code</th> <th>Description</th> <th>Qty</th> <th>UOM</th> </tr> </thead> <tbody> <tr> <td>VI1220A1</td> <td>4,2X12 TCB SELF-TAPPIN G SCREW</td> <td>3</td> <td>PZ</td> </tr> <tr> <td>VM1630A0</td> <td>INTERNAL GLASS PUSHING CAP</td> <td>3</td> <td>PZ</td> </tr> <tr> <td>VM2315A0</td> <td>6 S. INTERNAL GLASS CAP SUPPORT</td> <td>3</td> <td>PZ</td> </tr> </tbody> </table>	Code	Description	Qty	UOM	VI1220A1	4,2X12 TCB SELF-TAPPIN G SCREW	3	PZ	VM1630A0	INTERNAL GLASS PUSHING CAP	3	PZ	VM2315A0	6 S. INTERNAL GLASS CAP SUPPORT	3	PZ								
Code	Description	Qty	UOM																										
VI1220A1	4,2X12 TCB SELF-TAPPIN G SCREW	3	PZ																										
VM1630A0	INTERNAL GLASS PUSHING CAP	3	PZ																										
VM2315A0	6 S. INTERNAL GLASS CAP SUPPORT	3	PZ																										

COMPONENT			SPARE PART																		
Code	Description	Image	Code	Description	Components list																
VM1630A	INTERNAL GLASS PUSHING CAP		KVM1591A	S.5E INT. GLASS H35 PUSHING BRACKET KIT	<table border="1"> <thead> <tr> <th>Code</th> <th>Description</th> <th>Qty</th> <th>UOM</th> </tr> </thead> <tbody> <tr> <td>VI1220A1</td> <td>4,2X12 TCB SELF-TAPPIN G SCREW</td> <td>2</td> <td>PZ</td> </tr> <tr> <td>VM1591A0</td> <td>GLASS BRACKET INT. XVC1004</td> <td>1</td> <td>PZ</td> </tr> <tr> <td>VM1630A0</td> <td>INTERNAL GLASS PUSHING CAP</td> <td>2</td> <td>PZ</td> </tr> </tbody> </table>	Code	Description	Qty	UOM	VI1220A1	4,2X12 TCB SELF-TAPPIN G SCREW	2	PZ	VM1591A0	GLASS BRACKET INT. XVC1004	1	PZ	VM1630A0	INTERNAL GLASS PUSHING CAP	2	PZ
			Code	Description	Qty	UOM															
VI1220A1	4,2X12 TCB SELF-TAPPIN G SCREW	2	PZ																		
VM1591A0	GLASS BRACKET INT. XVC1004	1	PZ																		
VM1630A0	INTERNAL GLASS PUSHING CAP	2	PZ																		
KVM1590A	S.5 INT. GLASS H25 PUSHING BRACKET KIT	<table border="1"> <thead> <tr> <th>Code</th> <th>Description</th> <th>Qty</th> <th>UOM</th> </tr> </thead> <tbody> <tr> <td>VI1220A1</td> <td>4,2X12 TCB SELF-TAPPIN G SCREW</td> <td>2</td> <td>PZ</td> </tr> <tr> <td>VM1590A0</td> <td>XVC705 XBC805 GLASS PUSHING BRACKET</td> <td>1</td> <td>PZ</td> </tr> <tr> <td>VM1630A0</td> <td>INTERNAL GLASS PUSHING CAP</td> <td>2</td> <td>PZ</td> </tr> </tbody> </table>	Code	Description	Qty	UOM	VI1220A1	4,2X12 TCB SELF-TAPPIN G SCREW	2	PZ	VM1590A0	XVC705 XBC805 GLASS PUSHING BRACKET	1	PZ	VM1630A0	INTERNAL GLASS PUSHING CAP	2	PZ			
Code	Description	Qty	UOM																		
VI1220A1	4,2X12 TCB SELF-TAPPIN G SCREW	2	PZ																		
VM1590A0	XVC705 XBC805 GLASS PUSHING BRACKET	1	PZ																		
VM1630A0	INTERNAL GLASS PUSHING CAP	2	PZ																		
VM2371A	DOUBLE GLASS DOOR PUSHING BRACKET		KVM2371A	INTERNAL DOUBLE GLASS SUPPORT 3 PCS KIT	<table border="1"> <thead> <tr> <th>Code</th> <th>Description</th> <th>Qty</th> <th>UOM</th> </tr> </thead> <tbody> <tr> <td>VI1220A1</td> <td>4,2X12 TCB SELF-TAPPIN G SCREW</td> <td>3</td> <td>PZ</td> </tr> <tr> <td>VM2371A0</td> <td>DOUBLE GLASS DOOR PUSHING BRACKET</td> <td>3</td> <td>PZ</td> </tr> </tbody> </table>	Code	Description	Qty	UOM	VI1220A1	4,2X12 TCB SELF-TAPPIN G SCREW	3	PZ	VM2371A0	DOUBLE GLASS DOOR PUSHING BRACKET	3	PZ				
Code	Description	Qty	UOM																		
VI1220A1	4,2X12 TCB SELF-TAPPIN G SCREW	3	PZ																		
VM2371A0	DOUBLE GLASS DOOR PUSHING BRACKET	3	PZ																		
VN1177A	CONTROL BOARD COOLING FAN		KVN1179A	CONTROL BOARD COOLING FAN KIT	<table border="1"> <thead> <tr> <th>Code</th> <th>Description</th> <th>Qty</th> <th>UOM</th> </tr> </thead> <tbody> <tr> <td>VN1179A0</td> <td>CONTROL BOARD COOLING FAN</td> <td>1</td> <td>PZ</td> </tr> </tbody> </table>	Code	Description	Qty	UOM	VN1179A0	CONTROL BOARD COOLING FAN	1	PZ								
			Code	Description	Qty	UOM															
VN1179A0	CONTROL BOARD COOLING FAN	1	PZ																		
KVN1177A	CONTROL BOARD COOLING FAN KIT	<table border="1"> <thead> <tr> <th>Code</th> <th>Description</th> <th>Qty</th> <th>UOM</th> </tr> </thead> <tbody> <tr> <td>VN1177A0</td> <td>CONTROL BOARD COOLING FAN</td> <td>1</td> <td>PZ</td> </tr> </tbody> </table>	Code	Description	Qty	UOM	VN1177A0	CONTROL BOARD COOLING FAN	1	PZ											
Code	Description	Qty	UOM																		
VN1177A0	CONTROL BOARD COOLING FAN	1	PZ																		
VM2316A	CONTROL BOARD COOLING FAN HOLDER		KVM2518A	PANEL COOLING FAN SUPPORT KIT	<table border="1"> <thead> <tr> <th>Code</th> <th>Description</th> <th>Qty</th> <th>UOM</th> </tr> </thead> <tbody> <tr> <td>VM2518A0</td> <td>BOARD COOLING FAN SUPPORT</td> <td>1</td> <td>PZ</td> </tr> </tbody> </table>	Code	Description	Qty	UOM	VM2518A0	BOARD COOLING FAN SUPPORT	1	PZ								
			Code	Description	Qty	UOM															
VM2518A0	BOARD COOLING FAN SUPPORT	1	PZ																		
KVM2316A	PANEL COOLING FAN SUPPORT KIT	<table border="1"> <thead> <tr> <th>Code</th> <th>Description</th> <th>Qty</th> <th>UOM</th> </tr> </thead> <tbody> <tr> <td>VM2316A0</td> <td>CONTROL BOARD COOLING FAN HOLDER</td> <td>1</td> <td>PZ</td> </tr> </tbody> </table>	Code	Description	Qty	UOM	VM2316A0	CONTROL BOARD COOLING FAN HOLDER	1	PZ											
Code	Description	Qty	UOM																		
VM2316A0	CONTROL BOARD COOLING FAN HOLDER	1	PZ																		



COMPONENT			SPARE PART										
Code	Description	Image	Code	Description	Components list								
CE1053B	MM MICROFIT LED BAR POWER SUPPLY CABLE												
VM2312A	6 S. DRIP PROFILE DRAIN LEFT PIPE		KVM2312A	M.M. DRIP TRAY LEFT DRAIN PIPE KI	<table border="1"> <thead> <tr> <th>Code</th> <th>Description</th> <th>Qty</th> <th>UOM</th> </tr> </thead> <tbody> <tr> <td>VM2312A0</td> <td>6 S. DRIP PROFILE DRAIN LEFT PIPE</td> <td>1</td> <td>PZ</td> </tr> </tbody> </table>	Code	Description	Qty	UOM	VM2312A0	6 S. DRIP PROFILE DRAIN LEFT PIPE	1	PZ
Code	Description	Qty	UOM										
VM2312A0	6 S. DRIP PROFILE DRAIN LEFT PIPE	1	PZ										
VM2314A	6 S. DRIP PROFILE CAP		KVM2314A	MIND.MAPS DRIP TRAY CAP	<table border="1"> <thead> <tr> <th>Code</th> <th>Description</th> <th>Qty</th> <th>UOM</th> </tr> </thead> <tbody> <tr> <td>VM2314A0</td> <td>6 S. DRIP PROFILE CAP</td> <td>1</td> <td>PZ</td> </tr> </tbody> </table>	Code	Description	Qty	UOM	VM2314A0	6 S. DRIP PROFILE CAP	1	PZ
Code	Description	Qty	UOM										
VM2314A0	6 S. DRIP PROFILE CAP	1	PZ										
VM2285A	860 SERIES DRIP PROFILE		KVM2285A	860 SERIES DRIP PROFILE KIT	<table border="1"> <thead> <tr> <th>Code</th> <th>Description</th> <th>Qty</th> <th>UOM</th> </tr> </thead> <tbody> <tr> <td>VM2285A0</td> <td>860 SERIES DRIP PROFILE</td> <td>1</td> <td>PZ</td> </tr> </tbody> </table>	Code	Description	Qty	UOM	VM2285A0	860 SERIES DRIP PROFILE	1	PZ
Code	Description	Qty	UOM										
VM2285A0	860 SERIES DRIP PROFILE	1	PZ										
VM2313A	TUBE DX DISCHARGE DRIP M		KVM2313A	MM DRIP PROFILE DRAIN RIGHT PIPE KIT	<table border="1"> <thead> <tr> <th>Code</th> <th>Description</th> <th>Qty</th> <th>UOM</th> </tr> </thead> <tbody> <tr> <td>VM2313A0</td> <td>TUBE DX DISCHARGE DRIP MM</td> <td>1</td> <td>PZ</td> </tr> </tbody> </table>	Code	Description	Qty	UOM	VM2313A0	TUBE DX DISCHARGE DRIP MM	1	PZ
Code	Description	Qty	UOM										
VM2313A0	TUBE DX DISCHARGE DRIP MM	1	PZ										

COMPONENT			SPARE PART																																		
Code	Description	Image	Code	Description	Components list																																
0B1171A	XEBC-10EU-E RIGHT EXT DOOR COLUMN		0B1171A0	XEBC-10EU-E RIGHT EXT DOOR COLUMN																																	
VT1292A	XEBC-10EU-E EXTERNAL GLASS		KVT1292A	10EU-1021 EXTERNAL GLASS KIT	<table border="1"> <thead> <tr> <th>Code</th> <th>Description</th> <th>Qty</th> <th>UOM</th> </tr> </thead> <tbody> <tr> <td>0B1173A0</td> <td>EXT. GLASS SUPPORT PROFILE</td> <td>2</td> <td>PZ</td> </tr> <tr> <td>IP1508A0</td> <td></td> <td>1</td> <td>PZ</td> </tr> <tr> <td>IP1508A1</td> <td>POLYSTYREN E U SHAPED PROFILE 2000X60X60</td> <td>1</td> <td>M</td> </tr> <tr> <td>SL1155A1</td> <td>SILICON BICOMPONEN T LOCTITE</td> <td>150</td> <td>ML</td> </tr> <tr> <td>SL1156A0</td> <td>NOZZLE FOR SILICON GUN</td> <td>1</td> <td>PZ</td> </tr> <tr> <td>VM1059A1</td> <td>HEAT SHRINK FILM H800</td> <td>1.500</td> <td>M</td> </tr> <tr> <td>VT1292A0</td> <td>XEBC-10EU-E EXTERNAL GLASS</td> <td>1</td> <td>PZ</td> </tr> </tbody> </table>	Code	Description	Qty	UOM	0B1173A0	EXT. GLASS SUPPORT PROFILE	2	PZ	IP1508A0		1	PZ	IP1508A1	POLYSTYREN E U SHAPED PROFILE 2000X60X60	1	M	SL1155A1	SILICON BICOMPONEN T LOCTITE	150	ML	SL1156A0	NOZZLE FOR SILICON GUN	1	PZ	VM1059A1	HEAT SHRINK FILM H800	1.500	M	VT1292A0	XEBC-10EU-E EXTERNAL GLASS	1	PZ
Code	Description	Qty	UOM																																		
0B1173A0	EXT. GLASS SUPPORT PROFILE	2	PZ																																		
IP1508A0		1	PZ																																		
IP1508A1	POLYSTYREN E U SHAPED PROFILE 2000X60X60	1	M																																		
SL1155A1	SILICON BICOMPONEN T LOCTITE	150	ML																																		
SL1156A0	NOZZLE FOR SILICON GUN	1	PZ																																		
VM1059A1	HEAT SHRINK FILM H800	1.500	M																																		
VT1292A0	XEBC-10EU-E EXTERNAL GLASS	1	PZ																																		
0B1173A	EXT. GLASS SUPPORT PROFILE		0B1173A0	EXT. GLASS SUPPORT PROFILE																																	
LP1022A	6 SERIES L600 LED LIGHT BAR - E903		KLP1022A	L600 E9003 LED LIGHT BAR KIT	<table border="1"> <thead> <tr> <th>Code</th> <th>Description</th> <th>Qty</th> <th>UOM</th> </tr> </thead> <tbody> <tr> <td>IP1385A1</td> <td>CORNER POLYSTYREN E PACKING 110X80X2000</td> <td>1.940</td> <td>M</td> </tr> <tr> <td>LP1022A0</td> <td>6 SERIES L600 LED LIGHT BAR - E903</td> <td>1</td> <td>PZ</td> </tr> <tr> <td>VM1058A1</td> <td>HEAT SHRINK FILM H410</td> <td>1.940</td> <td>M</td> </tr> <tr> <td>VM1059A1</td> <td>HEAT SHRINK FILM H800</td> <td>1.940</td> <td>M</td> </tr> </tbody> </table>	Code	Description	Qty	UOM	IP1385A1	CORNER POLYSTYREN E PACKING 110X80X2000	1.940	M	LP1022A0	6 SERIES L600 LED LIGHT BAR - E903	1	PZ	VM1058A1	HEAT SHRINK FILM H410	1.940	M	VM1059A1	HEAT SHRINK FILM H800	1.940	M												
Code	Description	Qty	UOM																																		
IP1385A1	CORNER POLYSTYREN E PACKING 110X80X2000	1.940	M																																		
LP1022A0	6 SERIES L600 LED LIGHT BAR - E903	1	PZ																																		
VM1058A1	HEAT SHRINK FILM H410	1.940	M																																		
VM1059A1	HEAT SHRINK FILM H800	1.940	M																																		

COMPONENT			SPARE PART																						
Code	Description	Image	Code	Description	Components list																				
LP1028A	L=903 S6 NO LED LIGHT BAR COVER		KLP1028A	L903 MM NO LED LIGHT HOLDER KIT	<table border="1"> <thead> <tr> <th>Code</th> <th>Description</th> <th>Qty</th> <th>UOM</th> </tr> </thead> <tbody> <tr> <td>IP1385A1</td> <td>CORNER POLYSTYREN E PACKING 110X80X2000</td> <td>1.940</td> <td>M</td> </tr> <tr> <td>LP1028A0</td> <td>L=903 S6 NO LED LIGHT BAR COVER</td> <td>1</td> <td>PZ</td> </tr> <tr> <td>VM1058A1</td> <td>HEAT SHRINK FILM H410</td> <td>1.940</td> <td>M</td> </tr> <tr> <td>VM1059A1</td> <td>HEAT SHRINK FILM H800</td> <td>1.940</td> <td>M</td> </tr> </tbody> </table>	Code	Description	Qty	UOM	IP1385A1	CORNER POLYSTYREN E PACKING 110X80X2000	1.940	M	LP1028A0	L=903 S6 NO LED LIGHT BAR COVER	1	PZ	VM1058A1	HEAT SHRINK FILM H410	1.940	M	VM1059A1	HEAT SHRINK FILM H800	1.940	M
Code	Description	Qty	UOM																						
IP1385A1	CORNER POLYSTYREN E PACKING 110X80X2000	1.940	M																						
LP1028A0	L=903 S6 NO LED LIGHT BAR COVER	1	PZ																						
VM1058A1	HEAT SHRINK FILM H410	1.940	M																						
VM1059A1	HEAT SHRINK FILM H800	1.940	M																						
VI1034A	STAINLESS STEEL WASHER 8.4X16X1		VI1034A0	STAINLESS STEEL WASHER 8.4X16X1																					
CE1052A	CABLE CONNECTION CONTROL - USB MM 750MM		KCE1052A	CONTROL BOARD-USB 650 CONN. CABLE KIT	<table border="1"> <thead> <tr> <th>Code</th> <th>Description</th> <th>Qty</th> <th>UOM</th> </tr> </thead> <tbody> <tr> <td>CE1052A0</td> <td>S6 USB CONNECTION CABLE LONG</td> <td>1</td> <td>PZ</td> </tr> <tr> <td>CE1052A1</td> <td>CABLE CONNECTION CONTROL - USB MM 750M</td> <td>1</td> <td>PZ</td> </tr> </tbody> </table>	Code	Description	Qty	UOM	CE1052A0	S6 USB CONNECTION CABLE LONG	1	PZ	CE1052A1	CABLE CONNECTION CONTROL - USB MM 750M	1	PZ								
Code	Description	Qty	UOM																						
CE1052A0	S6 USB CONNECTION CABLE LONG	1	PZ																						
CE1052A1	CABLE CONNECTION CONTROL - USB MM 750M	1	PZ																						
0B1169A	XEBC-10EU-E LEFT EXT DOOR COLUMN		0B1169A0	XEBC-10EU-E LEFT EXT DOOR COLUMN																					
0B1218A	MM DOUBLE GLASS DOOR UPPER BEAM 860		0B1218A0	MM DOUBLE GLASS DOOR UPPER BEAM 860																					

COMPONENT			SPARE PART																																										
Code	Description	Image	Code	Description	Components list																																								
CR1105A	HINGES INTERNAL GLASS DOUBLE		KCR1105A	MIND.MAPS PLUS INTERNAL GLASS HINGES KIT	<table border="1"> <thead> <tr> <th>Code</th> <th>Description</th> <th>Qty</th> <th>UOM</th> </tr> </thead> <tbody> <tr> <td>CR1105A0</td> <td>HINGES INTERNAL GLASS DOUBL</td> <td>1</td> <td>PZ</td> </tr> <tr> <td>CR1106A0</td> <td>HINGES INTERNAL GLASS DOUBL</td> <td>1</td> <td>PZ</td> </tr> <tr> <td>VI1220A1</td> <td>4,2X12 TCB SELF-TAPPIN G SCREW</td> <td>4</td> <td>PZ</td> </tr> </tbody> </table>	Code	Description	Qty	UOM	CR1105A0	HINGES INTERNAL GLASS DOUBL	1	PZ	CR1106A0	HINGES INTERNAL GLASS DOUBL	1	PZ	VI1220A1	4,2X12 TCB SELF-TAPPIN G SCREW	4	PZ																								
Code	Description	Qty	UOM																																										
CR1105A0	HINGES INTERNAL GLASS DOUBL	1	PZ																																										
CR1106A0	HINGES INTERNAL GLASS DOUBL	1	PZ																																										
VI1220A1	4,2X12 TCB SELF-TAPPIN G SCREW	4	PZ																																										
CR1106A	HINGES INTERNAL GLASS DOUBLE		KCR1105A	MIND.MAPS PLUS INTERNAL GLASS HINGES KIT	<table border="1"> <thead> <tr> <th>Code</th> <th>Description</th> <th>Qty</th> <th>UOM</th> </tr> </thead> <tbody> <tr> <td>CR1105A0</td> <td>HINGES INTERNAL GLASS DOUBL</td> <td>1</td> <td>PZ</td> </tr> <tr> <td>CR1106A0</td> <td>HINGES INTERNAL GLASS DOUBL</td> <td>1</td> <td>PZ</td> </tr> <tr> <td>VI1220A1</td> <td>4,2X12 TCB SELF-TAPPIN G SCREW</td> <td>4</td> <td>PZ</td> </tr> </tbody> </table>	Code	Description	Qty	UOM	CR1105A0	HINGES INTERNAL GLASS DOUBL	1	PZ	CR1106A0	HINGES INTERNAL GLASS DOUBL	1	PZ	VI1220A1	4,2X12 TCB SELF-TAPPIN G SCREW	4	PZ																								
Code	Description	Qty	UOM																																										
CR1105A0	HINGES INTERNAL GLASS DOUBL	1	PZ																																										
CR1106A0	HINGES INTERNAL GLASS DOUBL	1	PZ																																										
VI1220A1	4,2X12 TCB SELF-TAPPIN G SCREW	4	PZ																																										
VT1298A	INT. GLASS SER. 10EU 749X942X4 2V		KVT1298A	10EU INNER DOUBLE GLASS KIT	<table border="1"> <thead> <tr> <th>Code</th> <th>Description</th> <th>Qty</th> <th>UOM</th> </tr> </thead> <tbody> <tr> <td>0B1185A0</td> <td>BT INT DOUBLE GLASS INF-SUP BEAM</td> <td>2</td> <td>PZ</td> </tr> <tr> <td>0B1188A0</td> <td>10EU DOUBLE GLASS RIGHT-LEFT PROFILE</td> <td>2</td> <td>PZ</td> </tr> <tr> <td>0B1211A0</td> <td>BT DOUBLE GLASS EXT SUP-INF PROFILE</td> <td>2</td> <td>PZ</td> </tr> <tr> <td>0B1215A0</td> <td>10EU DOUBLE GLASS EXT SUP-INF PROFILE</td> <td>2</td> <td>PZ</td> </tr> <tr> <td>CR1105A0</td> <td>HINGES INTERNAL GLASS DOUBL</td> <td>1</td> <td>PZ</td> </tr> <tr> <td>CR1106A0</td> <td>HINGES INTERNAL GLASS DOUBL</td> <td>1</td> <td>PZ</td> </tr> <tr> <td>IP1508A0</td> <td></td> <td>2</td> <td>PZ</td> </tr> <tr> <td>IP1508A1</td> <td>POLYSTYREN E U SHAPED PROFILE 2000X60X60</td> <td>2</td> <td>M</td> </tr> <tr> <td>VI1220A1</td> <td>4,2X12 TCB SELF-TAPPIN G SCREW</td> <td>4</td> <td>PZ</td> </tr> </tbody> </table>	Code	Description	Qty	UOM	0B1185A0	BT INT DOUBLE GLASS INF-SUP BEAM	2	PZ	0B1188A0	10EU DOUBLE GLASS RIGHT-LEFT PROFILE	2	PZ	0B1211A0	BT DOUBLE GLASS EXT SUP-INF PROFILE	2	PZ	0B1215A0	10EU DOUBLE GLASS EXT SUP-INF PROFILE	2	PZ	CR1105A0	HINGES INTERNAL GLASS DOUBL	1	PZ	CR1106A0	HINGES INTERNAL GLASS DOUBL	1	PZ	IP1508A0		2	PZ	IP1508A1	POLYSTYREN E U SHAPED PROFILE 2000X60X60	2	M	VI1220A1	4,2X12 TCB SELF-TAPPIN G SCREW	4	PZ
Code	Description	Qty	UOM																																										
0B1185A0	BT INT DOUBLE GLASS INF-SUP BEAM	2	PZ																																										
0B1188A0	10EU DOUBLE GLASS RIGHT-LEFT PROFILE	2	PZ																																										
0B1211A0	BT DOUBLE GLASS EXT SUP-INF PROFILE	2	PZ																																										
0B1215A0	10EU DOUBLE GLASS EXT SUP-INF PROFILE	2	PZ																																										
CR1105A0	HINGES INTERNAL GLASS DOUBL	1	PZ																																										
CR1106A0	HINGES INTERNAL GLASS DOUBL	1	PZ																																										
IP1508A0		2	PZ																																										
IP1508A1	POLYSTYREN E U SHAPED PROFILE 2000X60X60	2	M																																										
VI1220A1	4,2X12 TCB SELF-TAPPIN G SCREW	4	PZ																																										



COMPONENT			SPARE PART																		
Code	Description	Image	Code	Description	Components list																
VT1298A	INT. GLASS SER. 10EU 749X942X4 2V		KVT1298A	10EU INNER DOUBLE GLASS KIT	<table border="1"> <thead> <tr> <th>Code</th> <th>Description</th> <th>Qty</th> <th>UOM</th> </tr> </thead> <tbody> <tr> <td>VI1225A0</td> <td>STAINLESS STEEL STRUCTURE RIVET 4X10.1</td> <td>20</td> <td>PZ</td> </tr> <tr> <td>VM1059A1</td> <td>HEAT SHRINK FILM H800</td> <td>1.500</td> <td>M</td> </tr> <tr> <td>VT1298A1</td> <td>INT. GLASS SER. 10EU 749X942X4 2V</td> <td>1</td> <td>PZ</td> </tr> </tbody> </table>	Code	Description	Qty	UOM	VI1225A0	STAINLESS STEEL STRUCTURE RIVET 4X10.1	20	PZ	VM1059A1	HEAT SHRINK FILM H800	1.500	M	VT1298A1	INT. GLASS SER. 10EU 749X942X4 2V	1	PZ
Code	Description	Qty	UOM																		
VI1225A0	STAINLESS STEEL STRUCTURE RIVET 4X10.1	20	PZ																		
VM1059A1	HEAT SHRINK FILM H800	1.500	M																		
VT1298A1	INT. GLASS SER. 10EU 749X942X4 2V	1	PZ																		
VM2410A	PLATE TO STOP EXTRUDED LED BAR		KVM2410A	PLATE TO STOP EXTRUDED LED BAR 2P KIT	<table border="1"> <thead> <tr> <th>Code</th> <th>Description</th> <th>Qty</th> <th>UOM</th> </tr> </thead> <tbody> <tr> <td>0B1190A0</td> <td>PLATE TO STOP EXTRUDED LED BAR</td> <td>2</td> <td>PZ</td> </tr> <tr> <td>VM2410A0</td> <td>PLATE TO STOP EXTRUDED LED BAR</td> <td>2</td> <td>PZ</td> </tr> </tbody> </table>	Code	Description	Qty	UOM	0B1190A0	PLATE TO STOP EXTRUDED LED BAR	2	PZ	VM2410A0	PLATE TO STOP EXTRUDED LED BAR	2	PZ				
Code	Description	Qty	UOM																		
0B1190A0	PLATE TO STOP EXTRUDED LED BAR	2	PZ																		
VM2410A0	PLATE TO STOP EXTRUDED LED BAR	2	PZ																		
VM2305A	6 SERIES DOOR CAP FIXING PAWL		VM2305A0	6 SERIES DOOR CAP FIXING PAWL																	
VM2275A	SMOOTH BUSHING		KVM2275A	SMOOTH PIN BUSHING KIT	<table border="1"> <thead> <tr> <th>Code</th> <th>Description</th> <th>Qty</th> <th>UOM</th> </tr> </thead> <tbody> <tr> <td>VM2275A0</td> <td>SMOOTH BUSHING</td> <td>1</td> <td>PZ</td> </tr> </tbody> </table>	Code	Description	Qty	UOM	VM2275A0	SMOOTH BUSHING	1	PZ								
Code	Description	Qty	UOM																		
VM2275A0	SMOOTH BUSHING	1	PZ																		
VI1996A	M5X35 SCREW		VI1996A0	M5X35 SCREW																	









COMPONENT			SPARE PART																																						
Code	Description	Image	Code	Description	Components list																																				
VM2260A	6 SERIES DOOR UPPER LEFT CAP		KVM2260A	MIND.MAPS DOOR LEFT UPPER CAP KI	<table border="1"> <thead> <tr> <th>Code</th> <th>Description</th> <th>Qty</th> <th>UOM</th> </tr> </thead> <tbody> <tr> <td>VM2260A1</td> <td>6 SERIES DOOR UPPER LEFT CAP</td> <td>1</td> <td>PZ</td> </tr> </tbody> </table>	Code	Description	Qty	UOM	VM2260A1	6 SERIES DOOR UPPER LEFT CAP	1	PZ																												
Code	Description	Qty	UOM																																						
VM2260A1	6 SERIES DOOR UPPER LEFT CAP	1	PZ																																						
VM2417A	PIN M10 DOOR CAP 6 SERIES MV																																								
VI1962A	ST. STEEL M10 BLIND NUT																																								
OB1126A	DOOR LOWER FRAME SHAPE 860 MM		KOB1126AR	BAKERTOP RIGHT DOOR LOWER BEAM KIT	<table border="1"> <thead> <tr> <th>Code</th> <th>Description</th> <th>Qty</th> <th>UOM</th> </tr> </thead> <tbody> <tr> <td>OB1126A0</td> <td>DOOR LOWER FRAME SHAPE 860 MM</td> <td>1</td> <td>PZ</td> </tr> <tr> <td>RC1200A0</td> <td>ED=4 WIRE D.=0.5 COMPRESSIO N SPRING</td> <td>2</td> <td>PZ</td> </tr> <tr> <td>VI1220A1</td> <td>4,2X12 TCB SELF-TAPPIN G SCREW</td> <td>1</td> <td>PZ</td> </tr> <tr> <td>VI1996A0</td> <td>MSX35 SCREW</td> <td>7</td> <td>PZ</td> </tr> <tr> <td>VM1794A0</td> <td>250X4.8 PA66 BLACK CLAMP</td> <td>2</td> <td>PZ</td> </tr> <tr> <td>VM2103A0</td> <td>CLAMP LOCK</td> <td>2</td> <td>PZ</td> </tr> <tr> <td>VM2259A1</td> <td>6 SERIES DOOR LOWER LEFT CAP</td> <td>1</td> <td>PZ</td> </tr> <tr> <td>VM2261A1</td> <td>6 SERIES DOOR LOWER RIGHT CAP</td> <td>1</td> <td>PZ</td> </tr> </tbody> </table>	Code	Description	Qty	UOM	OB1126A0	DOOR LOWER FRAME SHAPE 860 MM	1	PZ	RC1200A0	ED=4 WIRE D.=0.5 COMPRESSIO N SPRING	2	PZ	VI1220A1	4,2X12 TCB SELF-TAPPIN G SCREW	1	PZ	VI1996A0	MSX35 SCREW	7	PZ	VM1794A0	250X4.8 PA66 BLACK CLAMP	2	PZ	VM2103A0	CLAMP LOCK	2	PZ	VM2259A1	6 SERIES DOOR LOWER LEFT CAP	1	PZ	VM2261A1	6 SERIES DOOR LOWER RIGHT CAP	1	PZ
Code	Description	Qty	UOM																																						
OB1126A0	DOOR LOWER FRAME SHAPE 860 MM	1	PZ																																						
RC1200A0	ED=4 WIRE D.=0.5 COMPRESSIO N SPRING	2	PZ																																						
VI1220A1	4,2X12 TCB SELF-TAPPIN G SCREW	1	PZ																																						
VI1996A0	MSX35 SCREW	7	PZ																																						
VM1794A0	250X4.8 PA66 BLACK CLAMP	2	PZ																																						
VM2103A0	CLAMP LOCK	2	PZ																																						
VM2259A1	6 SERIES DOOR LOWER LEFT CAP	1	PZ																																						
VM2261A1	6 SERIES DOOR LOWER RIGHT CAP	1	PZ																																						



COMPONENT			SPARE PART																																																			
Code	Description	Image	Code	Description	Components list																																																	
OB1126A	DOOR LOWER FRAME SHAPE 860 MM		K0B1126AR	BAKERTOP RIGHT DOOR LOWER BEAM KIT	<table border="1"> <thead> <tr> <th>Code</th> <th>Description</th> <th>Qty</th> <th>UOM</th> </tr> </thead> <tbody> <tr> <td>VM2267A0</td> <td>INTERNAL GLASS LOCKING SYSTEM SLIDER</td> <td>1</td> <td>PZ</td> </tr> <tr> <td>VM2269A0</td> <td>INTERNAL GLASS LOCKING SYSTEM CAP</td> <td>1</td> <td>PZ</td> </tr> <tr> <td>VM2274A0</td> <td>GROOVED BUSHING</td> <td>1</td> <td>PZ</td> </tr> <tr> <td>VM2305A0</td> <td>6 SERIES DOOR CAP FIXING PAWL</td> <td>7</td> <td>PZ</td> </tr> </tbody> </table>	Code	Description	Qty	UOM	VM2267A0	INTERNAL GLASS LOCKING SYSTEM SLIDER	1	PZ	VM2269A0	INTERNAL GLASS LOCKING SYSTEM CAP	1	PZ	VM2274A0	GROOVED BUSHING	1	PZ	VM2305A0	6 SERIES DOOR CAP FIXING PAWL	7	PZ																													
			Code	Description	Qty	UOM																																																
VM2267A0	INTERNAL GLASS LOCKING SYSTEM SLIDER	1	PZ																																																			
VM2269A0	INTERNAL GLASS LOCKING SYSTEM CAP	1	PZ																																																			
VM2274A0	GROOVED BUSHING	1	PZ																																																			
VM2305A0	6 SERIES DOOR CAP FIXING PAWL	7	PZ																																																			
K0B1126AL	BAKERTOP LEFT DOOR LOWER BEAM KIT	<table border="1"> <thead> <tr> <th>Code</th> <th>Description</th> <th>Qty</th> <th>UOM</th> </tr> </thead> <tbody> <tr> <td>OB1126A0</td> <td>DOOR LOWER FRAME SHAPE 860 MM</td> <td>1</td> <td>PZ</td> </tr> <tr> <td>RC1200A0</td> <td>ED=4 WIRE D.=0.5 COMPRESSIO N SPRING</td> <td>2</td> <td>PZ</td> </tr> <tr> <td>VI1220A1</td> <td>4,2X12 TCB SELF-TAPPIN G SCREW</td> <td>1</td> <td>PZ</td> </tr> <tr> <td>VI1996A0</td> <td>M5X35 SCREW</td> <td>7</td> <td>PZ</td> </tr> <tr> <td>VM1794A0</td> <td>250X4.8 PA66 BLACK CLAMP</td> <td>2</td> <td>PZ</td> </tr> <tr> <td>VM2103A0</td> <td>CLAMP LOCK</td> <td>2</td> <td>PZ</td> </tr> <tr> <td>VM2267A0</td> <td>INTERNAL GLASS LOCKING SYSTEM SLIDER</td> <td>1</td> <td>PZ</td> </tr> <tr> <td>VM2269A0</td> <td>INTERNAL GLASS LOCKING SYSTEM CAP</td> <td>1</td> <td>PZ</td> </tr> <tr> <td>VM2274A0</td> <td>GROOVED BUSHING</td> <td>1</td> <td>PZ</td> </tr> <tr> <td>VM2305A0</td> <td>6 SERIES DOOR CAP FIXING PAWL</td> <td>7</td> <td>PZ</td> </tr> <tr> <td>VM2384A0</td> <td>LEFT MM DOOR LOWER RIGHT CAP</td> <td>1</td> <td>PZ</td> </tr> <tr> <td>VM2386A1</td> <td>LEFT MM DOOR LOWER LEFT CAP</td> <td>1</td> <td>PZ</td> </tr> </tbody> </table>	Code	Description	Qty	UOM	OB1126A0	DOOR LOWER FRAME SHAPE 860 MM	1	PZ	RC1200A0	ED=4 WIRE D.=0.5 COMPRESSIO N SPRING	2	PZ	VI1220A1	4,2X12 TCB SELF-TAPPIN G SCREW	1	PZ	VI1996A0	M5X35 SCREW	7	PZ	VM1794A0	250X4.8 PA66 BLACK CLAMP	2	PZ	VM2103A0	CLAMP LOCK	2	PZ	VM2267A0	INTERNAL GLASS LOCKING SYSTEM SLIDER	1	PZ	VM2269A0	INTERNAL GLASS LOCKING SYSTEM CAP	1	PZ	VM2274A0	GROOVED BUSHING	1	PZ	VM2305A0	6 SERIES DOOR CAP FIXING PAWL	7	PZ	VM2384A0	LEFT MM DOOR LOWER RIGHT CAP	1	PZ	VM2386A1	LEFT MM DOOR LOWER LEFT CAP	1	PZ
Code	Description	Qty	UOM																																																			
OB1126A0	DOOR LOWER FRAME SHAPE 860 MM	1	PZ																																																			
RC1200A0	ED=4 WIRE D.=0.5 COMPRESSIO N SPRING	2	PZ																																																			
VI1220A1	4,2X12 TCB SELF-TAPPIN G SCREW	1	PZ																																																			
VI1996A0	M5X35 SCREW	7	PZ																																																			
VM1794A0	250X4.8 PA66 BLACK CLAMP	2	PZ																																																			
VM2103A0	CLAMP LOCK	2	PZ																																																			
VM2267A0	INTERNAL GLASS LOCKING SYSTEM SLIDER	1	PZ																																																			
VM2269A0	INTERNAL GLASS LOCKING SYSTEM CAP	1	PZ																																																			
VM2274A0	GROOVED BUSHING	1	PZ																																																			
VM2305A0	6 SERIES DOOR CAP FIXING PAWL	7	PZ																																																			
VM2384A0	LEFT MM DOOR LOWER RIGHT CAP	1	PZ																																																			
VM2386A1	LEFT MM DOOR LOWER LEFT CAP	1	PZ																																																			

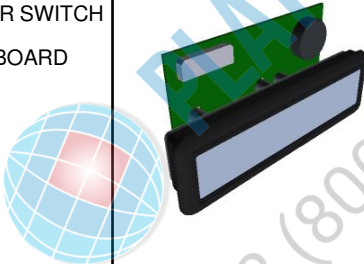

COMPONENT			SPARE PART																						
Code	Description	Image	Code	Description	Components list																				
0B1234A	XEBC-10EU LEFT EXT NEUTRAL DOOR COLUMN		0B1234A0	XEBC-10EU LEFT EXT NEUTRAL DOOR COLUMN																					
0B1219A	MM DOUBLE GLASS DOOR INT UPPER BEAM 860		0B1219A1	MM DOUBLE GLASS DOOR INT UPPER BEAM 860																					
PE2046A	MM POWER SWITCH AND USB BOARD		KPE2046A	MIND.MAPS USB-RESET SUPPORT KIT	<table border="1"> <thead> <tr> <th>Code</th> <th>Description</th> <th>Qty</th> <th>UOM</th> </tr> </thead> <tbody> <tr> <td>PE2046A0</td> <td>MM POWER SWITCH AND USB BOARD</td> <td>1</td> <td>PZ</td> </tr> <tr> <td>PE2046A1</td> <td>MM POWER SWITCH AND USB BOARD</td> <td>1</td> <td>PZ</td> </tr> <tr> <td>V11220A1</td> <td>4,2X12 TCB SELF-TAPPING SCREW</td> <td>2</td> <td>PZ</td> </tr> <tr> <td>VM2147A0</td> <td>ESD SPONGE PINK SMOOTH 410X343X15 M</td> <td>0.250</td> <td>PZ</td> </tr> </tbody> </table>	Code	Description	Qty	UOM	PE2046A0	MM POWER SWITCH AND USB BOARD	1	PZ	PE2046A1	MM POWER SWITCH AND USB BOARD	1	PZ	V11220A1	4,2X12 TCB SELF-TAPPING SCREW	2	PZ	VM2147A0	ESD SPONGE PINK SMOOTH 410X343X15 M	0.250	PZ
Code	Description	Qty	UOM																						
PE2046A0	MM POWER SWITCH AND USB BOARD	1	PZ																						
PE2046A1	MM POWER SWITCH AND USB BOARD	1	PZ																						
V11220A1	4,2X12 TCB SELF-TAPPING SCREW	2	PZ																						
VM2147A0	ESD SPONGE PINK SMOOTH 410X343X15 M	0.250	PZ																						
0B1170A	XEBC-10EU-E LEFT INT DOOR COLUMN																								
0B1172A	XEBC-10EU-E RIGHT INT DOOR COLUMN	